



OWNER'S MANUAL

2024 PROMASTER



ROADSIDE ASSISTANCE

24 HOURS, 7 DAYS A WEEK AT YOUR SERVICE. CALL 1-800-521-2779 OR VISIT CHRYSLER.RSAHELP.COM (USA) CALL 1-800-363-4869 OR VISIT FCA.ROADSIDEAID.COM (CANADA) SERVICES: Flat Tire Service, Out Of Gas/ Fuel Delivery, Battery Jump Assistance, Lockout Service and Towing Service

FCA US LLC reserves the right to modify the terms or discontinue the Roadside Assistance Program at any time. The Roadside Assistance Program is subject to restrictions and conditions of use, that are determined solely by FCA US LLC.

Please see the Customer Assistance chapter in this Owner's Manual for further information.

Vehicle images are for illustration purposes only. Actual products sold may vary.

This Owner's Manual illustrates and describes the operation of features and equipment that are either standard or optional on this vehicle. This manual may also include a description of features and equipment that are no longer available or were not ordered on this vehicle. Please disregard any features and equipment described in this manual that are not on this vehicle. FCA US LLC reserves the right to make changes in design and specifications, and/or make additions to or improvements to its products without imposing any obligation upon itself to install them on products previously manufactured.

With respect to any vehicles sold in Canada, the name FCA US LLC shall be deemed to be deleted and the name FCA Canada Inc. used in substitution therefore.

⚠ WARNING: Operating, servicing and maintaining a passenger vehicle or off-highway motor vehicle can expose you to chemicals including engine exhaust, carbon monoxide, phthalates, and lead, which are known to the State of California to cause cancer and birth defects or other reproductive harm. To minimize exposure, avoid breathing exhaust, do not idle the engine except as necessary, service your vehicle in a well-ventilated area and wear gloves or wash your hands frequently when servicing your vehicle. For more information go to www.P65Warnings.ca.gov/passenger-vehicle.



RAM
COMMERCIAL

TABLE OF CONTENTS

1	INTRODUCTION.....	7
2	GETTING TO KNOW YOUR VEHICLE	14
3	GETTING TO KNOW YOUR INSTRUMENT PANEL	64
4	STARTING AND OPERATING	87
5	MULTIMEDIA	136
6	SAFETY	151
7	IN CASE OF EMERGENCY.....	186
8	SERVICING AND MAINTENANCE	213
9	TECHNICAL SPECIFICATIONS.....	261
10	CUSTOMER ASSISTANCE.....	266
11	INDEX	272

1

2

3

4

5

6

7

8

9

10

11

INTRODUCTION

SYMBOLS KEY	8
VAN CONVERSIONS/CAMPERS	8
VEHICLE MODIFICATIONS/ALTERATIONS	8
Symbol Glossary	8

GETTING TO KNOW YOUR VEHICLE

HIGH VOLTAGE BATTERY	14
Battery Conditioning	15
HIGH VOLTAGE CHARGING OPERATION	16
SAE J1772 Charging Inlet	16
AC Level 1 Charging (120 Volt, 12 Amp)	16
AC Level 2 Charging (240 Volt, 32 Amp)	22
DC Charging	22
Vehicle Charge Indicators	23
Electric Vehicle App	24
KEYS	26
Key Fob	26
SENTRY KEY	28
IGNITION SWITCH	29
Keyless Enter 'n Go™ Ignition	29
REMOTE START — IF EQUIPPED	30
How To Use Remote Start	30
To Exit Remote Start Mode	31
Remote Start Defrost Mode Activation — If Equipped	31
Remote Start Comfort Systems — If Equipped	31
Remote Start Windshield Wiper De-Icer Activation — If Equipped	32
Remote Start Abort Message	32

REMOTE START SYSTEM (BEV) — IF EQUIPPED	32
How To Use Remote Start	32
To Exit Remote Start Mode	33
Scheduled Cabin Conditioning (SCC)	33
VEHICLE SECURITY SYSTEM — IF EQUIPPED	34
To Arm The System	34
To Disarm The System	34
Rearming Of The System	35
Security System Manual Override	35
DOORS	35
Power Door Locks	35
Auto Unlock Doors — If Equipped	36
Keyless Enter 'n Go™ — Passive Entry	36
Pocket Door (BEV Models) — If Equipped	37
Roll-Up Door — If Equipped	37
STEERING WHEEL	38
Telescoping Steering Column	38
Heated Steering Wheel — If Equipped	39
SEATS	39
Manual Adjustments	39
Heated Seats — If Equipped	41
Fold Down Tray — If Equipped	42
Adjustable Armrests — If Equipped	42
Head Restraints	43
UCONNECT VOICE RECOGNITION — IF EQUIPPED	44
Introducing Voice Recognition	44
Basic Voice Commands	44
Get Started	44
Additional Information	45
MIRRORS	45
Inside Rearview Mirror	45
Outside Mirrors	46

Outside Mirrors With Turn Signal And Approach Lighting — If Equipped	46
Power Mirrors — If Equipped	46
Power Folding Outside Mirrors — If Equipped	47
Heated Mirrors — If Equipped	47
EXTERIOR LIGHTS	47
Multifunction Lever	47
Headlights	47
Daytime Running Lights (DRLs) — If Equipped	48
High/Low Beam Switch	48
Automatic High Beam Headlamp Control — If Equipped	48
Flash-To-Pass	48
Automatic Headlights — If Equipped	48
Automatic Headlights With Wipers	49
Parking Lights	49
Headlight Delay	49
Fog Lights — If Equipped	49
Turn Signals	50
Lane Change Assist	50
Battery Saver	50
INTERIOR LIGHTS	50
Courtesy Lights	50
Illuminated Entry — If Equipped	52
WIPERS AND WASHERS	52
Windshield Wiper Operation	52
Rain Sensing Wipers — If Equipped	53
CLIMATE CONTROLS	54
Manual Climate Control Descriptions And Functions	54
Additional Rear Climate Control — If Equipped	56
Operating Tips	56

INTERIOR STORAGE AND EQUIPMENT	57	Change Engine Oil — If Equipped	71	AUTOMATIC TRANSMISSION	91
Storage	57	Main Menu	71	Ignition Park Interlock (Keyless Vehicle)	92
USB Control — If Equipped	58	WARNING LIGHTS AND MESSAGES	77	Brake/Transmission Shift Interlock	
Power Outlets	58	Red Warning Lights	77	(BTSI) System	92
Power Inverter — If Equipped	59	Yellow Warning Lights	80	9-Speed Automatic Transmission	92
Auxiliary Switches — If Equipped	60	Yellow Indicator Lights	83	AUTOMATIC TRANSMISSION — BEV (IF EQUIPPED)	95
Wireless Charging Pad — If Equipped	60	Green Indicator Lights	83	Ignition Park Interlock	96
WINDOWS	61	Blue Indicator Lights	84	Brake/Transmission Shift Interlock (BTSI)	
Power Windows	61	White Indicator Lights	84	System	96
Manual Sliding Window — If Equipped	62	ONBOARD DIAGNOSTIC SYSTEM — OBD II	85	BEV Transmission	96
Window Bar Grates — If Equipped	62	Onboard Diagnostic System (OBD II)		Gear Ranges	96
Wind Buffeting	62	Cybersecurity	85	POWER STEERING	97
HOOD	62	EMISSIONS INSPECTION AND MAINTENANCE		ACTIVE SPEED LIMITER — IF EQUIPPED	98
Opening	62	PROGRAMS	85	Activation	98
Closing	63	STARTING AND OPERATING		Exceeding The Set Speed	98
CARGO AREA FEATURES	63	STARTING THE ENGINE	87	Deactivation	98
GETTING TO KNOW YOUR INSTRUMENT PANEL		Automatic Transmission	87	INTELLIGENT SPEED ASSIST (ISA) — IF EQUIPPED	98
BASE / MIDLINE INSTRUMENT CLUSTER	64	Normal Starting	87	Activation	98
Base / Midline Instrument Cluster		Tip Start Feature	87	Exceeding The Set Speed	99
Descriptions	65	Cold Weather Operation		Deactivation	99
PREMIUM INSTRUMENT CLUSTER	66	(Below -22 °F Or -30 °C)	87	CRUISE CONTROL SYSTEMS — IF EQUIPPED	99
Premium Instrument Cluster Descriptions	67	Extended Park Starting	87	Adaptive Cruise Control (ACC)	99
PREMIUM INSTRUMENT CLUSTER — BEV (Battery Electric Vehicle)	68	If Engine Fails To Start	87	TRAFFIC SIGN ASSIST SYSTEM — IF EQUIPPED	106
Premium Instrument Cluster Descriptions —		After Starting	88	Activation/Deactivation	106
BEV	69	STARTING THE VEHICLE — BEV (IF EQUIPPED)	88	Traffic Sign Assist Modes	106
INSTRUMENT CLUSTER DISPLAY	69	Normal Starting	88	Indications On The Display	106
Location And Controls	69	ENGINE BLOCK HEATER — IF EQUIPPED	88	ACTIVE DRIVING ASSIST SYSTEM — IF EQUIPPED	107
Stop Safely Vehicle Will Shut Off Soon	70	ENGINE BREAK-IN RECOMMENDATIONS	89	Operation	107
Stop Safely And Leave The Vehicle As Soon As		PARKING BRAKE	89	Turning Active Driving Assist On Or Off	108
Possible	70	Electric Park Brake (EPB)	89	Indications On The Display	109

PARKSENSE FRONT/REAR PARK ASSIST —

IF EQUIPPED	111
ParkSense Sensors	111
ParkSense Warning Display	111
ParkSense Display	112
Enabling And Disabling ParkSense	114
Service The ParkSense Park Assist System	114
ParkSense Park Assist Failure Indications	114
Cleaning The ParkSense System	114
ParkSense Park Assist System Usage	
Precautions	114
Side Distance Warning System	115
Rear Emergency Braking (BEV Models)	117

PARKSENSE ACTIVE PARK ASSIST SYSTEM

(GAS MODELS) — IF EQUIPPED	117
Enabling And Disabling The ParkSense Active Park Assist System	118
Parallel/Perpendicular Parking Space Assistance Operation	119
Exiting The Parking Space	121

LANESENSE — IF EQUIPPED

LANESENSE — IF EQUIPPED	121
LaneSense Operation	121
Turning LaneSense On Or Off	122
LaneSense Warning Message	122
Changing LaneSense Status	123

PARKVIEW REAR BACK UP CAMERA

PARKVIEW REAR BACK UP CAMERA	123
---	------------

SURROUND VIEW CAMERA SYSTEM —**IF EQUIPPED**

SURROUND VIEW CAMERA SYSTEM — IF EQUIPPED	124
Refueling The Vehicle	126
Loose Fuel Filler Cap Message	127

VEHICLE LOADING

VEHICLE LOADING	127
Vehicle Certification Label	127
Gross Vehicle Weight Rating (GVWR)	127

Gross Axle Weight Rating (GAWR)	127
Tire Size	127
Rim Size	127
Inflation Pressure	127
Curb Weight	128
Overloading	128
Loading	128

TRAILER TOWING

TRAILER TOWING	128
Common Towing Definitions	128
Trailer Hitch Classification	129
Trailer Towing Weights (Maximum Trailer Weight Ratings)	130
Trailer And Tongue Weight	130
Towing Requirements	131
Towing Tips	132

RECREATIONAL TOWING

RECREATIONAL TOWING (BEHIND MOTORHOME)	133
Towing This Vehicle Behind Another Vehicle	133
Recreational Towing	133

DRIVING TIPS

DRIVING TIPS	134
Driving On Slippery Surfaces	134
Driving Through Water	134

MULTIMEDIA**UCONNECT SYSTEMS****CYBERSECURITY****UCONNECT SETTINGS**

UCONNECT SYSTEMS	136
CYBERSECURITY	136
UCONNECT SETTINGS	136
Customer Programmable Features	137

RADIO OPERATION AND MOBILE PHONES

RADIO OPERATION AND MOBILE PHONES	150
Regulatory And Safety Information	150
MPEG License Agreement	150

SAFETY**SAFETY FEATURES**

SAFETY FEATURES	151
Anti-Lock Brake System (ABS)	151
Regenerative Braking System (RBS) — BEV (If Equipped)	151
Audible Pedestrian Warning System — BEV (If Equipped)	151
Electronic Brake Control (EBC) System	152

AUXILIARY DRIVING SYSTEMS

AUXILIARY DRIVING SYSTEMS	155
Blind Spot Monitoring (BSM) — If Equipped	155
Drowsy Driver Detection (DDD) — If Equipped	160
Forward Collision Warning (FCW) With Mitigation — If Equipped	160
Tire Pressure Monitoring System (TPMS)	164

OCCUPANT RESTRAINT SYSTEMS

OCCUPANT RESTRAINT SYSTEMS	165
Occupant Restraint Systems Features	165
Important Safety Precautions	165
Seat Belt Systems	166
Supplemental Restraint Systems (SRS)	171
Child Restraints	177
Rear Bench Seat — If Equipped	180

SAFETY TIPS

SAFETY TIPS	183
Transporting Passengers	183
Transporting Pets	183
Connected Vehicles	183
Safety Checks You Should Make Inside The Vehicle	183
Periodic Safety Checks You Should Make Outside The Vehicle	184
Exhaust Gas	185
Carbon Monoxide Warnings	185

IN CASE OF EMERGENCY

HAZARD WARNING FLASHERS	186
SOS AND ASSIST SYSTEM	186
JACKING AND TIRE CHANGING — IF EQUIPPED	189
Preparations For Jacking	189
Jack And Tools Location	189
Spare Tire Removal	190
Jacking Instructions	192
Wheel Covers	194
TIRE SERVICE KIT — IF EQUIPPED	194
Alternate Tire Service Kit — If Equipped	199
Tire Service Kit Components And Operation	199
Tire Service Kit Usage Precautions	200
Sealing A Tire With Tire Service Kit	200
JUMP STARTING — GAS MODELS	203
Preparations For Jump Start — Gas Models	203
Jump Starting Procedure — Gas Models	203
Battery Location	204
JUMP STARTING — BEV MODELS	205
Preparations For Jump Start — BEV Models	205
Jump Starting Procedure — BEV Models	206
Battery Location	207
IF YOUR ENGINE OVERHEATS	207
GEAR SELECTOR OVERRIDE	208
FREEDING A STUCK VEHICLE	208
TOWING A DISABLED VEHICLE	209
Automatic Transmission	210
ENHANCED ACCIDENT RESPONSE SYSTEM (EARS)	212
EVENT DATA RECORDER (EDR)	212

SERVICING AND MAINTENANCE

SCHEDULED SERVICING	213
Maintenance Plan	213
ENGINE COMPARTMENT	216
3.6L Engine	216
Checking Oil Level	217
Adding Washer Fluid	217
Maintenance-Free Battery	217
Pressure Washing	218
Engine Compartment — BEV (if equipped)	219
VEHICLE MAINTENANCE	220
Engine Oil	220
Engine Oil Filter	220
Engine Air Cleaner, Filter	220
Air Conditioner Maintenance	221
Body Lubrication	222
Windshield Wiper Blades	223
Exhaust System	223
Cooling System	224
Brake System	226
Automatic Transmission	227
Fuses	227
Bulb Replacement	240
TIRES	244
Tire Safety Information	244
Tires — General Information	250
Tire Types	253
Spare Tires — If Equipped	253
Wheel And Wheel Trim Care	254
Snow Traction Devices	255
Tire Rotation Recommendations	256

DEPARTMENT OF TRANSPORTATION UNIFORM

TIRE QUALITY GRADES	256
Treadwear	257
Traction Grades	257
Temperature Grades	257
STORING THE VEHICLE	257
BODYWORK	258
Protection From Atmospheric Agents	258
Body And Underbody Maintenance	258
Preserving The Bodywork	258
INTERIORS	259
Seats And Fabric Parts	259
Plastic And Coated Parts	259
Leather Surfaces	259
Glass Surfaces	260

TECHNICAL SPECIFICATIONS

VEHICLE IDENTIFICATION NUMBER (VIN)	261
BRAKE SYSTEM	261
WHEEL AND TIRE TORQUE SPECIFICATIONS	261
Torque Specifications	261
FUEL REQUIREMENTS	262
3.6L Engine	262
Reformulated Gasoline	262
Materials Added To Fuel	262
Gasoline/Oxygenate Blends	262
Do Not Use E-85 In Non-Flex Fuel Vehicles	263
CNG And LP Fuel System Modifications	263
MMT In Gasoline	263
Fuel System Cautions	263

FLUID CAPACITIES	264
FLUID CAPACITIES — BEV (IF EQUIPPED)	264
ENGINE FLUIDS AND LUBRICANTS	265
CHASSIS FLUIDS AND LUBRICANTS	265

CUSTOMER ASSISTANCE

SUGGESTIONS FOR OBTAINING SERVICE FOR YOUR VEHICLE	266
Prepare For The Appointment	266
Prepare A List	266
Be Reasonable With Requests	266
IF YOU NEED ASSISTANCE	266
Roadside Assistance	266
FCA US LLC Customer Center	267
FCA Canada Customer Care	267
Mexico	267
Puerto Rico And US Virgin Islands	267
Customer Assistance For The Hearing Or Speech Impaired (TDD/TTY)	267
Service Contract	267
Warranty Information	268
MOPAR® PARTS	268
REPORTING SAFETY DEFECTS	268
In The 50 United States And Washington, D.C.	268
In Canada	269
ORDERING AND ACCESSING ADDITIONAL OWNER'S INFORMATION	269
CHANGE OF OWNERSHIP OR ADDRESS	269
GENERAL INFORMATION	269

INTRODUCTION

Dear Customer,



Congratulations on the purchase of your new Ram. Be assured that it represents precision workmanship, distinctive styling, and high quality.

This Owner's Manual has been prepared with the assistance of service and engineering specialists to acquaint you with the operation and maintenance of your vehicle. It is supplemented by customer-oriented documents. Within this information, you will find a description of the services that FCA US LLC offers to its customers as well as the details of the terms and conditions for maintaining its validity. Please take the time to read all of these publications carefully before driving your vehicle for the first time. Following the instructions, recommendations, tips, and important warnings in this manual will help ensure safe and enjoyable operation of your vehicle. Be sure you are familiar with all vehicle controls, particularly those used for braking, steering, transmission, and transfer case shifting (if equipped). Learn how your vehicle handles on different road surfaces. Your driving skills will improve with experience.

This Owner's Manual describes all versions of this vehicle. Options and equipment dedicated to specific markets or versions are not expressly indicated in the text. Therefore, you should only consider the information that is related to the trim level, engine, and version that you have purchased. Any content introduced throughout the Owner's Information, which may or may not be applicable to your vehicle, will be identified with the wording "If Equipped". All data contained in this publication are intended to help you use your vehicle in the best possible way. FCA US LLC aims at a constant improvement of the vehicles produced. For this reason, it reserves the right to make changes to the model described for technical and/or commercial reasons. For further information, contact an authorized dealer.

When it comes to service, remember that authorized dealers know your Ram best, have factory-trained technicians, genuine Mopar® parts, and care about your satisfaction.

SYMBOLS KEY

WARNING!	These statements apply to operating procedures that could result in a collision, bodily injury and/or death.
CAUTION!	These statements apply to procedures that could result in damage to your vehicle.
NOTE:	A suggestion which will improve installation, operation, and reliability. If not followed, may result in damage.
TIP:	General ideas/solutions/suggestions on easier use of the product or functionality.
PAGE REFERENCE ARROW 	Follow this reference for additional information on a particular feature.
FOOTNOTE 	Supplementary and relevant information pertaining to the topic.

If you do not read the entire Owner's Manual, you may miss important information. Observe all Cautions and Warnings.

VAN CONVERSIONS/CAMPERS

The New Vehicle Limited Warranty does not apply to body modifications or special equipment installed by van conversion/camper manufacturers/body builders. US residents refer to the Warranty Information, Section 2.1.C. Canadian residents refer to the

"What Is Not Covered" section of the Warranty Information. Such equipment includes video monitors, DVD/Blu-Ray™, heaters, stoves, refrigerators, etc. For warranty coverage and service on these items, contact the applicable manufacturer.

Operating instructions for the special equipment installed by the conversion/camper manufacturer should also be supplied with your vehicle. For any additional instructions, please contact your conversion/camper manufacturer.

To obtain dimensional and technical specifications for your vehicle, refer to the Body Builder's Guide at <https://www.ramtrucks.com/ram-commercial/body-builders-guide.html>.

VEHICLE MODIFICATIONS/ALTERATIONS

WARNING!

Any modifications or alterations to this vehicle could seriously affect its roadworthiness and safety and may lead to a collision resulting in serious injury or death.

Symbol Glossary

Some car components have colored labels with symbols indicating precautions to be observed when using this component. It is important to follow all warnings when operating your vehicle. See below for the definition of each symbol → page 77.







NOTE:







Warning and Indicator lights are different based upon equipment options and current vehicle status. Some telltales are optional and may not appear.







Red Warning Lights















Air Bag Warning Light
→ page 77







Red Warning Lights	
	Battery Charge Warning Light ↔ page 78
	Brake Warning Light ↔ page 77
	Door Open Warning Light ↔ page 78
	Drowsy Driver Detected Warning Light ↔ page 78
	Electronic Throttle Control (ETC) Warning Light ↔ page 78
	Electric Power Steering (EPS) Fault Warning Light ↔ page 78

Red Warning Lights	
	Electric System Fail ↔ page 78
	Engine Temperature Warning Light ↔ page 78
	Generic Warning Light ↔ page 79
	Hood Open Warning Light ↔ page 79
	Oil Pressure Warning Light ↔ page 79
	Rear Cargo Door Warning Light ↔ page 79

Red Warning Lights	
	Seat Belt Reminder Warning Light ↪ page 79
	Swivel Seat (Driver or Passenger) Unlocked Warning Light ↪ page 80
	Traction Battery Fault Warning Light ↪ page 80
	Torque Limited Warning Light ↪ page 79
	Transmission Fault Warning Light ↪ page 79
	Vehicle Security Warning Light ↪ page 80





Yellow Warning Lights	
	Acoustic Vehicle Alerting System (AVAS) Fault Warning Light ↪ page 80
	Adaptive Cruise Control (ACC) Fault Warning Light ↪ page 80
	Anti-Lock Brake System (ABS) Warning Light ↪ page 80
	Audio System Failure Warning Light ↪ page 80
	Drowsy Driver Detected System Fault Warning Light ↪ page 80
	Electronic Stability Control (ESC) Warning Light ↪ page 80





Yellow Warning Lights	
	Electronic Stability Control (ESC) OFF Warning Light ↪ page 81
	Engine Check/Malfunction Indicator Warning Light (MIL) ↪ page 81
	Immobilizer Fail / VPS Electrical Alarm Warning Light ↪ page 80
	Low Fuel Warning Light ↪ page 81
	Service Forward Collision Warning (FCW) Light ↪ page 81
	Service Required/Call For Service Warning Light ↪ page 81





Yellow Warning Lights	
	Service Active Lane Management Warning Light ↪ page 81
	Speed Limiter Fail Warning Light ↪ page 81
	Swivel Seat (Driver or Passenger) Fail Warning Light ↪ page 82
	Tire Pressure Monitoring System (TPMS) Warning Light ↪ page 82
	Towing Hook Breakdown Warning Light ↪ page 82
	Traction Battery Cut-off Warning Light ↪ page 82

Yellow Warning Lights	
	<p>Transmission Temperature Warning Light ↪ page 83</p>





Yellow Indicator Lights	
	<p>TOW/HAUL Indicator Light ↪ page 83</p>

Yellow Indicator Lights	
	<p>Exterior Lights Failure Indicator Light ↪ page 83</p>
	<p>Fuel Cutoff Failure Indicator Light ↪ page 83</p>
	<p>Forward Collision Warning (FCW) OFF Indicator Light ↪ page 83</p>
	<p>Keyless System Failure Indicator Light ↪ page 83</p>
	<p>Rain Sensor Failure Indicator Light ↪ page 83</p>

Green Indicator Lights	
	<p>Active Lane Management Indicator Light ↪ page 83</p>
	<p>Active Speed Limiter Set Indicator Light ↪ page 83</p>
	<p>Automatic High Beam Indicator Light ↪ page 84</p>
	<p>Cruise Control Indicator Light ↪ page 84</p>
	<p>Front Fog Indicator Light ↪ page 84</p>

Green Indicator Lights	
	Parking/Headlights On Indicator Light ↔ page 84
	Plug Status Indicator Light ↔ page 84
	Ready To Drive Indicator Light ↔ page 84
	Turn Signal/Hazard Warning Indicator Lights ↔ page 84

Blue Indicator Lights	
	High Beam Indicator Light ↔ page 84

White Indicator Lights	
	Adaptive Cruise Control (ACC) Set With Target Indicator Light ↔ page 84
	Active Lane Management Indicator Light ↔ page 84
	Active Speed Limiter Ready Indicator Light ↔ page 85
	Speed Warning Indicator Light ↔ page 85

GETTING TO KNOW YOUR VEHICLE

HIGH VOLTAGE BATTERY

Your vehicle is equipped with a Lithium-ion high voltage battery that is used to power the electric powertrain systems and the 12 Volt vehicle electrical system.

The high voltage battery is located under the middle section of the vehicle, below and in front of the second row seating. The high voltage battery is maintenance free and designed to last for the life of the vehicle.

Lithium-ion batteries provide the following benefits:

- Lithium-ion batteries are much lighter than other types of rechargeable batteries of the same size.
- Lithium-ion batteries hold their charge; they only lose approximately three percent of their charge per month.
- Lithium-ion batteries have no memory, which means that you do not have to completely discharge them before recharging, as with some other batteries.
- Lithium-ion batteries can be recharged and discharged thousands of times.

High Voltage Battery Service Disconnect

The high voltage battery service disconnect is located under the access panel, under the front passenger seat. Only a qualified service technician should access the high voltage battery service disconnect.

If your vehicle requires high voltage battery service, see an authorized dealer.

WARNING!

- Never try to remove the high voltage battery service disconnect. The high voltage battery service disconnect is used when your vehicle requires service by a qualified technician at an authorized dealership. Failure to follow this warning can result in electrical shock, toxic emissions, fire, and other hazards which can cause death or serious injury including severe burns, respiratory injuries, and blindness.
- The high voltage battery and battery case have no parts that you or an unqualified technician can service. Under no circumstances should you or an unqualified technician open, disassemble, penetrate, or tamper with the high voltage battery, battery case, their cables, or connectors. Damage to these components can result in electrical shock, toxic emissions, fire, and other hazards which can cause death or serious injury including severe burns, respiratory injuries, and blindness. You should take the vehicle to an authorized dealership for any service or maintenance on these high voltage components.
- The high voltage system can be hot during and after starting, and when the vehicle is shut off or charging. Be careful of both the high voltage and the high temperature. Failure to do so can result in severe burns.

Disposal of the High Voltage Battery

Your vehicle's high voltage battery is designed to last the life of your vehicle. See an authorized dealer for information on the disposal of the battery if it should require replacement.

WARNING!

Your vehicle contains a sealed Lithium-ion high voltage battery. If the battery is disposed of improperly, there is a risk of electrical shock and toxic emissions which can cause severe burns, respiratory injuries, fires, and other hazards resulting in serious injury or death.

General Information

The vehicle is also equipped with a Battery Management system that is designed to:

- Ensure safe operation
- Maximize driving range
- Maximize the life expectancy of the high voltage battery

NOTE:

- During vehicle start up and shut down, a clicking noise may be heard from within the vehicle. When the ignition is in the ON/RUN position, the high voltage battery contactors inside the battery are closed to make the stored electricity inside available for vehicle use. After the vehicle is shut down, the con-

tactors open to electrically isolate the battery from other vehicle systems. The clicking noise is the sound of these contactors as they open and close during normal operation.

- The Audible Pedestrian Warning system will emit a noise from the front of the vehicle when driving forward at speeds below 22 mph (35 km/h). It will also emit a noise from the rear of the vehicle when in REVERSE, and from both the front and rear of the vehicle when in NEUTRAL. For more information on this system, see  page 151.

WARNING!

In the event of a collision:

- If your vehicle is still drivable, pull off to the side of the road, when safe to do so, and place the transmission in the PARK position, apply the parking brake, and turn the vehicle off.
- Beware of any exposed high-voltage parts or cables. To avoid electrical shock which can result in serious injury or death, never touch wiring, connectors, and other high-voltage parts, such as the inverter unit and the Lithium-ion battery.
- Leaks or damage to the Lithium-ion battery may result in a fire and toxic emissions which can cause severe burns, respiratory injuries, and other serious injuries or death. If you discover these leaks, contact emergency services immediately. Since the fluid leak may be Lithium Manganate from the Lithium-ion battery, never touch the fluid leak inside or outside of the vehicle. If the fluid contacts your skin or eyes, wash these areas immediately with a large amount of water and obtain immediate medical attention to help avoid serious injury.

(Continued)

WARNING!

- If a fire occurs inside your vehicle, leave the vehicle as soon as possible. Only use a type ABC, BC, or C fire extinguisher that is meant for use on electrical fires. Using a small amount of water, or the incorrect fire extinguisher can result in serious injury or death from electrical shock.
- If you are not able to safely assess the vehicle due to vehicle damage, do not touch the vehicle. Leave the vehicle and contact emergency services. Advise first responders that this is a electric vehicle.
- In the event of an accident that requires bodywork, refer to an authorized dealership.

BATTERY CONDITIONING

In extreme temperatures, high or low, the high voltage battery may need to be conditioned, and therefore may require the vehicle to be plugged in.

If the ambient temperature is 5 °F (-15 °C) or below at vehicle shut down, the instrument cluster will display the message “Plug In Vehicle To Keep Battery Conditioned”.

If the battery temperature is below -22 °F (-30 °C), or 131 °F (55 °C) or above, the vehicle will NOT start:

- If the vehicle is plugged in at these battery temperatures, the instrument cluster will display the message “Please Leave Key In RUN – Battery Conditioning Needed”.

- If the vehicle is not plugged in at these battery temperatures, the “Plug In Vehicle To Condition Battery” will be shown in the instrument cluster display.
- If the battery temperature is below -27 °F (-33 °C), the message “Please Leave Key In RUN – Battery Conditioning Needed” will be displayed whether the vehicle is plugged in or not.

NOTE:

- When the “Please Leave Key In RUN – Battery Conditioning Needed” message is displayed, keep the ignition in the RUN position for the battery to recover. Place the ignition back in the OFF position when the message disappears, and then start the vehicle. When this message is displayed, do not operate any air conditioning controls.
- Under these high or low temperatures, if the vehicle is plugged in, and the ignition is in the OFF position, the vehicle may “wake up” to precondition the high voltage battery for use.
- It is recommended that the vehicle be plugged in overnight when possible to maximize the electric range of the vehicle.

The messages will only be displayed when the ignition is in the ON/RUN position and the high voltage battery is not ready to provide propulsion power. The message also displays if there is a failed attempt to achieve READY state when the high voltage battery cell temperatures are either too cold or too hot.

HIGH VOLTAGE CHARGING OPERATION

SAE J1772 CHARGING INLET

Your vehicle uses an industry standard SAE J1772 charge inlet (vehicle charge inlet) for AC Level 1 (120 V), AC Level 2 (240 V), and DC Fast Charge (350 V) charging.

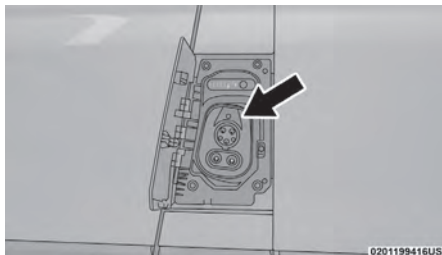

Vehicle Charge Inlet

Open the charge port door by pushing near the rear outer edge of the door, near the center to unlatch. To close the charge port door, engage the door latch by pushing on the rear outer edge near the center.

AC LEVEL 1 CHARGING (120 VOLT, 12 AMP)

Your vehicle may be equipped with a 120 Volt AC, SAE J1772 Level 1 Electric Vehicle Supply Equipment (EVSE), also referred to as a Portable Charging Cordset (EVSE). AC Level 1 charging requires a conventional NEMA 5-15R 120 Volt AC grounded wall outlet along with the Portable Charging Cordset (EVSE) provided with the vehicle.

WARNING!

Please be sure to follow these warnings. Failure to do so may result in serious injury or death.

- Discontinue use of the Portable Charging Cordset (EVSE) immediately if the plug or outlet becomes hot to the touch or if you notice any unusual odors.
- Do not use the Portable Charging Cordset (EVSE) in building structures that use fuse-based circuit protection. Use only with electrical circuits protected by circuit breakers.
- Do not use the Portable Charging Cordset (EVSE) if other devices are plugged into the same circuit.
- When unplugging the Portable Charging Cordset (EVSE) from the wall outlet, be sure to pull by the plug, and not the cord.
- Do not pull, twist, bend, step on or drag the cord of the Portable Charging Cordset (EVSE).
- Stop using the Portable Charging Cordset (EVSE) immediately if charging stops before it's completed when the plug or cord is moved or adjusted.
- Do not use the Portable Charging Cordset (EVSE) if the plug has a loose connection with the wall outlet or if the wall outlet is damaged or rusted.
- If in any doubt about the wall outlet and/or circuit, contact a qualified electrician.
- Do not use if a malfunction occurs or if the Portable Charging Cordset has been damaged in any manner. It is recommended that you contact an authorized dealership.

(Continued)

WARNING!

- There are no user serviceable parts inside the Portable Charging Cordset (EVSE). Do not attempt to repair or service the Portable Charging Cordset (EVSE), doing so will void the New Vehicle Warranty.



0201199418US

Portable Charging Cordset (EVSE)

WARNING!

INSTRUCTIONS PERTAINING TO A RISK OF FIRE OR ELECTRIC SHOCK: Electrical shock, fire, and other serious hazards can occur if the Portable Charging Cordset (EVSE) is not used properly. This vehicle uses a high voltage current. Failure to follow the proper charging instructions in this publication can cause serious injury or death. There are no serviceable parts in the Portable Charging Cordset (EVSE). Do not open, disassemble, penetrate, or tamper with the

(Continued)

WARNING!

Portable Charging Cordset (EVSE). Failure to follow this warning can result in electrical shock, fire, property damage, and death or serious injury.

To access the Portable Charging Cordset (EVSE), open the door of the cargo area storage bin if equipped, on the driver's side, and remove the Portable Charging Cordset (EVSE) from the storage bag.

NOTE:

After use, the Portable Charging Cordset (EVSE) should be placed in the storage bag and put back in the cargo area storage bin if equipped. If the Portable Charging Cordset (EVSE) will be left outside the vehicle, be sure to protect the connection end from moisture, dirt, and debris accumulation and contamination.

NOTE:

The Portable Charging Cordset (EVSE) is used for AC Level 1 charging only.

WARNING!

IMPORTANT SAFETY INSTRUCTIONS PERTAINING TO A RISK OF FIRE OR ELECTRIC SHOCK: This publication contains important instructions and warnings that should be followed during charging operations. Failure to follow these warnings and instructions can result in electrical shock and fire which can cause death or serious injury.

- Read this entire publication before using the Portable Charging Cordset (EVSE).
- Do not put fingers or objects into the Portable Charging Cordset (EVSE) connector.

(Continued)

WARNING!

- Do not use the Portable Charging Cordset (EVSE) if the flexible power cord is frayed, broken, has cracked insulation, or any other signs of damage.
- Do not use the Portable Charging Cordset (EVSE) if the enclosure or the connector is broken, cracked, open, or shows any other indication of damage.
- Do not use the Portable Charging Cordset (EVSE) with an extension cord or plug adapters.
- The Portable Charging Cordset (EVSE) may attempt to reset and run after a power interruption.
- There are no user serviceable parts inside the Portable Charging Cordset (EVSE). Do not attempt to repair or service the Portable Charging Cordset (EVSE) yourself – personal injury may result.
- When using a charging station with the Portable Charging Cordset (EVSE) attached, ensure the charging station's cable is not visibly damaged before plugging into the vehicle.
- Do not allow children to operate the Portable Charging Cordset (EVSE). Adult supervision is mandatory when children are in proximity to the charge station that is in use.
- Do not use a charge station or vehicle charge inlet that is worn or damaged with the AC Level 2 charging cable. Plugging into worn or damaged receptacles may cause damage to the Portable Charging Cordset (EVSE) and vehicle.
- Ensure that the Portable Charging Cordset (EVSE) is always stored in a safe place. Do not expose the EVSE J1772 vehicle connector to rain or wet conditions. Avoid allowing water or other liquids to pour or drip onto the vehicle connection end of the J1772 EVSE connector. If water penetrates the

(Continued)

WARNING!

electrical device, the risk of electrical shock increases. Ensure that all plugs and cables are free of moisture before using the Portable Charging Cordset (EVSE).

- In a collision, a loose Portable Charging Cordset (EVSE) in the vehicle could cause injury. It could fly around in a sudden stop and strike someone in the vehicle. Do not store the Portable Charging Cordset (EVSE) on the cargo load floor, or in the passenger compartment.
- The Portable Charging Cordset (EVSE) has been tested for use in temperatures ranging from -40° F to 122° F (-40° C to 50° C).
- The Portable Charging Cordset (EVSE) should be stored at temperatures between -40° F and 176° F (-40° C and 80° C).
- SAVE THESE INSTRUCTIONS.

EVSE Charging Cordset

The Portable Charging Cordset (EVSE) is compliant with SAE J1772, and applicable for use with vehicles fitted with standard SAE J1772 charge inlets. The Portable Charging Cordset (EVSE) includes:

- A charge connector
- A NEMA 6 rated enclosure with a Charge Current Interrupt Device (CCID) with a status indicator display
- An AC Power Cord with a NEMA 5-15P right angle plug
- An indoor/outdoor charge cable, EV-rated
- A Status Indicator Display



Charging Cordset

- 1 – Charge Connector
- 2 – Status Indicator Display
- 3 – Charge Cable
- 4 – AC Plug

GROUNDING INSTRUCTIONS

For A Grounded, Cord-Connected Product:

The Portable Charging Cordset (EVSE) must be grounded. If it should malfunction or break down, grounding provides a path of least resistance for an electric current to reduce the risk of electric shock. The Portable Charging Cordset (EVSE) is equipped with a cord having an equipment-grounding conductor and a grounding plug. The plug must be plugged into an appropriate outlet that is properly installed and grounded in accordance with all local codes and ordinances.

WARNING!

INSTRUCTIONS PERTAINING TO A RISK OF FIRE OR ELECTRIC SHOCK: Do not use the Portable Charging Cordset (EVSE) on electrical circuits with two-prong outlets; use with improper outlets could result in electric shock, fire, property damage, and death or serious injury. Check with a qualified electrician if you are in doubt as to whether the wall outlet is properly grounded. Do not modify the plug prongs provided with the Portable Charging Cordset (EVSE) – if it does not fit the outlet, you must have a proper outlet installed by a qualified electrician.

Charging Cordset Operation

1. Insert the AC plug prongs of the Portable Charging Cordset (EVSE) into a 15 A, or 20 A, 120 VAC, 60 Hz, grounded wall outlet. Do not use an extension cord, outlet/plug adapter, or a worn outlet. The Portable Charging Cordset (EVSE) will not operate safely unless it is plugged directly into the wall outlet.

NOTE:

The Portable Charging Cordset (EVSE) should be plugged into a dedicated circuit, not a circuit shared with other devices drawing electricity on the circuit.

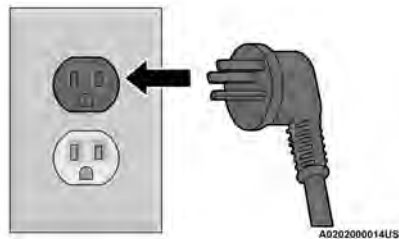

AC Plug And Wall Receptacle

WARNING!

INSTRUCTIONS PERTAINING TO A RISK OF FIRE OR ELECTRIC SHOCK: Do not use the Portable Charging Cordset (EVSE) on electrical circuits with two-prong outlets; use with improper outlets could result in electric shock, fire, property damage, and death or serious injury. Check with a qualified electrician if you are in doubt as to whether the wall outlet is properly grounded. Do not modify the plug prongs provided with the Portable Charging Cordset (EVSE) – if it does not fit the outlet, you must have a proper outlet installed by a qualified electrician.

2. Check to see if the Portable Charging Cordset (EVSE) is ready to charge by reviewing the indicator lights. After a brief self-check, where the indicator lights will flash, a green AC Power indicator light and two green Charge Active indicator lights indicate that the Portable Charging Cordset (EVSE) is ready for use.

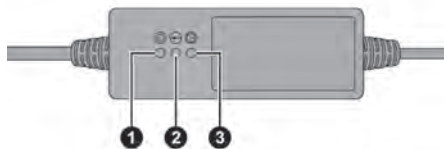

0201199425US

Cordset Indicator Lights

- 1 – AC Power Indicator Light
- 2 – Fault Indicator Light
- 3 – Charge Active Indicator Lights

3. If the Portable Charging Cordset (EVSE) is ready to charge, ensure the vehicle is in PARK, and then connect the charge connector to the vehicle's charge inlet. You will hear a "click" when the charge connector is inserted correctly and coupled with the vehicle's charge inlet.

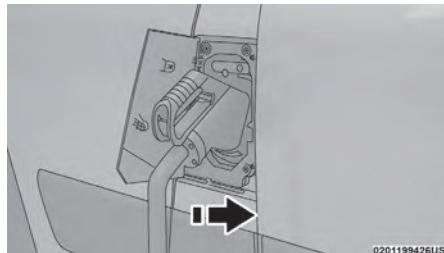

0201199426US

Inserting The Charge Connector Into The Vehicle Charge Inlet

4. When the vehicle commences charging, the Charge Active indicator lights on the Portable Charging Cordset (EVSE) will cycle from left to right, and then both turn off. This pattern will repeat while the vehicle is charging. The lights are illuminated at the rate of approximately one cycle per second.

NOTE:

The vehicle should start charging automatically. If not, please check the following:

- Portable Charging Cordset (EVSE) – The Portable Charging Cordset (EVSE) status indicators illuminate green or red to identify the charging status
 ➔ page 19.
 - Wall Outlet – Check whether the wall outlet is functional (no power outage) and/or plug the Portable Charging Cordset (EVSE) into a different wall outlet.
 - Charging Schedule – Check whether or not the charging schedules have been enabled. If enabled, check that you are within the scheduled time and day of the week. If a charging schedule has been enabled in the vehicle, and it is outside the time and day of the week, you may override the schedule for this charging event by plugging in the charge connector, unplugging it, and then plugging it back into the vehicle charge inlet. Complete the double plug sequence within 10 seconds for it to override the set schedule.
 - Hood Ajar – Check whether the hood is open. Charging is disabled while the hood is open, and will resume when the hood closes.
5. To stop the charging process, disconnect the Portable Charging Cordset (EVSE) from the vehicle first, and then from the wall outlet. To disengage the vehicle coupler, push the button on the connector.



Removing The Charge Connector From The Vehicle Charge Inlet

6. Close the inlet door when a Portable Charging Cordset (EVSE) is not connected to the vehicle.

NOTE:

It is good practice to keep the ignition in the OFF position while conducting Level 1 charging. This minimizes any additional vehicle loads the Portable Charging Cordset (EVSE) has to support. The additional electrical loads will extend the high voltage battery charging time.

Troubleshooting Using The Status Indicator Display

If the vehicle is not charging properly, consult the status indicator lights.

The **AC Power Indicator** displays the status and safety of the input power. If this indicator is green, the power is within acceptable limits to charge the vehicle. If only the AC Power Indicator is flashing red, then there is a problem with the AC power at the electrical outlet. If the AC Power Indicator does not return to green, then the outlet should be inspected by a qualified electrician to

ensure the voltage, frequency, and grounding are compliant to national and local electrical codes and ordinances. It may be possible to attempt charging from a different outlet.

The **Fault Indicator** displays the status of the Portable Charging Cordset (EVSE) and the vehicle connection. The Portable Charging Cordset (EVSE) will not allow charging while the fault indicator is red. If it is off, the Portable Charging Cordset (EVSE) has not detected any internal faults, or faults with the vehicle connection. If the Fault Indicator is flashing red, there is a fault detected either with the Portable Charging Cordset (EVSE), electronics, or with the vehicle connection. The Portable Charging Cordset (EVSE) may attempt to retry to provide current to the vehicle if the fault is cleared. If

the Portable Charging Cordset (EVSE) does not attempt to provide charge to the vehicle, the charge connector will need to be removed from the vehicle to clear the fault.

The fault code list in the following table provides a reference for the important faults that are detected by the Portable Charging Cordset (EVSE). When a fault is detected, the AC Power Indicator, the Fault Indicator, or both the AC Power and Fault Indicators will flash red. If only the AC Power Indicator is red, there is a problem on the AC Power side of the unit. If only the Fault Indicator is flashing red, there is a problem internal to the unit or with the vehicle. If both the AC Power and Fault Indicators are flashing red, an over temperature condition is detected at either the AC plug or within the Portable

Charging Cordset (EVSE) enclosure. Additional information about the faults is provided by a fault code that is displayed on the two green Charge Active Indicators. The fault code consists of four digits, each with a value of 1 or 2. The value of a digit is the number of indicators illuminated for that part of the sequence. For example, fault code (1, 2, 1, 1) will display the following sequence: One indicator will illuminate for 0.3 seconds, then two indicators will illuminate, then one indicator, and finally one indicator will illuminate. After all four fault code digits have been displayed, the indicators will remain off for one second before repeating the sequence.

Portable Charging Cordset (EVSE) Fault Code List

Flashing Fault Code	Flashing Indicator	Fault Indication	Recommended Actions
1, 2, 2, 2	AC Power	Vehicle Current Draw is Too High	Check Portable Charging Cordset (EVSE) and vehicle at an authorized dealership.
1, 1, 2, 1	AC Power	Incorrect Electrical Supply	Attempt to charge the vehicle at a different outlet. Contact a qualified electrician to check the electrical outlet and AC Supply (house wiring).
1, 1, 2, 2	AC Power	Incorrect Electrical Supply	Attempt to charge the vehicle at a different outlet. Contact a qualified electrician to check the electrical outlet and AC Supply (house wiring).
1, 2, 1, 1	AC Power	Incorrect Electrical Supply	Attempt to charge the vehicle at a different outlet. Contact a qualified electrician to check the electrical outlet and AC Supply (house wiring).
1, 2, 1, 2	AC Power	Incorrect Electrical Supply	Attempt to charge the vehicle at a different outlet. Contact a qualified electrician to check the electrical outlet and AC Supply (house wiring).
1, 1, 1, 1	Fault	Portable Charging Cordset (EVSE) Internal Fault	Unplug the Portable Charging Cordset (EVSE) from the vehicle charge inlet and retry to charge. If the issue is not corrected, check the Portable Charging Cordset (EVSE) and vehicle at an authorized dealership.
1, 1, 1, 2	Fault	Portable Charging Cordset (EVSE) Internal Fault	Unplug the Portable Charging Cordset (EVSE) from the vehicle charge inlet and retry to charge. If the issue is not corrected, check the Portable Charging Cordset (EVSE) and vehicle at an authorized dealership.

Portable Charging Cordset (EVSE) Fault Code List			
Flashing Fault Code	Flashing Indicator	Fault Indication	Recommended Actions
1, 2, 2, 1	AC Power	Outlet Wiring Bad Ground	Attempt to charge the vehicle at a different outlet. Contact a qualified electrician to check the electrical outlet and AC Supply (house wiring).
1, 2, 1, 1	Fault	Portable Charging Cordset (EVSE) Internal Fault	Check the Portable Charging Cordset (EVSE) and vehicle at an authorized dealership.
1, 2, 1, 2	Fault	CCID Leakage Current Detected	Disconnect charge connector and retry charging. If problem persists, check the Portable Charging Cordset (EVSE) and vehicle at an authorized dealership.
2, 2, 2, 1	Fault	Vehicle Interface Connector	Error with the Vehicle Charge Connector Interface — Check for water or other contamination in the vehicle charge inlet or charge connector.
2, 2, 2, 2	Fault	Vehicle Interface Connector	Error with the Vehicle Charge Connector Interface — Check for water or other contamination in the vehicle charge inlet or charge connector.
1, 1, 2, 1	Fault & AC Power	Portable Charging Cordset (EVSE) Enclosure Internal Temperature is Too High	Use caution as the Portable Charging Cordset (EVSE) housing may be hot. It is recommended to move the Portable Charging Cordset (EVSE) out of direct sun exposure. Allow the unit to cool. If error persists, check the Portable Charging Cordset (EVSE) at an authorized dealer.
1, 1, 1, 2	Fault & AC Power	Hot AC Power Plug Warning	Use caution as the Portable Charging Cordset (EVSE) AC Power Plug may be hot. It is recommended to carefully unplug the unit from the wall outlet and allow it to cool down. Attempt to charge the vehicle at a different wall outlet. Contact a qualified electrician to inspect/replace the wall outlet that was associated with the Hot AC Plug event. Charging will still occur, but at a reduced rate.
1, 1, 1, 1	Fault & AC Power	AC Power Plug Over Temperature	Use caution as the Portable Charging Cordset (EVSE) AC Power Plug may be hot. It is recommended to carefully unplug the unit from the wall outlet and allow it to cool down. Attempt to charge the vehicle at a different outlet. Contact a qualified electrician to inspect/replace the outlet that was associated with the Hot AC Plug event.

Guidelines for preventing fire and electric shock:

- Ensure the Portable Charging Cordset (EVSE) is positioned so it will not be stepped on, tripped over, or otherwise subjected to damage or stress.
- There are no user serviceable parts inside.
- Do not use the Portable Charging Cordset (EVSE) if it is visibly damaged. Contact an authorized dealership for service.
- Do not place fingers, or any other objects inside the charge connector.
- Do not allow children to operate the Portable Charging Cordset (EVSE). Adult supervision is mandatory when children are in proximity when the Portable Charging Cordset (EVSE) is in use.
- Do not use the Portable Charging Cordset (EVSE) with an extension cord or plug adapters.

- Do not unplug the Portable Charging Cordset (EVSE) from the wall outlet during a charging operation.

NOTE:

During normal operation, the charge connector or AC plug may feel warm. If either one feels hot during charging, unplug the Portable Charging Cordset (EVSE) and have a qualified electrician inspect the wall outlet before you continue charging ↪ page 266.

WARNING!

INSTRUCTIONS PERTAINING TO A RISK OF FIRE OR ELECTRIC SHOCK: Do not use the Portable Charging Cordset (EVSE) with an outlet that is worn or damaged. Failure to follow this warning can result in electrical shock, fire, property damage, and death or serious injury.

AC LEVEL 2 CHARGING (240 VOLT, 32 AMP)

AC Level 2 (240 V) charging requires a 240 V, Level 2 Electric Vehicle Supply Equipment (EVSE) charging station. A 32 Amp Level 2 EVSE for home installation is recommended. The Level 2 EVSE connects to a 40 Amp circuit breaker and delivers 32 Amp maximum to the vehicle.

When using public charging stations, ensure the charging station is ready to provide charge and the vehicle is in PARK before the Level 2 EVSE is plugged into the vehicle's charge inlet. You will hear a "click" when the charge connector is inserted correctly and is coupled with the vehicle's charge inlet.

NOTE:

The vehicle should start charging automatically. If not, please check the following:

- Charging Station — Check the indications and instructions at the charging station.
- Charging Schedule — Check whether the charging schedule is enabled and if so, whether the vehicle is currently within the scheduled charge time/day (weekday/weekend). If the charging schedule is enabled within the vehicle, you may override it for this charging event by plugging in the charge connector, unplugging it, and then plugging it back into the vehicle charge inlet. Complete the double plug sequence within 10 seconds for it to override the set schedule.
- Hood Ajar — Check whether the hood is open. Charging is disabled while the hood is open, and will resume when the hood closes.

To stop the charging process:

- Press the button located on the Level 2 EVSE vehicle connector.
- Remove the connector from the vehicle charge inlet.
- Plug the charge handle into the Level 2 EVSE station and coil the charging cord onto its holder. Do not leave the charging cord lying on the ground.

DC CHARGING

DC Charging is a significantly faster method of charging your vehicle either on the go or overnight. The DC charging cable plugs into the vehicle straight from the power outlet not needing the status indicator display. The power converter for the DC charging cord is within the charging cable.

When using public charging stations, ensure the charging station is ready to provide charge and the vehicle is in PARK before the charging cable is plugged into the vehicle's charge inlet. You will hear a "click" when the charge connector is inserted correctly and is coupled with the vehicle's charge inlet.

NOTE:

DC Charging can vary from high to low power depending on potential external factors such as weather and power supply.

NOTE:

Due to the convenience of DC Charging there may be a higher payment required depending on the charge station selected.

NOTE:

The vehicle should start charging automatically. If not, please check the following:

- Charging Station — Check the indications and instructions at the charging station.
- Charging Schedule — Check whether the charging schedule is enabled and if so, whether the vehicle is currently within the scheduled charge time/day (weekday/weekend). If the charging schedule is enabled within the vehicle, you may override it for this charging event by plugging in the charge connector, unplugging it, and then plugging it back into the vehicle charge inlet. Complete the double plug sequence within 10 seconds for it to override the set schedule.
- Hood Ajar — Check whether the hood is open. Charging is disabled while the hood is open, and will resume when the hood closes.

VEHICLE CHARGE INDICATORS

Instrument Cluster High Voltage Battery Display

There is a battery display indicator located on the instrument cluster. The battery display will indicate the current State Of Charge (SOC) for the high voltage battery; with the percentage value located to the right of the symbol. When plugged in, the battery symbol also indicates the battery level along with messages about the charge or whether the system is waiting to charge due to the charge schedule. These will appear unless there is a charging fault. A green plug telltale will be shown in the cluster, as well as applicable messaging when charging.



High Voltage Battery Display

Instrument Panel State Of Charge Indicator

In addition to the battery display in the instrument cluster, your vehicle is equipped with a visual SOC indicator. The SOC indicator is made up of five lights that are mounted to the top center of the instrument panel, which will illuminate when the vehicle is plugged into the charging system.



State Of Charge Indicator

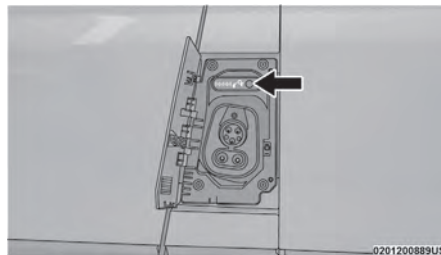

Charge Port SOC Indicator

The SOC indicator provides a visual indication of the high voltage battery's charge status during charging. It is also used to indicate a charging problem as well as waiting for a scheduled charge to begin.

NOTE:

The lights scroll one at a time when the vehicle is plugged in outside of its charging schedule time/day of the week, and it is waiting on the schedule to begin charging.

In extreme hot or cold environments, the lights on the SOC indicator may not illuminate. Charge status is available in the instrument cluster display. In the event of an error in the charging process, the outer two lights will blink.

When the hood is open, the lights on the SOC indicator will not be illuminated.

Number Of Indicator Lights Illuminated	Percent Of Battery Charge
1st light blinks	0 - 20%
1st light on, 2nd light blinks	21 - 40%
1st and 2nd lights on, 3rd light blinks	41 - 60%
1st, 2nd, and 3rd lights on, 4th light blinks	61 - 80%
1st, 2nd, 3rd, and 4th lights on, 5th light blinks	81 - 99%
All 5 lights on	100%
Two outer lights are blinking	Indicates an error in the charging process
Lights turn on one at a time from left to right (when looking at the front of the vehicle)	Indicates system is waiting for scheduled time in charge schedule to begin charging
All lights turn on, then immediately turn off	Indicates a successful plug-in

NOTE:

For each segment of lights illuminated indicating the percent of battery charge, two different blink rates are used. A blink rate of 1 second on/1 second off indicates that the first half is charging. The blink rate will increase to 0.5 second on/0.5 second off to indicate that the second half is charging. When the battery is fully charged, the blinking stops and the lights remain illuminated as charging continues.

ELECTRIC VEHICLE APP

Within the Uconnect system is the Electric Vehicle App that allows you to see your vehicle's power flow, understand your driving history, and set a charging schedule for your vehicle's high voltage battery. To access this App, press the Apps or Vehicle button on the main menu bar of the radio's touchscreen, and locate the Electric Vehicle App. Accessing the app brings you to a set of three pages: Power Flow, Driving History, Schedules, and AC Charging Level.

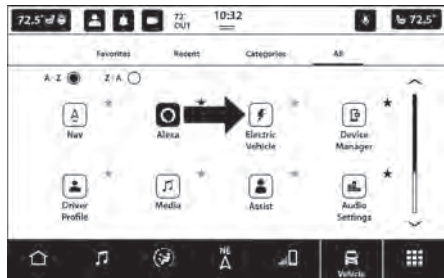
**Electric Vehicle App Location****Power Flow**

The Power Flow screen shows the current power readings for all of the following:

- Motor - Shows the amount of power (in kW) the high voltage battery is currently providing/absorbing.
- Climate - Shows the amount of power (in kW) the Climate Control system is using to maintain the current interior temperature.

Power Flow paths are indicated by the direction of the arrows on the touchscreen.

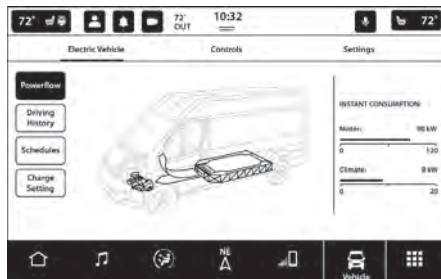
**Power Flow Screen****Driving History**

The Driving History screen shows the miles (km) driven in Full Electric kWh (battery powered) mode for both the previous week and the current week. The data is displayed in a bar graph: Electric mode in teal.

**Driving History Screen****Charging Schedule**

To set a charging schedule, select the Electric Vehicle App in the touchscreen and follow these steps:

1. Select "Schedules".

**Schedules Screen**

2. Select "Charge Schedule".

3. Select the schedule to be set (1, 2, or 3) by pressing the appropriate arrow on the right side of the screen.
4. Select what time Scheduled Charging should start and stop charging or select “Charge Until Full”. If “Charge Until Full” is selected a stop charging time cannot be selected.
5. Set the Charge Start Time: Hours, Minutes, and AM/PM.

NOTE:

This is to occur every week (as long as the vehicle is connected to an EVSE).

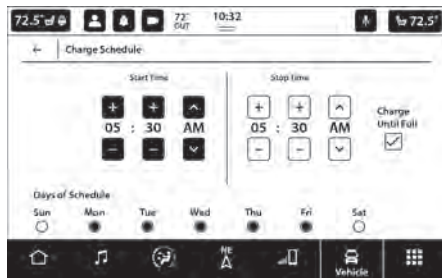
**Set Charge Schedule**

6. When done, press the X in the upper right hand corner, then select “yes” to save the charge schedule. The active schedule will be indicated by the check mark to the right of the schedule event line. The event action and time will be displayed.

7. To add another Scheduled Charging event, repeat these steps.

NOTE:

A maximum of three independent Scheduled Charging events can be scheduled at a given time.

NOTE:

- If the charging schedule is not enabled, the vehicle will charge whenever plugged in. It is not necessary to set up the charging schedule to charge the vehicle.
- If the vehicle is plugged in outside of the charging schedule set in the Uconnect system (and Charge Until Full is not selected), the vehicle’s battery will not charge. Charging will only begin immediately if the vehicle is plugged in within the time and day of the week set in the schedule. Otherwise, charging will automatically begin when the selected charge time/day of the week occurs or whenever the vehicle is plugged in with no charge schedule set.
- If the vehicle is turned off outside of the charging window, a radio pop-up message will be displayed, which provides an option to begin charging the vehicle immediately. The pop-up message asks the driver if they would like to “Charge Now?” and provides other information, including the next charging schedule start time and estimated time to charge the battery to 100%. If within one hour of selecting “Yes,” the vehicle is connected to a powered EVSE, the vehicle will immediately begin to charge (temporarily ignoring any set charge schedule). To fully deactivate the charge schedule, refer to the “Schedules” feature within the Electric Vehicle App.

- The charging schedule can also be overridden if an EVSE is plugged in, unplugged, and then plugged in a second time to the vehicle. This “double plug sequence” will override the schedule that is set in the radio, and begin charging the vehicle immediately. The double plug sequence must be completed within 10 seconds for it to override the programmed schedule.
- If “Charge Until Full” is selected, and the vehicle is plugged in after the start time of the schedule, the vehicle will start charging when it reaches the start time the next day. If you would like to begin charging immediately, and continue charging until the vehicle is fully charged, you can select the “Charge Now” option or use the double plug override option.

NOTE:

For information on jump starting your vehicle, page 203.

AC Charging Level — If Equipped

The fourth screen within the Electric Pages App is the AC Charging Level screen. From this screen, you can select the rate at which your vehicle charges. Rate selections 1 (low rate of charge) through 5 (high rate of charge) are available. The lower the selected rate, the longer it will take for your vehicle to reach a full charge.



Charge Setting Screen

The Charge Setting can be adjusted by selecting one of the levels 1 through 5, with 1 being the slowest rate of charge and 5 being the fastest. The display also shows information related to:

- Battery Level – Indicates, in percentage, the high-voltage battery SOC.
- Estimate time to 100% – Corresponds to the time required to obtain full recharging of the high-voltage battery.

NOTE:

- The Charge Setting will be saved each time the vehicle is turned off, then back on again.
- For information on jump starting your vehicle ↪ page 205.

KEYS

KEY FOB

Your vehicle is equipped with a key fob which supports Passive Entry, Remote Keyless Entry (RKE), Keyless Enter 'n Go™ (if equipped), and Remote Start (if equipped). The key fob allows you to lock or unlock all doors, as well as activate the Panic Alarm from distances up to approximately 66 ft (20 m). The key fob does not need to be pointed at the vehicle to activate the system. The key fob also contains an emergency key, which can be used by pushing the emergency key release button.

NOTE:

- The key fob's wireless signal may be blocked if the key fob is located next to a mobile phone, laptop, or other electronic device. This may result in poor performance.
- If your vehicle is equipped with a Wireless Charging Pad, the key fob may not be detected if it is placed within 6 inches (15 cm) of the pad ↪ page 60.
- With the ignition in the ON position and the vehicle moving at 2 mph (4 km/h), all RKE commands are disabled.



A0204000128US

Figure 1 - Keyless Ignition Key Fob

- 1 – Front Doors Unlock
- 2 – Cargo Unlock Button
- 3 – Emergency Key
- 4 – Lock
- 5 – Remote Start (If Equipped)
- 6 – Panic



Figure 2 - Keyless Ignition Key Fob

- 1 — All Doors Unlock
- 2 — Emergency Key
- 3 — Lock
- 4 — Remote Start (If Equipped)
- 5 — Panic

In case the ignition switch does not change with the push of a button, the key fob may have a low or fully depleted battery. A low key fob battery can be verified by referring to the instrument cluster display, which will display directions to follow → page 269.

To Lock/Unlock The Doors

To lock all of the doors, push and release the lock button once. Push and release the front unlock button on key fob once to unlock only the front doors (figure 1) or push and release the unlock button on key fob once to unlock all doors (figure 2). Push and release the cargo unlock button on key fob once to unlock the cargo area (rear lateral sliding doors and rear door). The doors can also be locked and unlocked manually by using the mechanical key.

When the doors are unlocked, the turn signals will flash. When the doors are locked, the turn signals will flash and the horn will chirp (if equipped and activated through the Uconnect Settings → page 136). If a door is open when the lock button is pushed, the turn signal lights will flash at an increased rate to indicate that a door is still open.

Key Left Vehicle Feature

If a valid key fob is no longer detected inside the vehicle while the vehicle's ignition system is in the ON/RUN or START position, the message "Key Fob Has Left The Vehicle" will be shown in the instrument cluster display along with an interior chime. An exterior audible and visual alert will also be activated to warn the driver.

The vehicle's horn will rapidly chirp three times along with a single flash of the vehicle's exterior lights.

NOTE:

- The doors have to be open and then closed in order for the vehicle to detect a key fob. The Key Left Vehicle feature will activate when the first door is closed and no key fob is detected in the vehicle. If the warning has been activated, and the other doors are closed, no other warning will be issued.
- These alerts will not be activated in situations where the vehicle's engine is left running with the key fob inside, or the key fob's wireless signals are blocked.

Replacing The Battery In The Key Fob

The replacement battery is one CR2032 battery.

NOTE:

- Customers are recommended to use a battery obtained from Mopar®. Aftermarket coin battery dimensions may not meet the original OEM coin battery dimensions.
 - Perchlorate Material — special handling may apply. See www.dtsc.ca.gov/hazardouswaste/perchlorate for further information.
 - Do not touch the battery terminals that are on the back housing or the printed circuit board.
1. Remove the emergency key (2) by sliding the emergency key release (1) on the back of the key fob and pulling the emergency key out with your other hand.



Emergency Key Removal

- 1 — Emergency Key Release Button
- 2 — Emergency Key

- Separate the key fob halves using a flat-blade screwdriver or a coin, and gently pry the two halves of the key fob apart. Make sure not to damage the seal during removal.



Separating Case With A Coin



Key Fob Battery Replacement

- Remove the back cover to access and replace the battery. When replacing the battery, match the (+) sign on the battery to the (+) sign on the inside of the battery clip, located on the back cover. Avoid

touching the new battery with your fingers. Skin oils may cause battery deterioration. If you touch a battery, clean it with rubbing alcohol.

- To assemble the key fob case, snap the two halves together.

WARNING!

- The integrated key fob contains a coin cell battery. Do not ingest the battery; there is a chemical burn hazard. If the coin cell battery is swallowed, it can cause severe internal burns in just two hours and can lead to death.
- If you think a battery may have been swallowed or placed inside any part of the body, seek immediate medical attention.
- Keep new and used batteries away from children. If the battery compartment does not close securely, stop using the product and keep it away from children.

Programming And Requesting Additional Key Fobs

Programming the key fob may be performed by an authorized dealer.

NOTE:

- Once a key fob is programmed to a vehicle, it cannot be repurposed and reprogrammed to another vehicle.
- Only key fobs that are programmed to the vehicle electronics can be used to start and operate the vehicle.

WARNING!

- Always remove the key fobs from the vehicle and lock all doors when leaving the vehicle unattended.
- For vehicles equipped with Keyless Enter 'n Go™ Ignition, always remember to place the ignition in the OFF position when exiting the vehicle.

Duplication of key fobs may be performed at an authorized dealer. This procedure consists of programming a blank key fob to the vehicle electronics. A blank key fob is one that has never been programmed.

NOTE:

- When having the Sentry Key Immobilizer system serviced, bring all vehicle keys with you to an authorized dealer.
- Keys must be ordered to the correct key cut to match the vehicle locks.
- It is not mandatory to replace the key fob if a new emergency key is needed, and vice versa.

SENTRY KEY

The Sentry Key Immobilizer system prevents unauthorized vehicle operation by disabling the engine. The system does not need to be armed or activated. Operation is automatic, regardless of whether the vehicle is locked or unlocked.

The system uses a key fob, keyless push button ignition and a Radio Frequency (RF) receiver to prevent unauthorized vehicle operation. Therefore, only key fobs that

are programmed to the vehicle can be used to start and operate the vehicle. The system will shut the engine off in two seconds if an invalid key fob is used to start the engine.

After placing the ignition switch in the ON/RUN position, the Vehicle Security Light will turn on for three seconds for a bulb check. If the light remains on after the bulb check, it indicates that there is a problem with the electronics. In addition, if the light begins to flash after the bulb check, it indicates that someone used an invalid key fob to start the engine. Either of these conditions will result in the engine being shut off after two seconds.

If the Vehicle Security Light turns on during normal vehicle operation (vehicle running for longer than 10 seconds), it indicates that there is a fault in the electronics. Should this occur, have the vehicle serviced as soon as possible by an authorized dealer.

CAUTION!

The Sentry Key Immobilizer system is not compatible with some aftermarket Remote Start systems. Use of these systems may result in vehicle starting problems and loss of security protection.

All of the key fobs provided with your new vehicle have been programmed to the vehicle electronics
 ➔ page 269.

NOTE:

A key fob that has not been programmed is also considered an invalid key.

IGNITION SWITCH

KEYLESS ENTER 'N GO™ IGNITION

To activate the ignition switch the key fob must be inside the passenger compartment within the first row of seats.

The START/STOP ignition button has three operating modes: OFF, ON/RUN, and START.



START/STOP Ignition Button

The push button ignition can be placed in the following modes:

OFF

- The engine is stopped
- Some electrical devices (e.g. power locks, alarm, etc.) are still available

ON/RUN

- Driving position
- All electrical devices are available (e.g. climate controls, heated seats, etc.)

START

- The engine will start (when foot is on the brake)

NOTE:

If the ignition switch does not change the mode by pushing the button, the key fob may have a low or depleted battery. In this situation, a backup method can be used to operate the ignition switch. Put the nose side (side opposite of the mechanical key) of the key fob against the START/STOP ignition button and push to operate the ignition switch.

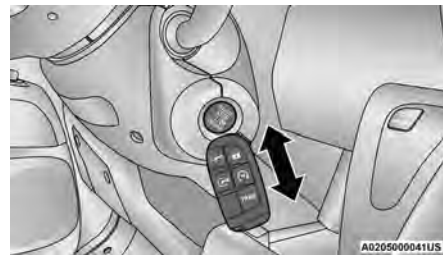

Backup Starting Method

WARNING!

- When exiting the vehicle, always remove the key fob from the vehicle and lock your vehicle.
- Never leave children alone in a vehicle, or with access to an unlocked vehicle.
- Allowing children to be in a vehicle unattended is dangerous for a number of reasons. A child or others could be seriously or fatally injured. Children should be warned not to touch the parking brake, brake pedal or the gear selector.

(Continued)

WARNING!

- Do not leave the key fob in or near the vehicle, or in a location accessible to children, and do not leave the Keyless Enter 'n Go™ Ignition in the ON/RUN position. A child could operate power windows, other controls, or move the vehicle.
- Do not leave children or animals inside parked vehicles in hot weather. Interior heat buildup may cause serious injury or death.

CAUTION!

An unlocked vehicle is an invitation for thieves. Always remove key fob from the vehicle and lock all doors when leaving the vehicle unattended.

NOTE:

- The key fob may not be detected by the vehicle Keyless Enter 'n Go™ system if it is located next to a mobile phone, laptop or other electronic device; these devices may block the key fob's wireless signal and prevent the Keyless Enter 'n Go™ system from starting the vehicle.
- For more information on normal engine starting, see [page 87](#).
- When opening the driver's door and the ignition is in the ON/RUN position (engine not running), a chime will sound to remind you to place the ignition in the OFF position. In addition to the chime, the message "Vehicle ON" will display in the cluster.

- The ignition will automatically switch to the OFF position if the following vehicle conditions last for 30 minutes: ignition placed in ON/RUN position, gear is in PARK and engine is off.

REMOTE START — IF EQUIPPED

This system uses the key fob to start the engine conveniently from outside the vehicle while still maintaining security. The system has a range of approximately 328 ft (100 m).

Remote Start is used to defrost windows in cold weather, and to reach a comfortable climate in all ambient conditions before the driver enters the vehicle.

NOTE:

Obstructions between the vehicle and the key fob may reduce this range [↔ page 269](#).

WARNING!

- Do not start or run an engine in a closed garage or confined area. Exhaust gas contains carbon monoxide which is odorless and colorless. Carbon monoxide is poisonous and can cause serious injury or death when inhaled.
- Keep key fobs away from children. Operation of the Remote Start system, windows, door locks or other controls could cause serious injury or death.

HOW TO USE REMOTE START

Push and release the Remote Start button on the key fob twice within five seconds. The vehicle doors will lock, the parking lights will flash, and the horn will chirp twice (if programmed). Then, the engine will start, and the vehicle will remain in the Remote Start mode for a 15 minute cycle.

Pushing the Remote Start button a third time shuts the engine off.

NOTE:

- With Remote Start, the engine will only run for 15 minutes.
- Remote Start can only be used twice.
- If an engine fault is present or fuel level is low, the vehicle will not start.
- The parking lights will turn on and remain on during Remote Start mode.
- For security, power window is disabled when the vehicle is in the Remote Start mode.
- The ignition must be placed in the ON/RUN position before the Remote Start sequence can be repeated for a third cycle.

All of the following conditions must be met before the engine will Remote Start:

- Gear selector in PARK
- Doors closed
- Hood closed
- Rear cargo doors closed
- Hazard switch off
- Brake switch inactive (brake pedal not pressed)
- Battery at an acceptable charge level

- Panic button not pushed
- Fuel meets minimum requirement
- System not disabled from previous Remote Start event
- Vehicle Security system not active
- Malfunction Indicator Light (MIL) is not illuminated
- Ignition in OFF position

WARNING!

- Do not start or run an engine in a closed garage or confined area. Exhaust gas contains carbon monoxide which is odorless and colorless. Carbon monoxide is poisonous and can cause serious injury or death when inhaled.
- Keep key fobs away from children. Operation of the Remote Start system, windows, door locks or other controls could cause serious injury or death.

TO EXIT REMOTE START MODE

To drive the vehicle after starting the Remote Start system, push and release the START/STOP ignition button while pressing the brake pedal prior to the end of the 15 minute cycle.

The Remote Start system will turn the engine off if the Remote Start button on the key fob is pushed again, or if the engine is allowed to run for the entire 15 minute cycle. Once the ignition is placed in the ON/RUN position, the climate controls will resume the previously set operations (temperature, blower control, etc.).

NOTE:

To avoid unintentional shutdowns, the system will disable for two seconds after receiving a valid Remote Start request.

For vehicles equipped with the Keyless Enter 'n Go™ — Passive Entry feature, the message “Remote Start Active — Push Start Button” will display in the instrument cluster display until you push the START/STOP ignition button.

REMOTE START DEFROST MODE ACTIVATION — IF EQUIPPED

When Remote Start is active, and the outside ambient temperature is 40°F (4.5°C) or below, the system will automatically activate front defrost for 15 minutes or less. The timing is dependent on the ambient temperature. Once the timer expires, the system will automatically adjust the settings depending on ambient conditions. See “Remote Start Comfort Systems — If Equipped” in the next section for detailed operation.

REMOTE START COMFORT SYSTEMS — IF EQUIPPED

When Remote Start is activated, the front and rear defroster will automatically turn on in cold weather conditions. The heated steering wheel and driver heated seat feature will turn on if programmed in the Comfort menu screen within Uconnect Settings ⇄ page 136. In warm weather, the driver vented seat feature will automatically turn on when Remote Start is activated, if programmed in the Comfort menu screen. The vehicle will adjust the climate control settings depending on the outside ambient temperature.

NOTE:

If the vehicle is equipped with a rear climate system, it will remain off to allow for optimal front row performance.

Manual Temperature Control (MTC) — If Equipped

- In ambient temperatures of 40°F (4.5°C) or below, the climate settings will default to maximum heat, with fresh air entering the cabin. If the front defrost timer expires, the vehicle will enter Mix mode.
- In ambient temperatures from 40°F (4.5°C) to 78°F (26°C), the climate settings will be based on the last settings selected by the driver.
- In ambient temperatures of 78°F (26°C) or above, the climate settings will default to MAX A/C, Bi-Level mode, with Recirculation on.

For more information on MTC, and climate control settings, see ⇄ page 54.

NOTE:

These features will stay on through the duration of Remote Start, or until the ignition is placed in the ON/RUN position. The climate control settings will change, and exit the automatic defaults, if manually adjusted by the driver while the vehicle is in Remote Start mode. This includes turning the climate controls off using the OFF button.

REMOTE START WINDSHIELD WIPER DE-ICER ACTIVATION — IF EQUIPPED

When Remote Start is active and the outside ambient temperature is less than 33°F (0.6°C), the Windshield Wiper De-Icer will activate. Exiting Remote Start will resume its previous operation. If the Windshield Wiper De-Icer was active, the timer and operation will continue.

REMOTE START ABORT MESSAGE

One of the following messages will display in the instrument cluster display if the vehicle fails to remote start or exits Remote Start prematurely:

- Remote Start Canceled — Door Open
- Remote Start Canceled — Hood Open
- Remote Start Canceled — Fuel Low
- Remote Start Canceled — Rear/Side Cargo Door Open
- Remote Start Canceled — Time Expired
- Remote Start Canceled — System Fault
- Remote Start Disabled — Start Vehicle to Reset

The instrument cluster display message stays active until the ignition is placed in the ON/RUN position.

REMOTE START SYSTEM (BEV) — IF EQUIPPED

NOTE:

Remote Start on BEV while plugged in may not always start the engine.



This system uses the key fob to start the vehicle conveniently from outside the vehicle while still maintaining security. The system has a range of 328 ft (100 m).

The Remote Start system also activates the Climate Control system and vented seats (if equipped) in temperatures above 80°F (26.7°C). It activates the optional heated seats, optional heated steering wheel, optional heated mirrors and rear defroster in temperatures below 40°F (4.4°C).

NOTE:

Obstructions between the vehicle and key fob may reduce this range.

HOW TO USE REMOTE START

Push and release the Remote Start button on the key fob twice within five seconds. The vehicle doors will lock, the parking lights will flash, and the horn will chirp twice (if programmed). Then, the vehicle will start, and remain in the Remote Start mode for a 15 minute cycle.

Pushing the Remote Start button a third time shuts the vehicle off.

NOTE:

- With Remote Start, the vehicle will only run for 15 minutes.

- Remote Start can only be used twice.
- If an engine fault is present or fuel level is low, the vehicle will start and then shut down in 10 seconds.
- The parking lights will turn on and remain on during Remote Start mode.
- For security, power window and power sunroof (if equipped) operations are disabled when the vehicle is in Remote Start mode.
- The ignition must be placed in the ON/RUN position before the Remote Start sequence can be repeated for a third cycle.

All of the following conditions must be met before the vehicle will remote start:

- Gear selector in PARK
- Doors closed
- Hood closed
- Liftgate closed
- Hazard switch off
- Brake switch inactive (brake pedal not pressed)
- 12 Volt battery at an acceptable charge level
- Key fob Panic button not pushed
- System not disabled from previous Remote Start event
- Vehicle Security system indicator flashing
- Ignition in the OFF position
- Fuel level meets minimum requirement
- Malfunction Indicator Light (MIL) is off while vehicle is in propulsion system active
- Electronic Throttle Control (ETC) Warning Light is not illuminated
- Electric Vehicle Service Light is not illuminated

WARNING!

- Do not start or run an engine in a closed garage or confined area. Exhaust gas contains carbon monoxide which is odorless and colorless. Carbon monoxide is poisonous and can cause serious injury or death when inhaled.
- Keep key fobs away from children. Operation of the Remote Start system, windows, door locks or other controls could cause serious injury or death.

TO EXIT REMOTE START MODE

Push and release the Remote Start button one time or allow the Remote Start cycle to complete the entire 15 minute cycle.

In addition, the ignition can be cycled to the RUN (Pre-Propulsion System Active) position by pressing the ignition button with the key fob in the vehicle, and then pushing the ignition button one more time to place the ignition in the OFF position.

NOTE:

To avoid unintentional shutdowns, the system will temporarily disable for two seconds after receiving a valid Remote Start request.

SCHEDULED CABIN CONDITIONING (SCC)

This feature allows the driver to pre-condition (warm up or cool down) the passenger cabin based on a planned departure time. The target temperature is preset to the same values used by the Remote Start feature. Unlike Remote Start, the driver does not need to initiate the cabin conditioning by pushing the Remote Start button,

instead, a programmed departure time will be used. Also, all scheduled cabin conditioning will be powered by the vehicle's high voltage battery working in conjunction with any EVSE connected to the vehicle. Unlike Remote Start, in SCC the vehicle's gas engine will not start to provide power or heat for cabin conditioning.

In order to conserve the vehicle's high voltage battery power, the driver can choose between allowing the battery to be drained of power down to <1%, or to stop the SCC when the high voltage battery has been depleted to 25% State Of Charge (SOC). The battery percentages are displayed in the instrument cluster display.

A maximum of two independent schedule event timers are available for use by the SCC feature and Scheduled Charging feature for charging the high voltage battery. The timers may be used in any combination for SCC and Scheduled Charging, but only two total timers are available.

The SCC event times are used to wake up the vehicle so that the Climate Control system can condition the passenger cabin prior to the scheduled departure time. Based on vehicle operating conditions, ambient temperature, and the next programmed departure time, the vehicle will determine when to begin cabin conditioning. Cabin conditioning can begin up to 30 minutes prior to the scheduled departure time, provided the stated high voltage battery conditions are met.

The SCC will continue for a maximum of 15 minutes after the scheduled departure time.

Once a scheduled event has been created, it can be applied to one or more days of the week. The scheduled event can also be set to occur only during the current week, or repeat every week until the feature is turned off or the event is changed.

All of the following conditions must be met before the vehicle will initiate a scheduled SCC event:

- Gear selector in PARK
- Doors Closed
- Hood Closed
- Rear Compartment Closed
- Hazard switch off
- 12 Volt battery at an acceptable charge level
- Key fob not located inside the vehicle
- Ignition in the OFF position
- Remote Start has not been activated

Scheduling An SCC Event:

1. Select the Electric Vehicle App on the touchscreen.
2. Select "Schedules".

**Schedules Screen**

3. Choose "Climate Schedules".
4. Select one of two Climate Schedules by pressing the appropriate arrow on the right side of the touchscreen.

5. Select if SCC should stop when the high voltage battery drops to 25% or lower.
6. Set the Manual Climate Schedule Departure Time: Hours, Minutes, and AM/PM or set the Auto Climate Schedule Departure Time: Hours, Minutes, AM/PM, and Temperature.



Set Manual Climate Schedule



Set Auto Climate Schedule

7. Select the days that this SCC event will occur. The "Repeat" indicator illuminates to indicate that SCC will occur every week on the selected day(s), at the selected time.

If you uncheck the "Repeat" option, all the days of the week will be grayed out and the vehicle will perform only one SCC event, which will occur at the next available time that matches the SCC event time (regardless of what day it was originally set to occur before "Repeat" was unchecked).

8. To schedule another SCC event, press the X and repeat these steps.

VEHICLE SECURITY SYSTEM — IF EQUIPPED

The Vehicle Security system monitors the vehicle doors and ignition for unauthorized operation. When the Vehicle Security system is activated, interior switches for door locks are disabled. The system provides both audible and visible signals. For the first three minutes, the horn will sound, and the turn signal lights will flash. For an additional 15 minutes, only the turn signal lights will flash.

TO ARM THE SYSTEM

Follow these steps to arm the Vehicle Security system:

1. Make sure the vehicle's ignition is placed in the OFF position.
2. If any doors are open, close them.

3. Perform one of the following methods to lock the vehicle:
 - Push the lock button on the exterior Passive Entry door handle with a valid key fob available in the same exterior zone ↪ page 36.
 - Push the lock button on the key fob.

When the Vehicle Security system is armed, the Vehicle Security Light (on the lock/unlock button on the instrument panel) will begin to flash every three seconds until it is disarmed.

NOTE:

If a door or the hood is not properly closed, the system will not be armed.

TO DISARM THE SYSTEM

The Vehicle Security system can be disarmed using any of the following methods:

- Push the unlock button on the key fob.
- Push the Passive Entry button next to the door handle to unlock the door ↪ page 36.
- Cycle the ignition out of the OFF position to disarm the system.

The Vehicle Security system is designed to protect your vehicle. However, you can create conditions where the system will give you a false alarm. If one of the previously described arming sequences has occurred, the Vehicle Security system will arm regardless of whether you are in the vehicle or not. If you remain in the vehicle and open a door, the alarm will sound. If this occurs, disarm the Vehicle Security system.

REARMING OF THE SYSTEM

If the system has not been disabled, the Vehicle Security system will rearm itself after the 15 additional minutes of the turn signals flashing. If the condition which initiated the alarm is still present, the system will ignore that condition and monitor the remaining doors and ignition.

SECURITY SYSTEM MANUAL OVERRIDE

The Vehicle Security system will not arm if you lock the doors using the manual door lock.

DOORS

POWER DOOR LOCKS

The power lock/unlock button has an LED that indicates whether the doors are locked or unlocked.

Push the lock button on the instrument panel. The indicator light will illuminate to show the doors are locked.

Push the lock button on the instrument panel a second time to unlock the doors.

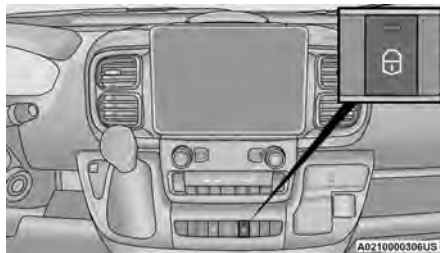

Lock Button On Instrument Panel

- **LED ON:** Doors locked. Push the central lock/unlock button once to centrally unlock the front doors. The LED will switch off.
- **LED OFF:** Doors unlocked. Push the central lock/unlock button again to centrally lock the front doors. The doors will be locked only if all the doors are properly closed.

To unlock the front doors, pull the inside door handle to the detent.

The cargo area power door lock switch is located on the driver door trim panel. Use this switch to lock or unlock the cargo area doors and all front doors.

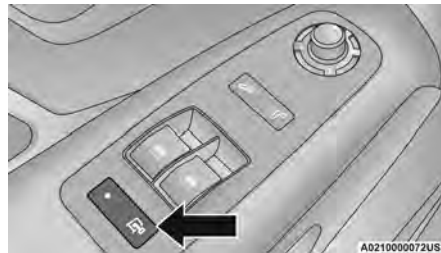

Cargo Area Power Door Lock Switch

The cargo area lock/unlock button has an LED that indicates whether the rear doors are locked or unlocked.

Once the doors have been locked with the key fob, it will no longer be possible to unlock them by pushing the central lock/unlock button.

WARNING!

- Do not leave children or animals inside parked vehicles in hot weather. Interior heat buildup may cause serious injury or death.
- For personal security and safety in the event of a collision, lock the vehicle doors as you drive as well as when you park and leave the vehicle.
- Before exiting a vehicle, always shift the transmission into PARK, apply the parking brake, turn the vehicle OFF, remove the key fobs from vehicle, and lock all doors. and lock your vehicle.

(Continued)

WARNING!

- Never leave children alone in a vehicle, or with access to an unlocked vehicle. Allowing children to be in a vehicle unattended is dangerous for a number of reasons. A child or others could be seriously or fatally injured. Children should be warned not to touch the parking brake, brake pedal or the gear selector.
- Do not leave the key fob in or near the vehicle, or in a location accessible to children, and do not leave the Keyless Enter 'n Go™ Ignition in the ON/RUN position. A child could operate power windows, other controls, or move the vehicle.
- Driving with the rear doors open can allow poisonous exhaust gases into your vehicle. You and your passengers could be injured by these fumes. Keep the rear doors closed when you are operating the vehicle.
- If you are required to drive with the rear doors open, make sure that all windows are closed and the climate control blower control is set to a high speed. DO NOT use the recirculation mode.

CAUTION!

An unlocked vehicle is an invitation for thieves. Always remove the key fob from the vehicle and lock all of the doors when leaving the vehicle unattended.

**AUTO UNLOCK DOORS —
IF EQUIPPED**

This feature unlocks all front doors when one front door is opened.

NOTE:

If the rear or side door is open, only the rear or side door is unlocked. The Auto Unlock Doors feature can be enabled within the Uconnect settings.

**KEYLESS ENTER 'N GO™ —
PASSIVE ENTRY**

The Passive Entry system is an enhancement to the vehicle's key fob and a feature of Keyless Enter 'n Go™ — Passive Entry. This feature allows you to lock and unlock the vehicle's door(s) without having to push the key fob lock or unlock buttons.

NOTE:

- Passive Entry may be programmed on or off within Uconnect Settings ➔ page 136.
- The key fob may not be detected by the vehicle Passive Entry system if it is located next to a mobile phone, laptop, or other electronic device; these devices may block the key fob's wireless signal and prevent the Passive Entry system from locking/unlocking the vehicle.
- Passive Entry Unlock initiates illuminated approach (low beams, license plate lamp, position lamps) for whichever duration is set between 0, 30, 60 or 90 seconds. Passive Entry Unlock also initiates two flashes of the turn signals.

- If the vehicle is unlocked by Passive Entry and no door is opened within 60 seconds, the vehicle will relock and (if equipped) will arm the Vehicle Security system.

To Unlock From The Driver, Passenger or Rear Door

With a valid Passive Entry key fob within 5 ft (1.5 m) of the door handle, push the Passive Entry button next to the handle to unlock the vehicle.

- Unlock the front doors only if the Uconnect setting is set to "Approach" and you press the button located next to the front handle.
- Unlock the cargo area doors only if the Uconnect setting is set to "Approach" and you press the button located next to the rear handle.
- The Passive Entry feature will be disabled if the Uconnect setting is set to "Off".

NOTE:

- Either the cargo area and cabin compartment or all doors will unlock when you press Passive Entry button, depending on the selected setting in the Uconnect system ➔ page 136.

To Lock The Vehicle's Doors

With one of the vehicle's Passive Entry key fobs within 5 ft (1.5 m) of either front door handle, pushing the Passive Entry lock button will lock the vehicle.

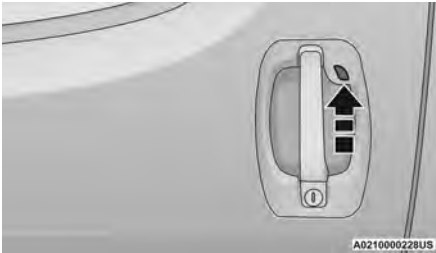

Push The Door Handle Button To Lock

NOTE:

- After pushing the door handle button, you must wait two seconds before you can lock or unlock the doors, using either Passive Entry door handle. This is done to allow you to check if the vehicle is locked by pulling the door handle without the vehicle unlocking.
- The Passive Entry system will not operate if the key fob battery is depleted.
 - When the key fob battery is low, the instrument cluster will display a message indicating that the key fob battery is low → page 269.

POCKET DOOR (BEV MODELS) — IF EQUIPPED

Push the lock button on the instrument panel. The indicator light will illuminate to show the doors are locked.

Push the lock button on the instrument panel a second time to unlock the doors.

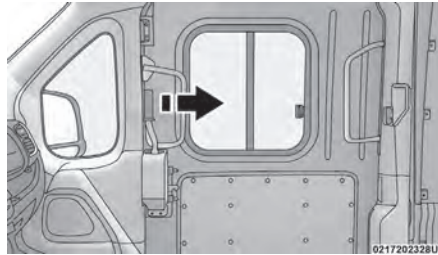

Interior Pocket Door Handle

To open from the inside, pull the inside door handle towards the rear of the vehicle.

ROLL-UP DOOR — IF EQUIPPED

Unlocking the Rear Roll-Up Door

Unlock the rear roll-up door by pressing the unlock button the key fob.

Opening From The Outside

To open from the outside, pull up on the exterior roll-up door handle. This will release the door from the side stop latches.

Lift the door about halfway, then push from the bottom of the door upwards to the fully open position.

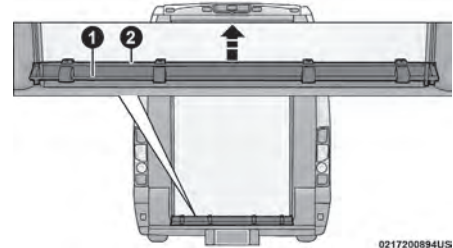

Exterior Roll-up Door Handle

- 1 — Exterior Roll-Up Door Handle
- 2 — Exterior Roll-Up Door Flange Handle

Opening From The Inside

To open from the inside, push down on the latch release mechanism with either your hand or your foot. Pull up on the interior roll-up door flange or pull up using the door strap.

Lift the door about halfway, then push from the bottom of the door upwards to the fully open position.

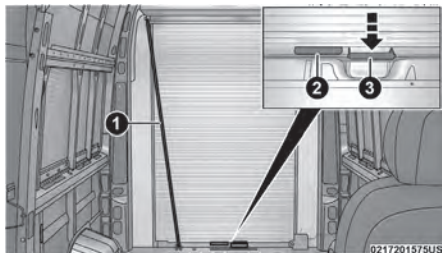
**Interior Roll-up Door Operation**

- 1 — Roll-Up Door Strap 2 — Interior Roll-Up Door Flange Handle
3 — Interior Latch Release Mechanism

Closing The Roll-Up Door

For exterior or interior closing, use the strap to pull the door downwards to the bottom position. Then, push the handle flange down until the locking mechanism engages the side latches.

Locking The Roll-Up Door

To lock the roll-up door, press the lock button on the key fob.

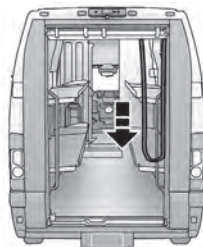
**Roll-Up Door Strap**

0217200897US

Emergency Release Latch

In the event of a power failure, the roll-up door can be released by pulling up on the Emergency Release code. The cord is located on top of the interior side latch mechanism.

**Emergency Release Latch Location**

0217200896US

STEERING WHEEL**TELESCOPING STEERING COLUMN**

This feature allows you to lengthen or shorten the steering column. The telescoping control handle is located below the steering wheel at the end of the steering column.

**Telescoping Control Handle**

A0213000058US

To unlock the steering column, pull the control handle up. To lengthen or shorten the steering wheel outward or push it inward as desired. To lock the steering column in position, push the control handle down until fully engaged.

WARNING!

Do not adjust the steering column while driving. Adjusting the steering column while driving or driving with the steering column unlocked, could cause the driver to lose control of the vehicle. Failure to follow this warning may result in serious injury or death.

HEATED STEERING WHEEL — IF EQUIPPED

The steering wheel contains a heating element that helps warm your hands in cold weather. The heated steering wheel has only one temperature setting. Once the heated steering wheel has been turned on, it will stay on until the operator turns it off. The heated steering wheel may not turn on when it is already warm.

The heated steering wheel button is located within the Uconnect system and, if equipped, on the instrument panel below the radio. You can access the button through the Climate or Controls menu of the touchscreen.

- Press the heated steering wheel button once to turn the heating element on.
- Press the heated steering wheel button a second time to turn the heating element off.

NOTE:

The engine must be running for the heated steering wheel to operate.

For information on use with the Remote Start system, see ↪ page 31.

WARNING!

- Persons who are unable to feel pain to the skin because of advanced age, chronic illness, diabetes, spinal cord injury, medication, alcohol use, exhaustion, or other physical conditions must exercise care when using the steering wheel heater. It may cause burns even at low temperatures, especially if used for long periods.

(Continued)

WARNING!

- Do not place anything on the steering wheel that insulates against heat, such as a blanket or steering wheel covers of any type of material. This may cause the steering wheel heater to overheat.

SEATS

Seats are a part of the Occupant Restraint system of the vehicle.

WARNING!

- It is dangerous to ride in a cargo area, inside or outside of a vehicle. In a collision, people riding in these areas are more likely to be seriously injured or killed.
- Do not allow people to ride in any area of your vehicle that is not equipped with seats and seat belts. In a collision, people riding in these areas are more likely to be seriously injured or killed.
- Be sure everyone in your vehicle is in a seat and using a seat belt properly.

MANUAL ADJUSTMENTS

The driver and passenger seats can be adjusted forward/rearward and reclined. Front and rear height and lumbar can also be adjusted (if equipped).

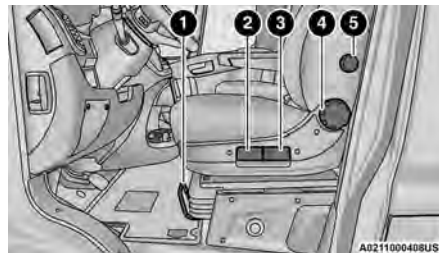

Seat Adjustment (Without Swivel Seat)

- 1 — Forward/Rearward Adjustment Bar
- 2 — Front Height Adjustment Lever (If Equipped)
- 3 — Rear Height Adjustment Lever (If Equipped)
- 4 — Recliner Knob
- 5 — Lumbar Knob (If Equipped)

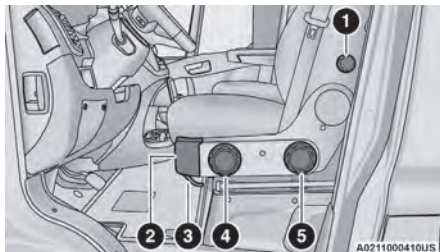

Seat Adjustment (With Swivel Seat)

- 1 — Lumbar Knob
- 2 — Swivel Seat Lever
- 3 — Forward/Rearward Adjustment Bar
- 4 — Front Height Adjustment Knob
- 5 — Rear Height Adjustment Knob

WARNING!

- Adjusting a seat while driving may be dangerous. Moving a seat while driving could result in loss of control which could cause a collision and serious injury or death.
- Seats should be adjusted before fastening the seat belts and while the vehicle is parked. Serious injury or death could result from a poorly adjusted seat belt.

Forward And Rearward Adjustment

The adjustment bar is at the front of the seat, near the floor. Pull the bar upward to move the seat forward or rearward. Release the bar once the seat is in the desired position. Then, using body pressure, move forward and rearward on the seat to be sure that the seat adjusters have latched.

Height Adjustment — If Equipped

Without Swivel Seat

The height adjustment levers are located on the center outboard side of the seat. Lift up on the front lever to adjust the front of the seat, or lift up on the rear lever to adjust the rear of the seat.

- To raise the front or rear of the seat, lift the appropriate lever while none or minimal weight is applied to the seat.
- To lower the front or rear of the seat, lift the appropriate lever while seated or applying weight to the seat.

With Swivel Seat

The height adjustment knobs are located on the center outboard side of the seat. Rotate the front knob to adjust the front of the seat up or down. Rotate the rear knob to adjust the rear of the seat up or down.

Recliner Adjustment

Without Swivel Seat

The recliner knob is on the rear outboard side of the seat. To recline the seatback, lean back and rotate the knob rearward to position the seatback as desired. To return the seatback to its normal upright position, lean forward and rotate the knob forward until the seatback is in the upright position.

With Swivel Seat

The recliner lever is located at the lower front outboard side of the seat. To recline the seatback, lean forward slightly, pull the lever outward, lean back to the desired position and release the lever. To return the seatback to its normal upright position, lean forward and pull the lever outward. Release the lever once the seatback is in the upright position.

WARNING!

- Adjusting a seat while the vehicle is moving is dangerous. The sudden movement of the seat could cause you to lose control. The seat belt might not be adjusted properly and you could be injured. Adjust the seat only while the vehicle is parked.
- Do not ride with the seatback reclined so that the shoulder belt is no longer resting against your chest. In a collision, you could slide under the seat belt and be seriously or even fatally injured. Use the recliner only when the vehicle is parked.

Lumbar Support — If Equipped

This feature allows you to increase or decrease the amount of lumbar support. The lumbar control knob is located on the rear upper outboard side of the driver's seatback. Rotate the control forward to increase and rearward to decrease the desired amount of lumbar support.

Swivel Seat — If Equipped

The swivel seat lever is located at the lower front inboard side of the seat. The seat may be turned through 180° toward the seat on the opposite side and approximately 35° toward the door. The seat may be locked in the driving position or at the 180° position. To swivel the seat, pull the swivel seat inboard lever outward, turn the seat to the desired position and release the lever.



Swivel Seat Lever

If the vehicle is equipped with interlocking swivel seats, the seats must be locked in the facing forward position while driving. If the seats are not in the correct position, a warning will appear in the instrument cluster display. If the driver or the passenger seats are not locked in the facing forward position before the first vehicle movement, shifting out of park is not allowed until the seats are both locked in the facing forward position.

When the seats are not in the right position and the first vehicle movement after ignition START is attempted, a chime and a message will appear in the instrument cluster display. Rotate and lock the swivel seats in the correct position before trying again.

If the driver or the passenger seats are not locked in the facing forward position during movement of the vehicle, a message will appear in the instrument cluster display and an intermittent chime will sound until key-off or until the swivel seats are locked in the facing forward position. Stop and move the swivel seats in the correct position before proceeding.

If a fault is present in the system and it is not possible to check the correct position of the swivel seats, a message and the generic warning light appears in the instrument cluster display to inform about the failure. In these conditions, check the status of the swivel seats and do not drive the vehicle until the swivel seats are locked in the facing forward position.

Jump Seat (BEV Models) — If Equipped

The jump seat is available for passenger use. To lower the seat, pull down on the bottom of the seat. The seat will return to stowed position once pressure is removed from seat bottom.

For seat belt operation instructions, follow steps shown in Lap/Shoulder Belt Operating Instructions

↪ page 168.

No child restraint should ever be placed in the jump seat.

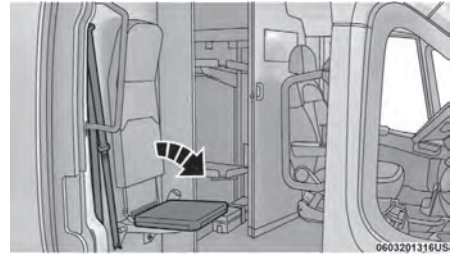

Lowering The Jump Seat

WARNING!

The jump seat is not designed to be used with a child safety seat or a booster seat.

HEATED SEATS — IF EQUIPPED



On some models, the front driver and passenger seats may be equipped with heaters in both the seat cushions and seatbacks.

The controls for the front heated seats are located on the lower outboard side of the seat.

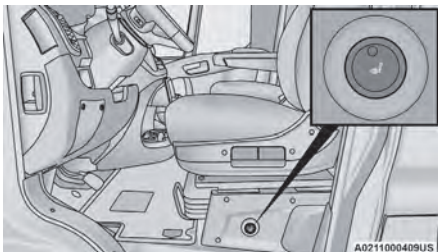

Heated Seat Switch

Push the switch once to turn on the heated seats. Push the switch a second time to shut the heating elements off.

NOTE:

Once a heat setting is selected, heat will be felt within two to five minutes.

WARNING!

- Persons who are unable to feel pain to the skin because of advanced age, chronic illness, diabetes, spinal cord injury, medication, alcohol use, exhaustion or other physical condition must exercise care when using the seat heater. It may cause burns even at low temperatures, especially if used for long periods of time.
- Do not place anything on the seat or seatback that insulates against heat, such as a blanket or cushion. This may cause the seat heater to overheat.

(Continued)

WARNING!

Sitting in a seat that has been overheated could cause serious burns due to the increased surface temperature of the seat.

FOLD DOWN TRAY — IF EQUIPPED

If your vehicle is equipped with a bench seat, the seat is equipped with a fold-down tray that can be used as a document support surface. To use the fold-down tray, grab the pull tab and lower the tray.

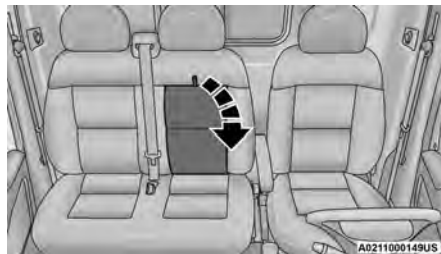

Lowering The Fold-Down Tray

The fold-down tray is equipped with two cup holders and a support surface with a paper holder clip.

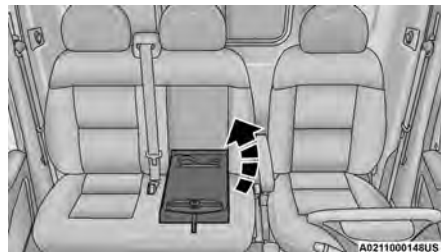

Closing The Fold-Down Tray

ADJUSTABLE ARMRESTS — IF EQUIPPED

The seat adjustable armrest can be raised and adjusted for height. Underneath the front of the armrest is the adjuster wheel which will adjust the height of the armrest up or down.

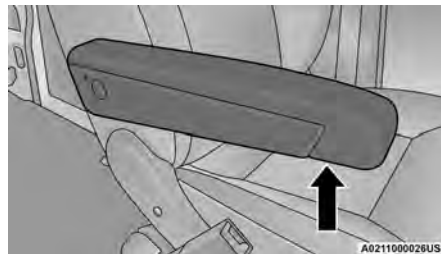

Adjuster Wheel Location

Turn the adjuster wheel to the right or left to adjust the height of the armrest up or down.

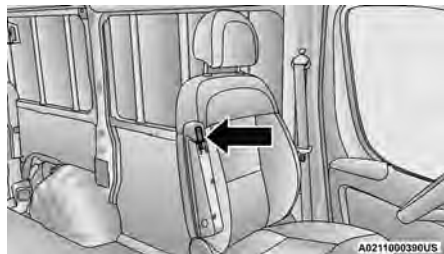

Adjuster Wheel

HEAD RESTRAINTS

Head restraints are designed to reduce the risk of injury by restricting head movement in the event of a rear impact. Head restraints should be adjusted so that the top of the head restraint is located above the top of your ear.

WARNING!

- All occupants, including the driver, should not operate a vehicle or sit in a vehicle's seat until the head restraints are placed in their proper positions in order to minimize the risk of neck injury in the event of a crash.
- Head restraints should never be adjusted while the vehicle is in motion. Driving a vehicle with the head restraints improperly adjusted or removed could cause serious injury or death in the event of a collision.

Front Head Restraint Adjustment

To raise the head restraint, pull upward on the head restraint. To lower the head restraint, push the adjustment button located on the base of the head restraint and push downward on the head restraint.

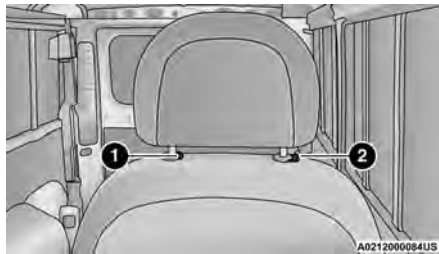

Adjustment Buttons

- 1 — Release Button
- 2 — Adjustment Button

NOTE:

Do not reposition the head restraint 180 degrees to the incorrect position in an attempt to gain additional clearance to the back of the head.

Front Head Restraint Removal

To remove the head restraint, raise it up as far as it can go. Then, push the adjustment button and the release button at the base of each post while pulling the head restraint up. To reinstall the head restraint, push the adjustment button and the release button at the base of each post and put the head restraint posts into the holes. Then, adjust it to the appropriate height.

NOTE:

Do not reposition the head restraint 180 degrees to the incorrect position in an attempt to gain additional clearance to the back of the head.

WARNING!

- A loose head restraint thrown forward in a collision or hard stop could cause serious injury or death to occupants of the vehicle. Always securely stow removed head restraints in a location outside the occupant compartment.
- ALL the head restraints MUST be reinstalled in the vehicle to properly protect the occupants. Follow the preceding reinstallation instructions prior to operating the vehicle or occupying a seat.

Rear Adjustment — If Equipped

The outboard and center head restraints are adjustable and removable. To raise the head restraint, push and hold the adjustment button, located on the base of the head restraint and pull upward on the head restraint. To lower the head restraint, push and hold the adjustment button, and push downward on the head restraint till the desired height is reached.

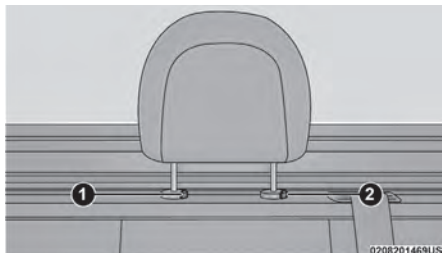

Release/Adjustment Buttons

- 1 – Release Button
2 – Adjustment Button

WARNING!

- A loose head restraint thrown forward in a collision or hard stop could cause serious injury or death to occupants of the vehicle. Always securely stow removed head restraints in a location outside the occupant compartment.
- ALL the head restraints MUST be reinstalled in the vehicle to properly protect the occupants. Follow the reinstallation instructions prior to operating the vehicle or occupying a seat.

Rear Head Restraint Removal — If Equipped

To remove the rear head restraints, push the release button and adjustment button while pulling upward on the whole assembly. To reinstall the headrest, put the head restraint posts into the holes while pushing the

release button and adjustment button. Then adjust it to the appropriate height.

NOTE:

WARNING!

- A loose head restraint thrown forward in a collision or hard stop could cause serious injury or death to occupants of the vehicle. Always securely stow removed head restraints in a location outside the occupant compartment.
- ALL the head restraints MUST be reinstalled in the vehicle to properly protect the occupants. Follow the reinstallation instructions prior to operating the vehicle or occupying a seat.

UCONNECT VOICE RECOGNITION — IF EQUIPPED

INTRODUCING VOICE RECOGNITION

Start using Uconnect Voice Recognition with these helpful quick tips. It provides the key Voice Commands and tips you need to know to control your vehicle's Voice Recognition (VR) system.

NOTE:

Voice Recognition is only available on the Uconnect 5 NAV With 10.1-inch Display.

BASIC VOICE COMMANDS



The following Basic Voice Commands can be given at any point while using your Uconnect system.

Push the VR button  on the steering wheel. After the beep, say a command. You can also say the system "Wake Up" word and then say a command:

- "Cancel" to stop a current voice session.
- "Help" to hear a list of suggested Voice Commands.
- "Repeat" to listen to the system prompts again.

Notice the visual cues that inform you of your Voice Recognition system's status.

GET STARTED

The  VR button is used to activate/deactivate your Voice Recognition system. You can also use the system's "Wake Up" word to activate voice recognition. The "Wake Up" word can be set through the Uconnect Settings  page 136.

Helpful hints for using Voice Recognition:

- Reduce background noise. Wind noise and passenger conversations are examples of noise that may impact recognition.
- Speak clearly at a normal pace and volume while facing straight ahead.
- Each time you give a Voice Command, first push the VR button, wait until after the beep, then say your Voice Command. Also, you can say the vehicle "Wake Up" word to issue a Voice Command. The available "Wake Up" words are "Hey Uconnect" and "Hey Ram".
- You can interrupt the help message or system prompts by pushing the VR button and saying a Voice Command from the current category.

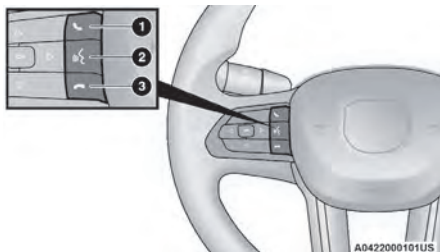

Uconnect Voice Command Buttons

- 1 – Push To Answer a Phone Call
- 2 – For Vehicles Equipped With Navigation: Push The Voice Recognition Button To Begin Radio, Media, Navigation, Climate, Start Or Answer A Phone Call, And Send Or Receive A Text
- 2 – For Vehicles Not Equipped With Navigation: Push The Phone Button To Answer An Incoming Phone Call
- 3 – Push To End A Phone Call

ADDITIONAL INFORMATION

© 2023 FCA US LLC. All rights reserved. Mopar and Uconnect are registered trademarks, and Mopar Owner Connect is a trademark of FCA US LLC. SiriusXM® and all related marks and logos are trademarks of SiriusXM® Radio Inc.

Uconnect System Support:

- US visit www.DriveUconnect.com or call 1-877-855-8400 (24 hours a day 7 days a week)
- Canada visit www.DriveUconnect.ca or call 1-800-465-2001 (English) or 1-800-387-9983 (French)

SiriusXM Guardian™ services support:

- US visit <https://www.driveuconnect.com/sirius-xm-guardian.html> or call 1-844-796-4827
 - Canada visit <https://www.driveuconnect.ca/en/sirius-xm-guardian> or call 1-877-324-9091
- ↪ page 269

MIRRORS

INSIDE REARVIEW MIRROR

Manual Mirror – If Equipped

The rearview mirror can be adjusted up, down, left, and right. The mirror should be adjusted to center on the view through the rear window.

Headlight glare can be reduced by moving the small control under the mirror to the night position (toward the rear of the vehicle). The mirror should be adjusted while set in the day position (toward the windshield).

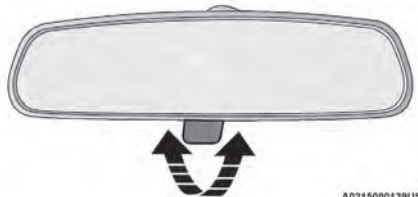

Adjusting Rearview Mirror

Digital Rearview Mirror – If Equipped

The Digital Rearview Mirror provides a high definition, wide and unobstructed view of the road behind while driving.

Position the mirror in the regular Automatic Dimming Mirror mode, then activate the Digital Rearview Mirror mode.

To activate the Digital Rearview Mirror, pull the on/off control lever on the bottom of the mirror rearward toward the driver.



Digital Rearview Mirror

- 1 – On/Off Control
- 2 – Menu Button
- 3 – Left Scroll Button
- 4 – Right Scroll Button

Push the menu button next to the on/off control to access the following mirror options:

- Brightness
- Tilt

Use the left and right buttons to scroll through menu options.

When not in use, push the on/off forward toward the windshield to return the mirror to the regular Automatic Dimming Mirror.

NOTE:

The Digital Rearview Mirror is not as effective when driving in the following conditions:

- Nighttime in low light applications
- Bad weather conditions (e.g. extreme haze, snow/slush)

If it becomes difficult to see clearly in the display, the camera may need to be cleaned. If snow, ice, mud, or any foreign substance builds up on the camera lens, clean the lens, rinse with water, and dry with a soft cloth. Do not cover the lens.

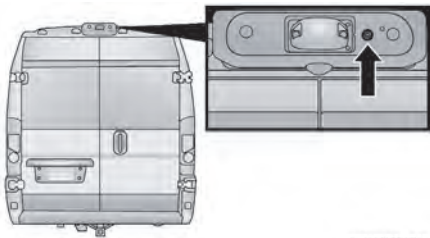

A0215000057US

Camera Location**OUTSIDE MIRRORS**

To receive maximum benefit, adjust the outside mirror(s) to center on the adjacent lane of traffic with a slight overlap of the view obtained on the inside mirror.

WARNING!

Vehicles and other objects seen in an outside convex mirror will look smaller and farther away than they really are. Relying too much on side convex mirrors could cause you to collide with another vehicle or other object. Use your inside mirror when judging the size or distance of a vehicle seen in a side convex mirror.

Outside Mirrors Folding Feature

All outside mirrors are hinged and may be folded forward or rearward to avoid damage. The hinges have three detent positions:

- Full forward position
- Full rearward position
- Normal position

OUTSIDE MIRRORS WITH TURN SIGNAL AND APPROACH LIGHTING — IF EQUIPPED

Driver and passenger outside mirrors with turn signal and approach lighting contain four LEDs, which are located in the upper outer corner of each mirror.

Three of the LEDs are turn signal indicators, which flash with the corresponding turn signal lights in the front and rear of the vehicle. Turning on the Hazard Warning flashers will also activate these LEDs.

The fourth LED supplies illuminated entry lighting, which turns on in both mirrors when you use the key fob or open any door. This LED shines outward to illuminate the front door handles. It also shines downward to illuminate the area in front of the doors.

The illuminated entry lighting fades to off after about 30 seconds or it will fade to off immediately once the ignition is placed into the ON/RUN position.

NOTE:

The approach lighting will not function when the gear selector is moved out of the PARK position.

POWER MIRRORS — IF EQUIPPED

The power mirror controls are located on the driver's side door trim panel.

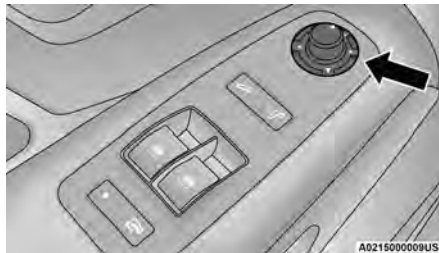

A021500009US

Power Mirror Controls

To adjust a mirror, turn the control knob toward the left upper, left lower, right upper or right lower mirror positions indicated by one of the four arrows on the switch. Tilt the control knob in the direction you want the mirror to move. When you are finished adjusting the mirror, turn the control to the center O (off) position to prevent accidentally moving a mirror.

NOTE:

- If your vehicle is equipped with additional spotter mirrors, you can adjust them when the control knob is positioned to the lower arrows.
- The vehicle must be in ON/RUN to adjust the mirrors.

POWER FOLDING OUTSIDE MIRRORS — IF EQUIPPED

The power folding mirrors can be folded rearward and unfolded into the normal driving position.

The switch for the power folding mirrors is located on the driver's door panel below the power mirror controls. Push the switch down on the right side and the mirrors will fold in, push the switch down on the left and the mirrors will return to the normal driving position.

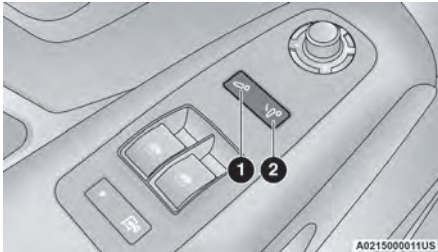

Power Folding Mirror Switch

- 1 — Power Folding Mirror (Normal Driving Position)
2 — Power Folding Mirror (Fold In Position)

The power folding mirrors are designed to be folded and unfolded using the power folding switch. If the mirrors are manually folded, the mirror head may appear loose. If the mirror head or pivot exhibits a slight amount of play, the mirror should be power folded closed, then power folded open (this may require multiple button pushes).

NOTE:

The intended use of the power folding mirrors is by pushing the buttons to fold and unfold the mirrors. Only manually fold the mirrors when necessary.

Forward Folding

Mirrors can be folded forward manually or by accidental impact. In this case it is possible to restore to position both ways, manually and electrically (as previously described).

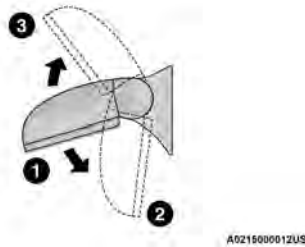

Power/Manual Folding Mirror Positions

- 1 — Normal Driving Position
2 — Fold In Position
3 — Fold Forward Position

CAUTION!

Leaving the mirror in a non-powered position, accidental impact or manual fold, may cause permanent damage to the mirror. Electrically restore the mirror to its normal position, as soon as practical.

2

HEATED MIRRORS — IF EQUIPPED



These mirrors are heated to melt frost or ice. This feature will be activated whenever you turn on the rear window defroster (if equipped) → page 54.

EXTERIOR LIGHTS

MULTIFUNCTION LEVER

The multifunction lever controls the operation of the headlights, parking lights, turn signals, headlight beam selection and the passing lights. The multifunction lever is located on the left side of the steering column.



Multifunction Lever

HEADLIGHTS

To turn on the headlights, rotate the end of the multifunction lever to the headlight position. When the headlight switch is on, the parking lights, taillights, license

plate light, clearance lights and instrument panel lights are also turned on. To turn off the headlights, rotate the end of the multifunction lever back to the O (off) position.

NOTE:

On vehicles sold in Canada, the rear parking lights, clearance lights, and Daytime Running Lights (DRLs) will turn on when the headlight switch is rotated to the O (off) position.

DAYTIME RUNNING LIGHTS (DRLs) — IF EQUIPPED

The Daytime Running Lights (DRLs) will come on when the ignition is in the ON position and the vehicle is in DRIVE or NEUTRAL.

To activate the DRLs, rotate the end of the multifunction lever to the O (off) position or the AUTO position.

NOTE:

- For vehicles sold in Canada, the Daytime Running Lights will automatically deactivate when the front fog lights are turned on.
- The low beams and side/taillights will not be on with DRLs.
- On some vehicles, the Daytime Running Lights may deactivate, or reduce intensity, on one side of the vehicle (when a turn signal is activated on that side), or on both sides of the vehicle (when the hazard warning lights are activated).

HIGH/LOW BEAM SWITCH

With the low beams activated, push the multifunction lever forward to turn on the high beams. The High Beam Indicator Light will illuminate in the instrument cluster to indicate that the high beams are on. Pull the multifunction lever back to the normal position to turn off. When the ignition is placed in the OFF position, both the high and low beams will turn off.

AUTOMATIC HIGH BEAM HEADLAMP CONTROL — IF EQUIPPED

The Automatic High Beam Headlamp Control system provides increased forward lighting at night by automating high beam control through the use of a digital camera mounted on the windshield.

This camera detects vehicle specific light and automatically switches from high beams to low beams until the approaching vehicle is out of view.

To operate, the multifunction lever must be in the AUTO position and pushed forward. An indicator light will appear in the instrument cluster display. To return to AUTO headlights, pull the multifunction lever to the normal position.

NOTE:

- The Automatic High Beam Headlamp Control can be turned on or off by selecting “ON” under “Auto Dim High Beams” within your Uconnect Settings
 page 136.

- Broken, muddy, or obstructed headlights and tail-lights of vehicles in the field of view will cause headlights to remain on longer (closer to the vehicle). Also, dirt, film, and other obstructions on the windshield or camera lens will cause the system to function improperly.
- When set to AUTO, the system automatically turns the headlights on or off based on ambient light levels.

FLASH-TO-PASS

You can signal another vehicle with your headlights by lightly pulling the multifunction lever toward you. This will cause the high beam headlights to turn on, and remain on, until the lever is released.

AUTOMATIC HEADLIGHTS — IF EQUIPPED

To turn on the automatic headlights, rotate the end of the multifunction lever to the AUTO position. To turn off the automatic headlights, rotate the end of the multifunction lever back to the O (off) position.

Use this QR code to access your digital experience.



AUTOMATIC HEADLIGHTS WITH WIPERS

If your vehicle is equipped with Automatic Headlights, it also has this customer-programmable feature. When your headlights are in the automatic mode and the engine is running, they will automatically turn on when the wiper system is on. This feature is programmable through the Uconnect system ↪ page 136.

If your vehicle is equipped with the Rain Sensing Wiper system ↪ page 53, and it is activated, the headlights will automatically turn on after the wipers complete five wipe cycles within approximately one minute. They will turn off approximately four minutes after the wipers completely stop.

NOTE:

When your headlights come on during the daytime, the instrument panel lights will automatically dim to the lower nighttime intensity.

PARKING LIGHTS

These lights can be turned on, with the ignition in the OFF position, by rotating the end of the multifunction lever from O (off) position and then to the headlight position.

HEADLIGHT DELAY

When this feature is selected, the driver can choose to have the headlights remain on for a preset period of time after the engine is turned off.

Activation

To activate the delay feature, place the ignition in the OFF position while the headlights are still on. Then, rotate the multifunction lever to the O (off) position within two minutes. The delay interval begins when the headlight switch is turned from O (off) to the low beam position. If the headlight switch is in AUTO position and headlights were on before the ignition is OFF, the delay interval begins automatically.

Deactivation

The feature is disabled by turning on the headlights, the parking lights or by placing the ignition in the RUN position. If you shut off the lights before the ignition is turned on, they will turn off in the normal manner.

Headlights with ignition in the OFF position.

With the ignition in the OFF position, the headlights can be switched on for a maximum time of 8 minutes. To turn on the headlights with the ignition in the OFF position, turn the end of the multifunction lever to the headlight position.

NOTE:

If the headlight delay function is disabled in the Uconnect Setting, when you put the ignition in the OFF position with the multifunction lever already set in the headlight ON position, the headlights remain on for 8 minutes.

FOG LIGHTS — IF EQUIPPED



The fog light switch is located on the instrument panel to the left of the steering column.

2

To activate the front fog lights, turn on the parking lights or the low beam headlights and push the fog light button. To turn off the front fog lights, push the fog light button a second time or turn off the headlight switch. An indicator light in the instrument cluster illuminates when the fog lights are turned on.

NOTE:

The fog lights will operate with the low beam headlights or parking lights on. Selecting the high beam headlights will turn off the fog lights.

If the vehicle's ignition is turned off, the fog lights will also turn off.

Cornering Lights

The cornering lights are a feature to improve visibility at night while turning the vehicle. When activated, a light incorporated in the front fog light will illuminate on the side of the vehicle the steering wheel is rotated or the turn signal indicator is on. It can be activated through the Uconnect system ↪ page 136.

TURN SIGNALS

Move the multifunction lever up or down and the arrows on each side of the instrument cluster will flash to show proper operation of the front and rear turn signals.

NOTE:

When the Daytime Running Lights are on and a turn signal is activated, the Daytime Running Lamp will turn off on the side of the vehicle in which the turn signal is flashing. The Daytime Running Lamp will turn back on when the turn signal is turned off.

If either light remains on and does not flash, or there is a very fast flash rate, check for a defective outside light bulb.

LANE CHANGE ASSIST

Lightly push the multifunction lever up or down, without moving beyond the detent, and the turn signal will flash five times then automatically turn off.

BATTERY SAVER

To protect the life of your vehicle's battery, when the ignition is OFF and any door is left ajar for 15 minutes, the interior lights will automatically turn off.

NOTE:

Battery saver mode is canceled if the ignition is placed in the ON/RUN position.

INTERIOR LIGHTS

COURTESY LIGHTS

These lights are mounted between the sun visors on the overhead console. Each light is turned on by pushing the corresponding switch.

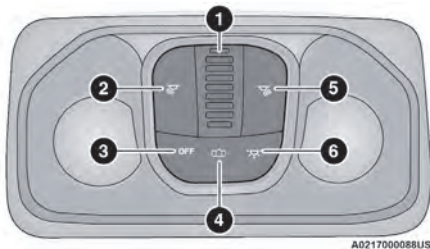

Courtesy Lights

- 1 – Ambient Light → page 52
- 2 – Driver's Map Reading Light On/Off Button
- 3 – Off/Left Position
- 4 – Center Position
- 5 – Passenger's Map Reading Light On/Off Button
- 6 – On/Right Position

Dome Lights

The interior lights can be set to three different positions (off/left position, center position, on/right position). Using the switch on the bottom of the overhead console:

- Push the switch to the on/right position from its center position and the lights are always on when a door is opened or closed.
- Push the switch to the off/left position from its center position and the lights are always off even when the doors are opened.
- Leave the switch in the center position, and the lights are turned on and off when the doors are opened or closed and will remain on for 30 seconds.

Map Lights

The switches on the left and right sides of the overhead console control the map or reading function of the lights. Push the switch on the right to turn the right light on; push again to turn off. Push the switch on the left to turn the left light on; push again to turn off.

CAUTION!

Before getting out of the vehicle be sure that the switch is in the center position or that the lights are off to avoid draining the battery.

Rear Lights

Your vehicle may be equipped with a Rear Cargo Lamp located at the upper rear cargo area above the rear doors.

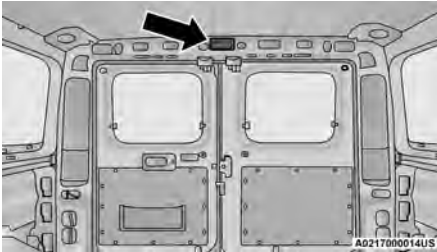

Rear Cargo Lamp Location

Your vehicle may also be equipped with a Side Cargo Lamp located at the upper rear area of the passenger side sliding door opening.



Side Cargo Lamp Location

The Rear and Side Cargo Lamps can be set to three different positions by pushing the lens to the right, left, or center positions.

- Pivot the lens to the right from its center position and the lamp is always off.

- Leave the lens in the center position, and the lamp is turned on and off when the sliding doors or rear doors are opened or closed.
- Pivot the lens to the left from its center position and the lamp is always on.

Your vehicle may also be equipped with a cargo lamp on the center of the ceiling of the cargo area.



Ceiling Cargo Lamp

Your vehicle may be equipped with one or three ceiling cargo lamps.

The ceiling cargo lamp can be set to three different positions (off position, center position, and on position).

- Push the switch to the off position from its center position and the light is always off.
- Leave the switch in the center position, and the light is turned on and off when the sliding doors or rear doors are opened or closed. The Ceiling Cargo Lamp may also be equipped with a movement sensor that will switch the light on when movement is detected.
- Push the switch to the on position from its center position and the light is always on.

NOTE:

If the ignition is placed in the OFF position, the light will stay on for about 15 minutes and then time out.

Dimmer Controls

The dimmer controls are located on the left side of the instrument panel below the instrument cluster display.



Dimmer Controls

Pushing the “+” or “-” button will increase or decrease the brightness of the instrument panel lights, cupholder lights, and footwell lights, as long as the headlights or parking lights are on.

Dimming Of The Uconnect Touchscreen

The brightness of the Uconnect touchscreen can be dimmed using the instrument panel dimmer control when the parking lights or headlights are on.

When Display Mode is set to Auto within the Uconnect system, the brightness will automatically adjust from daytime intensity to nighttime intensity (and vice versa) based on ambient light levels outside of the vehicle.

NOTE:

The brightness of the Uconnect touchscreen cannot be adjusted when the dimmer control is at the maximum setting (interior lights on), even when Display Mode is set to Auto within the Uconnect Settings.

When Display Mode is set to Manual, the brightness of the Uconnect touchscreen will adjust to the set brightness (1 - 6) when the headlights are either on or off. For more information on these Uconnect Settings, see [page 136](#).

Ambient Light

The vehicle is equipped with ambient light on the dome lamp. The ambient light will be on all the time, with the option of dimming it with the dimmer controls as long as the headlights are turned on.

Ambient LED Lighting — If Equipped

Your vehicle may be equipped with LED lighting in the front footwells and center cup holders. The brightness of the lights can be adjusted using the dimmer controls, located on the left side of the instrument panel, as long as the headlights are turned on.

ILLUMINATED ENTRY — IF EQUIPPED

The courtesy lights will turn on when you use the key fob to unlock the doors or open any door. They also turn on when unlocking or opening manually from the driver door cylinder.

The lights will fade to off after approximately 30 seconds, or they will immediately fade to off once the ignition switch is changed to the ON/RUN position from the OFF position.

The dome lights illuminate in the following ways:

- When the doors are unlocked, the dome light will illuminate for approximately 27 seconds.
- When one of the front doors is opened, the front dome light will illuminate for approximately three minutes.
- When one of the rear doors is opened, the rear dome light will illuminate for approximately three minutes.
- When the front doors are closed, the front dome light will automatically shut off after approximately 27 seconds.
- When the rear doors are closed, the rear dome light will automatically shut off after approximately 27 seconds. The timing stops once the ignition is placed in the RUN or ON position.

The dome light will turn off under any of the following conditions:

- The dome light is disabled when the ignition is placed in the RUN or ON position.
- The dome lights will turn off automatically when the doors are locked.

NOTE:

- The front courtesy overhead console and door courtesy lights will not turn off if the switch on the overhead console is in the on position.
- The illuminated entry system will not operate if the switch on the overhead console is in the OFF position.

WIPERS AND WASHERS

The windshield wiper/washer lever is located on the right side of the steering column. There are five different modes of operation for the front windshield wipers. The windshield wiper lever can be raised or lowered to access the modes.

NOTE:

The windshield wipers/washers will only operate with the ignition in the ON/RUN position.

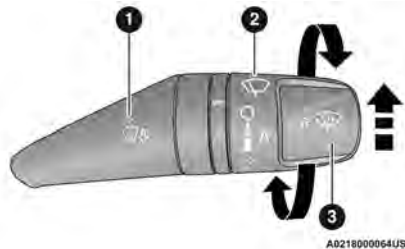
**Windshield Wiper/Washer Lever**

- 1 — Pull Back For Front Washer
- 2 — Rotate For Intermittent Settings
- 3 — Push Upward For Mist

WINDSHIELD WIPER OPERATION

Rotate the windshield wiper knob to one of the first two detent positions for intermittent settings, the third detent for low wiper operation and the fourth for high wiper operation.

Windshield Washers

To use the washer, pull the windshield wiper/washer lever toward the steering wheel to activate. The wipers will activate automatically for three cycles after the lever is released, and then resume the intermittent interval previously selected.

If the lever is pulled while in the off position, the wipers will operate for three cycles and then turn off.

WARNING!

Sudden loss of visibility through the windshield could lead to a collision. You might not see other vehicles or other obstacles. To avoid sudden icing of the windshield during freezing weather, warm the windshield with the defroster before and during windshield washer use.

Mist

Use the Mist feature when weather conditions make occasional usage of the wipers necessary. Push the lever upward to the MIST position and release for a single wiping cycle.

NOTE:

The mist feature does not activate the washer pump; therefore, no washer fluid will be sprayed on the windshield. The washer function must be used in order to spray the windshield with washer fluid.

For information on wiper care and replacement, see  page 223.

RAIN SENSING WIPERS — IF EQUIPPED

This feature senses moisture on the windshield and automatically activates the wipers. Rotate the end of the multifunction lever to one of two detent positions for intermittent settings to activate this feature.

NOTE:

If the windshield wiper lever is rotated from the O (off) position to the first intermittent setting or from the first intermittent setting to the second intermittent setting, the wipers will perform an immediate wipe cycle to clean the windshield.

The sensitivity of the system can be adjusted with the windshield wiper lever. Wiper delay position one is the least sensitive, and wiper delay position two is the most sensitive. Place the wiper switch in the O (off) position when not using the system.

NOTE:

- The Rain Sensing feature will not operate when the wiper switch is in the low or high-speed position.
- The Rain Sensing feature may not function properly when ice, or dried salt water is present on the windshield.
- Use of products containing wax or silicone may reduce Rain Sensing performance.
- The Rain Sensing feature can be turned on and off using the Uconnect system  page 136.

The Rain Sensing system has protection features for the wiper blades and arms, and will not operate under the following conditions:

- **Low Ambient Temperature** — When the ignition is first placed in the ON position, the Rain Sensing system will not operate until the wiper switch is moved, vehicle speed is greater than 3 mph (5 km/h), or the outside temperature is greater than 32°F (0°C).
- **Transmission In NEUTRAL Position** — When the ignition is ON, and the automatic transmission is in the NEUTRAL position, the Rain Sensing system will not operate until the wiper switch is moved, vehicle speed is greater than 3 mph (5 km/h), or the gear selector is moved out of the NEUTRAL position.
- **Remote Start Mode Inhibit** — On vehicles equipped with a Remote Start system, Rain Sensing wipers are not operational when the vehicle is in the Remote Start mode.

The user can activate the Rain Sensing Wipers in three ways:

- Moving the lever from the O (off) position to the intermittent positions.
- One Mist command actuation.
- The vehicle speed exceeds 3 mph (5 km/h) and the rain sensor detects the presence of rain.

NOTE:

In the event of a rain sensor failure, a dedicated telltale on the instrument cluster will appear to warn the customer (if equipped).

CLIMATE CONTROLS

The Climate Control system allows you to regulate the temperature, air flow, and direction of air circulating throughout the vehicle. The controls are located on the touchscreen and on the instrument panel below the radio.

MANUAL CLIMATE CONTROL DESCRIPTIONS AND FUNCTIONS



Uconnect 5 NAV With 10.1-Inch Display With Manual Climate Controls

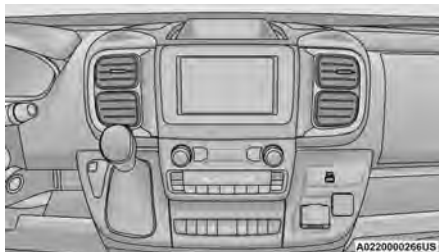

Uconnect 5 With 7-Inch Display With Manual Climate Controls

MAX A/C Button — If Equipped

MAX A/C Press and release the MAX A/C button on the touchscreen to change the current setting to the coldest output of air. The MAX A/C indicator illuminates when MAX A/C is on. Pressing the button again will cause the MAX A/C operation to exit.

A/C Button — If Equipped

A/C Push the A/C button to engage the Air Conditioning (A/C). The A/C indicator illuminates when A/C is on.

NOTE:

- For Manual Climate Controls, if the system is in Mix, Floor or Defrost mode, the A/C can be turned off, but the A/C system should remain active to prevent fogging of the windows.

- If fog or mist appears on the windshield or side glass, select Defrost mode, and increase blower speed if needed.
- If your air conditioning performance seems lower than expected, check the front of the A/C condenser (located in front of the radiator), for an accumulation of dirt or insects. Clean with a gentle water spray from the front of the radiator and through the condenser.

Recirculation Button



Press and release this button to change the system between recirculation mode and outside air mode. The Recirculation indicator and the A/C indicator illuminate when the Recirculation button is pressed. Recirculation can be used when outside conditions such as smoke, odors, dust, or high humidity are present. Recirculation can be used in all modes except for Defrost. Recirculation may be unavailable if conditions exist that could create fogging on the inside of the windshield. The A/C can be deselected manually without disturbing the mode control selection. Continuous use of the Recirculation mode may make the inside air stuffy and window fogging may occur. Extended use of this mode is not recommended. Recirculation mode may automatically adjust to optimize customer experience for warming, cooling, dehumidification, etc.

On systems with Manual Climate Controls, if equipped, the Recirculation mode is not allowed in Defrost mode to improve window clearing operation. Recirculation is disabled automatically if this mode is selected. Attempting to use Recirculation while in this mode causes the LED in the control button to blink and then turns off.

MAX Defrost Button



Push the MAX Defrost button to change the current airflow setting to Defrost mode. The indicator illuminates when this feature is on. Max defrost set maximum temperature setting for best windshield and side window defrosting and defogging. If MAX Defrost mode is turned off, the Climate Control system will return to the previous setting. Air comes from the windshield and side window demist outlets.

Rear Defrost Button — If Equipped



Push and release the Rear Defrost Control button to turn on the rear window defroster and the heated outside mirrors (if equipped). The Rear Defrost indicator illuminates when the rear window defroster is on. The rear window defroster automatically turns off after 10 minutes the first time it is activated after the first key cycle. If the key cycle is engaged again, the rear window defroster will automatically turn off 5 minutes after it is activated.

CAUTION!

Failure to follow these cautions can cause damage to the heating elements:

- Use care when washing the inside of the rear window. Do not use abrasive window cleaners on the interior surface of the window. Use a soft cloth and a mild washing solution, wiping parallel to the heating elements. Labels can be peeled off after soaking with warm water.

(Continued)

CAUTION!

- Do not use scrapers, sharp instruments, or abrasive window cleaners on the interior surface of the window.
- Keep all objects a safe distance from the window.

Temperature Control

Temperature Control regulates the temperature of the air forced through the climate system.



The temperature increases as you press the red arrow button on the faceplate.



The temperature decreases as you press the blue arrow button on the faceplate.

You can also adjust the temperature using the sliding temperature bar on the touchscreen. Slide the bar upward into the red to increase the temperature, and slide it downward into the blue to decrease the temperature.

Blower Control



Blower Control regulates the amount of air forced through the climate system. There are seven blower speeds available. The blower speed increases as you press the up arrow above the blower control symbol. The blower speed decreases as you press the down arrow below the blower control symbol.

You can also adjust the blower speed on the touchscreen by selecting a speed on the blower bar.

Mode Control



Select Mode by pressing one of the Mode buttons on the touchscreen, or the faceplate, to change the airflow distribution mode. The airflow distribution mode can be adjusted so air comes from the instrument panel outlets, floor outlets, defrost outlets and demist outlets.

NOTE:

The distribution modes on the climate control screen will also illuminate when a selection is made using the button on the instrument panel.

Panel Mode



Air comes from the outlets in the instrument panel. Each of these outlets can be individually adjusted to direct the flow of air. The air vents out of the center outlets and outboard outlets can be moved up and down or side to side to regulate airflow direction. Move the vent all the way to the left to close the vent.

Bi-Level Mode



Air comes from the instrument panel outlets and floor outlets. A slight amount of air is directed through the defrost and side window demister outlets.

NOTE:

Bi-Level mode is designed under comfort conditions to provide cooler air out of the panel outlets and warmer air from the floor outlets.

Floor Mode



Air comes from the floor outlets. A slight amount of air is directed through the defrost and side window demister outlets.

Defrost Mode



Air comes from the windshield and side window demister outlets. When the defrost button is selected, the blower level may increase.

Use Defrost mode with maximum temperature settings for best windshield and side window defrosting and defogging. When toggling the front defrost mode button, the Climate Control system will return to the previous setting.

Mix Mode



Air is directed through the floor, defrost, and side window demister outlets. This setting works best in cold or snowy conditions that require extra heat to the windshield. This setting is good for maintaining comfort while reducing moisture on the windshield.

Climate Control OFF Button



Press and release this button to turn the Climate Control ON/OFF.

ADDITIONAL REAR CLIMATE CONTROL — IF EQUIPPED

These switches, mounted on the instrument panel to the left of the steering column, activate the additional rear heating/air conditioning system.

NOTE:

These switches must be enabled for operation by the Upfitter.

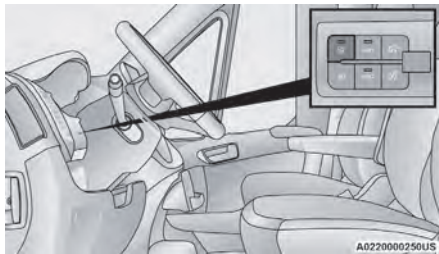

Additional Rear Climate Controls Switches

Rear Blower Control — If Equipped



Push this button to turn on the rear climate controls. An indicator light will turn on when the rear climate control is on.

OPERATING TIPS

Refer to the chart at the end of this section for suggested control settings for various weather conditions.

Summer Operation

The engine cooling system must be protected with a high-quality antifreeze coolant to provide proper corrosion protection and to protect against engine overheating. OAT coolant (conforming to MS.90032) is recommended.

Winter Operation

To ensure the best possible heater and defroster performance, make sure the engine cooling system is functioning properly and the proper amount, type, and concentration of coolant is used. Use of the Air Recirculation mode during Winter months is not recommended, because it may cause window fogging.

Vacation Storage

For information on maintaining the Climate Control system when the vehicle is being stored for an extended period of time, see [page 257](#).

Window Fogging

Vehicle windows tend to fog on the inside in mild, rainy, and/or humid weather. To clear the windows, select Defrost or Mix mode and increase the front blower speed. Do not use the Recirculation mode without A/C for long periods, as fogging may occur.







Outside Air Intake

Make sure the air intake, located directly in front of the windshield, is free of obstructions, such as leaves. Leaves collected in the air intake may reduce airflow, and if they enter the air distribution box, they could plug the water drains. In Winter months, make sure the air intake is clear of ice, slush, and snow.

Cabin Air Filter

The Climate Control system filters out dust and pollen from the air. Contact an authorized dealer to service your cabin air filter, and to have it replaced when needed.

Operating Tips Chart

WEATHER	CONTROL SETTINGS
Hot Weather And Vehicle Interior Is Very Hot	Set the mode control to  (Panel mode), A/C (A/C) on, and blower on high. Roll down the windows for a minute to flush out the hot air. Adjust the controls as needed to achieve comfort.
Warm Weather	Turn A/C (A/C) on and set the mode control to  (Panel Mode).
Cool Sunny	Operate in  (Bi-Level Mode).
Cool & Humid Conditions	Set the mode control to  (Mix Mode) and turn A/C (A/C) on to keep windows clear.
Cold Weather	Set the mode control to  (Floor Mode). If windshield fogging starts to occur, move the control to  (Mix Mode).

INTERIOR STORAGE AND EQUIPMENT

STORAGE

Glove Box Compartments

The glove box compartment is located on the passenger side of the instrument panel and features both an upper and lower storage area.

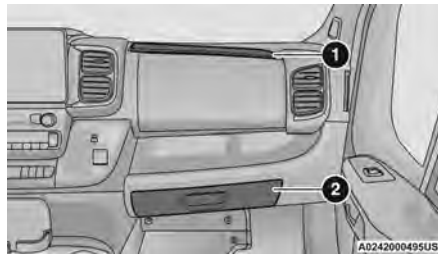

Glove Box Compartments

- 1 – Upper Glove Box Compartment
2 – Lower Glove Box Compartment

Dash Storage

The dash storage is located on the right side of the instrument panel.

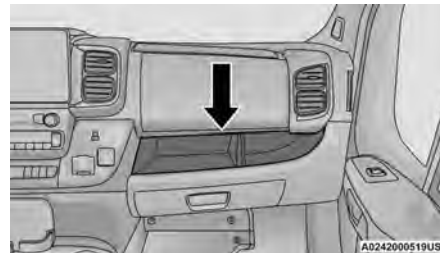

Dash Storage

Underseat Storage Tray (Driver Side Only) — If Equipped

A storage tray is located under the driver's seat. To remove the tray, lift up on the tray to withdraw it from the hooks on the support base, then slide the tray out from under the seat.

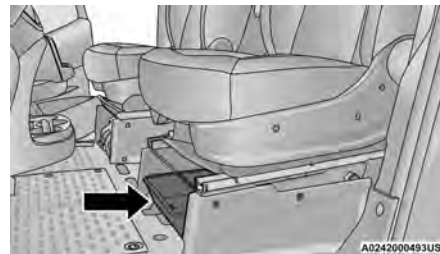

Underseat Storage Tray

USB CONTROL — IF EQUIPPED

The USB ports are located on the instrument panel to the right of the radio. This feature allows an external USB device to be plugged into the USB port.

Plugging in a smartphone device to a USB port may activate Android Auto™ or Apple CarPlay® features, if equipped. For further information, refer to “Android Auto™” or “Apple CarPlay®” in the Uconnect Radio Instruction Manual.

NOTE:

Two devices can be plugged in at the same time, and both ports will provide charging capabilities. Only one port can transfer data to the system at a time.

For example, if a device is plugged into the Type A USB port and another device is plugged into the Type C USB port, a message will appear and allow you to select which device to use.

Different scenarios are listed as follows when a non-phone device is plugged into the smaller and larger USB ports, and when a phone device is plugged into the smaller and larger USB ports:

- “A new device is now connected. Previous connection was lost.”
- “(Phone Name) now connected. Previous connection was lost.”
- “Another device is in use through the same USB port. Please disconnect the first device to use the second device.”

Plugging in a phone or another USB device may cause the connection to a previous device to be lost.

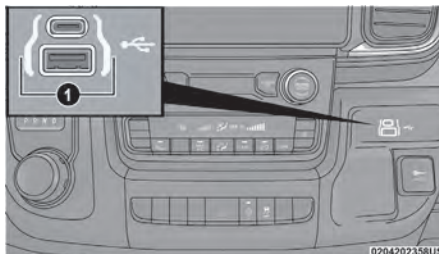

USB Ports

1 — Media USB C and A Ports

By using a USB cable to connect an external device:

- The device can be played on the vehicle's sound system, providing the artist, track title, and album information on the radio display.

NOTE:

Depending on track configuration, track information may not be present on the radio display.

- The device can be controlled using the radio buttons to play, and browse the contents of the device.
- The audio device battery charges when plugged into the USB port.

NOTE:

Charging unsupported devices with the Charge Only USB ports. If an unsupported device is plugged into a Media USB port, a message will display on the touchscreen that the device is not supported by the system.

POWER OUTLETS

Passenger Compartment Power Outlet

The power outlet is located on the instrument panel to the right of the radio. It only operates with the ignition in the ON/RUN position.

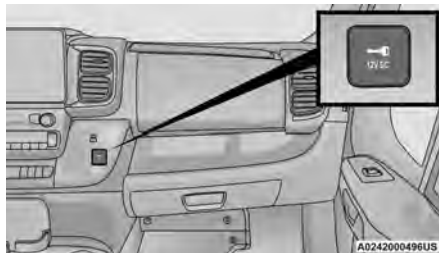

Passenger Compartment Power Outlet

Load Compartment Power Outlet — If Equipped

The load compartment power outlet is located in the rear cargo compartment. The outlet can be used for powering 12 Volt adapter accessories and recharging communications devices.

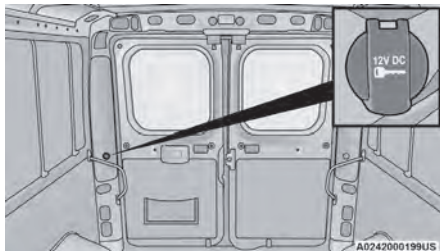

Load Compartment Power Outlet

NOTE:

Do not connect devices with power higher than 180 W to the socket. Do not damage the socket by using unsuitable adapters.

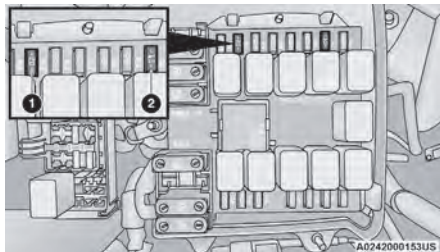

Power Outlet Fuses – Under Hood

- 1 – F14 Fuse 20 Amp Yellow Front Power Outlet
2 – F09 Fuse 15 Amp Blue Rear Power Outlet

WARNING!

To avoid serious injury or death:

- Only devices designed for use in this type of outlet should be inserted into any 12 Volt outlet.
- Do not touch with wet hands.
- Close the lid when not in use and while driving the vehicle.
- If this outlet is mishandled, it may cause an electric shock and failure.

CAUTION!

- Many accessories that can be plugged in draw power from the vehicle's battery, even when not in use (i.e., cellular phones, etc.). Eventually, if plugged in long enough, the vehicle's battery will discharge sufficiently to degrade battery life and/or prevent the engine from starting.
- Accessories that draw higher power (i.e., coolers, vacuum cleaners, lights, etc.) will degrade the battery even more quickly. Only use these intermittently and with greater caution.
- After the use of high power draw accessories, or long periods of the vehicle not being started (with accessories still plugged in), the vehicle must be driven a sufficient length of time to allow the generator to recharge the vehicle's battery.

POWER INVERTER – IF EQUIPPED

There is a 115 Volt, 150 Watt inverter outlet located on the instrument panel, to the right of the radio, to convert DC current to AC current. This outlet can power

cellular phones, electronics and other low power devices requiring power up to 150 Watts. Certain game consoles will exceed this power limit, as will most power tools.



Power Inverter Location

To turn on the power inverter outlet, simply plug in the device. The outlet automatically turns off when the device is unplugged.

The power inverter is designed with built-in overload protection. If the power rating of 150 Watts is exceeded, the power inverter will automatically shut down. Once the electrical device has been removed from the outlet the inverter should automatically reset. To avoid overloading the circuit, check the power ratings on electrical devices prior to using the inverter.

WARNING!

- To avoid serious injury or death:
- Do not insert any objects into the receptacles.
 - Do not touch with wet hands.
 - Close the lid when not in use.

(Continued)

WARNING!

- If this outlet is mishandled, it may cause an electric shock and failure.

AUXILIARY SWITCHES — IF EQUIPPED

Your vehicle may be equipped with two auxiliary switches located on the instrument panel to the left of the steering column which can be used to power various electronic devices. Connections to the switches are found in the right central pillar fuse panel at the base of the passenger side B-pillar.

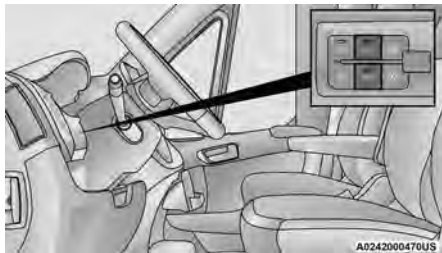

Auxiliary Switches

Auxiliary Switch 1 is configured to constant battery feed, while Auxiliary Switch 2 is configured to ignition feed.

For further information on using the auxiliary switches, please refer to the Ram Body Builder's Guide by accessing www.rambodybuilder.com and choosing the appropriate links.

WIRELESS CHARGING PAD — IF EQUIPPED

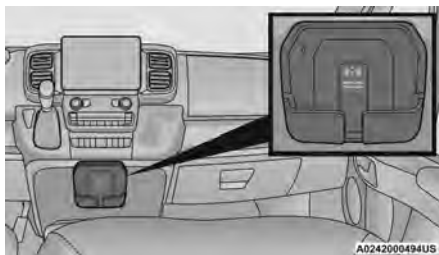

Wireless Charging Pad

Your vehicle may be equipped with a 15W 3A Qi® wireless charging pad located below the center stack, within the storage compartment. This charging pad is designed to wirelessly charge your Qi® enabled mobile phone. Qi® is a standard that allows wireless charging of your mobile phone.

Your mobile phone must be designed for Qi® wireless charging. If the phone is not equipped with Qi® wireless charging functionality, an aftermarket sleeve or a specialized back plate can be purchased from your mobile phone provider or a local electronics retailer. Please see your phone's Owner's Manual for further information.

The wireless charging pad is equipped with an anti-slip mat to hold your mobile phone in place, and an LED indicator light.

Place the device inside the prepared area delimited in the mat as shown in the image. Incorrect positioning will prevent the phone from charging.

LED Indicator Status:

- No Light: Charging pad is idle or searching for a device. Device may not be compatible with the Qi® standard.
- Blue Light: Device is detected and is charging.
- Red Light/Flashing: Internal error, or foreign object is detected.
- Green Light: Device has completed battery charging (if device is equipped to transmit this information).

Important Notes Regarding This Vehicle's Wireless Charging Pad:

- The presence of the Near-Field Communication (NFC) function active on a smartphone could signal malfunction anomalies.
- The ignition must be in the ON/RUN position in order for the phone to charge.
- To avoid interference with the key fob search, the wireless charging pad will stop charging when any door or liftgate is opened, even if the engine is running.
- Be sure to place the mobile device correctly (display facing upward, and phone not covering the LED) on the wireless charging pad.
- If the phone moves on the pad causing the red light to illuminate, the phone will have to be picked up and placed back on the charging pad to resume charging.
- Wireless charging is not as fast as when the phone is connected to a wired charger.
- The phone's protective case must be removed when placed on the wireless charging pad.

- iPhone® 12 (including iPod®) is equipped with software to protect the device from overheating. When the software is active, the rate of charge is slowed down to protect the device.
- Phones must always be placed on the wireless charging pad within the outline shown on the pad so that its charging parts connect with the charging coils of the system. Movement of the phone during charging may prevent or slow the rate of charge.
- Having multiple applications open on the phone while charging will reduce the charging efficiency, and may even shut down an application that is actively running (i.e. Apple CarPlay®). This may also cause the phone to overheat.
- Wireless chargers may implement certain methods to prevent the phone from overheating during charging such as slowing down the rate of charge. In certain instances, the device may shut down for a brief period of time (when the device reaches a certain temperature). If this happens, it does not mean there is a fault with the wireless charging pad. This may just be a protective measure to prevent damage to the phone.
- The use of multiple wireless functions at the same time (wireless charging, Apple CarPlay®, Android Auto™) could cause the device to overheat, resulting in limitation of the functions or it turning off. In this case, it is recommended to connect the system using the USB port.
- Do not place the key fob or any other type of metal/magnetized object inside the mobile phone housing or near the wireless charging pad.
- With a compatible device placed on the charging pad, and the ignition is cycled to the OFF position, a reminder message may appear on the instrument cluster display to warn the driver.

CAUTION!

The key fob should not be placed on the charging pad or within 6 inches (15 cm) of it. Doing so can cause excessive heat buildup and damage to the fob. Placing the fob in close proximity of the charging pad blocks the fob from being detected by the vehicle and prevents the vehicle from starting.

WINDOWS**POWER WINDOWS**

The control on the left front door panel has switches that control all power windows. There is a single opening and closing switch on the front passenger door for passenger window control.

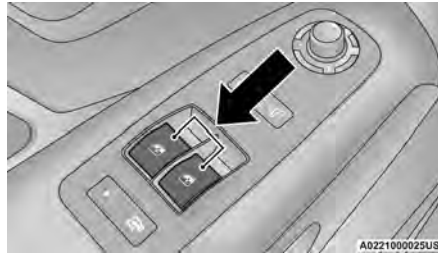
**Power Window Switches****NOTE:**

The Key Off Power Delay feature will allow the power windows to operate for up to three minutes after the ignition is placed in the OFF position. This feature is canceled when either front door is opened.

WARNING!

- Never leave children alone in a vehicle, or with access to an unlocked vehicle. Allowing children to be in a vehicle unattended is dangerous for a number of reasons. A child or others could be seriously or fatally injured. Children should be warned not to touch the parking brake, brake pedal or the gear selector.
- Do not leave the key fob in or near the vehicle or in a location accessible to children, and do not leave the Keyless Enter 'n Go™ Ignition in the ON/RUN position. Occupants, particularly unattended children, can become entrapped by the windows while operating the power window switches. Such entrapment may result in serious injury or death.

Automatic Window Features — If Equipped**Auto-Down Feature**

The window switches may be equipped with an Auto-Down feature. Push the window switch for half a second, release, and the window will go down automatically.

To stop the window from going all the way down during the auto-down operation, pull up or push down on the switch briefly.

To open the window part way, lift the window switch to the detent for less than half a second and release it to stop the window.

WARNING!

There is no auto-reverse protection. Be sure to clear all objects from the window before closing.

MANUAL SLIDING WINDOW — IF EQUIPPED

Vehicles equipped with a passenger pocket door have a manual sliding window.

A locking device in the center of the window helps to prevent entry from the side of the vehicle. Squeeze the lock to release the window.

WARNING!

- Never leave children alone in a vehicle, or with access to an unlocked vehicle. Allowing children to be in a vehicle unattended is dangerous for a number of reasons. A child or others could be seriously or fatally injured. Children should be warned not to touch the parking brake, brake pedal or the gear selector.
- Do not leave the key fob in or near the vehicle or in a location accessible to children, and do not leave the Keyless Enter 'n Go™ Ignition in the ON/RUN position. Occupants, particularly unattended children, can become entrapped by the windows while operating the power window switches. Such entrapment may result in serious injury or death.

WINDOW BAR GRATES — IF EQUIPPED

This vehicle may be equipped with metal grates over the sliding door windows. This feature is a part of the vehicle's safety system, and is designed to protect you and your passengers in the event of an accident.

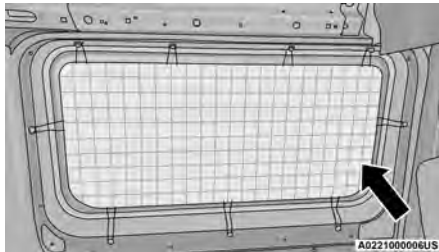
**Window Bar Grates****WARNING!**

The metal grates over the sliding door windows are designed to protect you in the event of an accident. Modification or removal of the grates could lead to serious injury or death.

WIND BUFFETING

Wind buffeting can be described as the perception of pressure on the ears or a helicopter-type sound in the ears. Your vehicle may exhibit wind buffeting with the windows down, or the sunroof/Power Sliding Top (if equipped) in certain open or partially open positions. This is a normal occurrence and can be minimized. If the buffeting occurs with the rear windows open, open

the front and rear windows together to minimize the buffeting. If the buffeting occurs with the sunroof open, adjust the sunroof opening to minimize the buffeting or open any window.

HOOD OPENING**WARNING!**

For BEV models: Always place the ignition in the OFF position before opening the hood. If the ignition is in the RUN position and the Propulsion System is active when the hood is opened, the electric motor could automatically start, and persons not clear of the vehicle could be injured by the electric motor's moving parts.

To open the hood, two latches must be released.

1. Pull the hood release lever located on the side of the instrument panel.

**Hood Release**

2. Move to the outside of the vehicle, reach into the opening beneath the center of the hood and push the safety latch lever upwards to release it, before raising the hood.

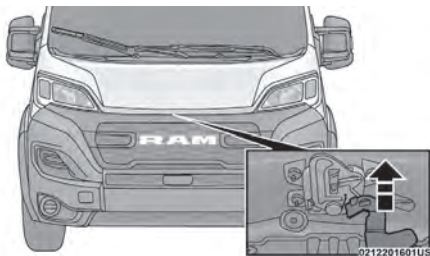

Hood Safety Latch Lever Location

3. Raise the hood and place the hood prop rod in hood slot to secure the hood in the open position.

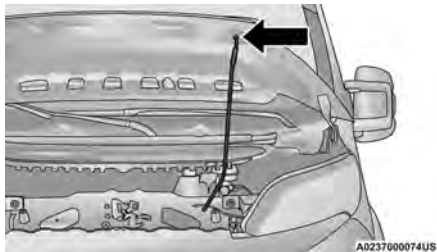

Hood Prop Rod Slot

NOTE:

- Vehicle must be at a stop and the gear selector must be in PARK.
- You may have to push down slightly on the hood before pushing the safety latch.
- While lifting the hood, use both hands.
- Before lifting the hood, check that the wiper arms are not in motion and not in the lifted position.
- **For BEV Models:** If the vehicle was actively charging the high voltage battery when the hood was opened, the vehicle will stop charging until the hood is closed.
- **For BEV models:** Electric drive mode will not be available while the hood is open. A message will show in the instrument cluster display to alert the driver.

CAUTION!

Be sure to disengage the rod and secure it in closed position before closing the hood. Damage may occur.

CLOSING

WARNING!

Be sure the hood is fully latched before driving your vehicle. If the hood is not fully latched, it could open when the vehicle is in motion and block your vision. Failure to follow this warning could result in serious injury or death.

CAUTION!

To prevent possible damage:

- Before closing hood, make sure the hood prop rod is fully seated into its storage retaining clips.
- Do not slam the hood to close it. Use a firm downward push at the center front edge of the hood to ensure that both latches engage. Never drive your vehicle unless the hood is fully closed, with both latches engaged.

2

CARGO AREA FEATURES

The cargo area may be equipped with different options such as optional side panels, rear seats and an optional floor.

GETTING TO KNOW YOUR INSTRUMENT PANEL

BASE / MIDLINE INSTRUMENT CLUSTER



Use this QR code to access your digital experience.



BASE / MIDLINE INSTRUMENT CLUSTER DESCRIPTIONS

1. Speedometer

- Indicates vehicle speed.

2. Instrument Cluster Display

- The instrument cluster display features a driver interactive display → page 69.

3. Tachometer

- Indicates the engine speed in revolutions per minute (RPM x 1000).

4. Fuel Gauge

- The gauge shows the level of fuel in the fuel tank when the ignition switch is in the ON/RUN position.
- The fuel pump symbol points to the side of the vehicle where the fuel door is located.



5. Temperature Gauge

- The temperature gauge shows engine coolant temperature. Any reading within the normal range indicates that the engine cooling system is operating satisfactorily.
- The gauge pointer will likely indicate a higher temperature when driving in hot weather or up mountain grades. It should not be allowed to exceed the upper limits of the normal operating range.

WARNING!

A hot engine cooling system is dangerous. You or others could be badly burned by steam or boiling coolant. It is recommended to call an authorized dealer for service if your vehicle overheats → page 224.

CAUTION!

Driving with a hot engine cooling system could damage your vehicle. If the temperature gauge reads "H" pull over and stop the vehicle. Idle the vehicle with the air conditioner turned off until the pointer drops back into the normal range. If the pointer remains on the "H", turn the engine off immediately and call an authorized dealer for service.

NOTE:

The hard telltales will illuminate for a bulb check when the ignition is first cycled.

PREMIUM INSTRUMENT CLUSTER



Use this QR code to access your digital experience.



PREMIUM INSTRUMENT CLUSTER DESCRIPTIONS

1. Tachometer

- This gauge measures engine revolutions per minute (RPM x 1000). Before the pointer reaches the red area, ease up on the accelerator to prevent engine damage.

2. Instrument Cluster Display

- When the appropriate conditions exist, this display shows instrument cluster display messages → page 69.
- Odometer/Trip Odometer Display Area
US Federal regulations require that upon transfer of vehicle ownership, the seller certify to the purchaser the correct mileage that the vehicle has been driven. If your odometer needs to be repaired or serviced, the repair technician should leave the odometer reading the same as it was before the repair or service. If the technician cannot do so, then the odometer must be set at zero, and a sticker must be placed in the door jamb stating what the mileage was before the repair or service. It is a good idea for you to make a record of the odometer reading before the repair/service, so

that you can be sure that it is properly reset, or that the door jamb sticker is accurate if the odometer must be reset at zero.

○ Gear Selector Status (PRND)

The gear selector status "P, R, N, D, 1, 2, 3, 4, etc." are displayed indicating the gear selector position. Telltales "1, 2, 3, 4, etc." indicate the manual mode has been engaged and the gear selected is displayed → page 91.

3. Temperature Gauge

- The temperature gauge shows engine coolant temperature. Any reading within the normal range indicates that the engine cooling system is operating satisfactorily.
- The pointer will likely indicate a higher temperature when driving in hot weather or up mountain grades. It should not be allowed to exceed the upper limits of the normal operating range.

WARNING!

A hot engine cooling system is dangerous. You or others could be badly burned by steam or boiling coolant. You may want to call an authorized dealer for service if your vehicle overheats.

CAUTION!

Driving with a hot engine cooling system could damage your vehicle. If the temperature gauge reads "H," pull over and stop the vehicle. Idle the vehicle with the air conditioner turned off until the pointer drops back into the normal range. If the pointer remains on the "H," turn the engine off immediately and call an authorized dealer for service.

4. Fuel Gauge

- The pointer shows the level of fuel in the fuel tank when the ignition switch is in the ON/RUN position.
- The fuel pump symbol points to the side of the vehicle where the fuel door is located → page 126.



5. Speedometer

- Indicates vehicle speed.

PREMIUM INSTRUMENT CLUSTER — BEV (Battery Electric Vehicle)



PREMIUM INSTRUMENT CLUSTER DESCRIPTIONS — BEV

1. Battery Level Gauge

- Indicates the battery level.

2. Instrument Cluster Display

- The instrument cluster display features a driver interactive display. When the appropriate conditions exist, this display shows messages
➔ page 68.

3. % Power/Charge Gauge

- Indicates vehicle power. The upper half of the gauge is the amount of battery power applied to move the vehicle. Bottom half indicates when the battery is charging via regenerative braking, while slowing the vehicle down.

4. Speedometer

- Indicates vehicle speed.

INSTRUMENT CLUSTER DISPLAY

Your vehicle will be equipped with an instrument cluster display, which offers useful information to the driver. With the ignition in the OFF mode, opening/closing of a door will activate the display for viewing, and display the total miles, or kilometers, in the odometer. Your instrument cluster display is designed to display important information about your vehicle's systems and features. Using a driver interactive display located on the instrument panel, your instrument cluster display can show you how systems are working and give you warnings when they are not. The steering wheel mounted con-

trols allow you to scroll through the main menus and submenus. You can access the specific information you want and make selections and adjustments.

CAUTION!

The simultaneous illumination of multiple safety warning lights can signal the failure of the instrument cluster display. If this happens contact an authorized dealer

LOCATION AND CONTROLS

The instrument cluster display features a driver interactive display that is located in the instrument cluster.

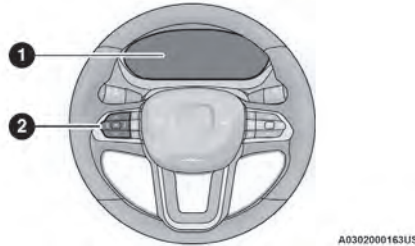

Instrument Cluster Display and Controls

- 1 - Instrument Cluster Display Screen
- 2 - Instrument Cluster Display Controls

This system allows the driver to select a variety of useful information by pushing the switches mounted on the instrument panel. Examples of menu items are:

- Buzzer Volume

- Exit Menu

If equipped with a Uconnect system, some customer programmable features will display in the radio
➔ page 136.

The system allows the driver to select information by pushing the following buttons mounted on the instrument panel to the left of the steering column:

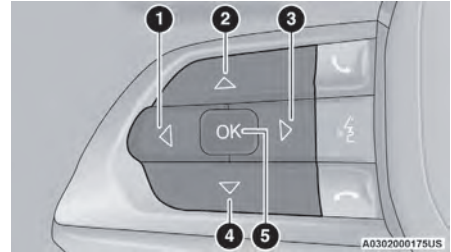

Instrument Cluster Display Control Buttons

- 1 — Left Arrow Button
- 2 — Up Arrow Button
- 3 — Right Arrow Button
- 4 — Down Arrow Button
- 5 — OK Button

7 Inch Instrument Cluster Display

- Left and Right Arrow Buttons

Push and release the **left** ◀ or **right** ▶ arrow button to navigate and access the information screens or the main menu screens.

- **Up and Down Arrow Buttons**

Push and release the **up** \triangle or **down** ∇ arrow button to scroll upward or downward through the submenus.

- **OK Button**

Push the **OK** button to access/select the information screens or submenu screens of a main menu item. Push and hold the **OK** button for one second to reset displayed/selected features that can be reset.

3.5 Inch Instrument Cluster Display

- **Up and Down Arrow Buttons**

Push and release the **up** \triangle or **down** ∇ arrow button to navigate and access the information screens or the main menu screens.

- **Left and Right Arrow Buttons**

Push and release the **left** \triangleleft or **right** \triangleright arrow button to scroll upward or downward through the submenus.

- **OK Button**

Push the **OK** button to access/select the information screens or submenu screens of a main menu item. Push and hold the **OK** button for one second to reset displayed/selected features that can be reset.

NOTE:

Press the **OK** button to toggle between mph or km/h.

STOP SAFELY VEHICLE WILL SHUT OFF SOON



Stop Safely Vehicle Will Shut Off Soon Warning Message

This warning will be displayed on the instrument panel display when the vehicle has determined an operational issue will occur shortly, which will cause the vehicle's propulsion system to turn off. If the light turns on while driving, stop the vehicle in a safe location as soon as possible. Have the vehicle transported to an authorized dealer.

- This is a high priority message
- This message will be displayed continuously
- Cannot be cleared with button press
- A single chime will sound

STOP SAFELY AND LEAVE THE VEHICLE AS SOON AS POSSIBLE



Stop Safely And Leave The Vehicle As Soon As Possible Warning Message

A warning will appear on the instrument panel display if the system detects the high voltage battery has overheated. This can result in a vehicle fire, and the release of toxic and/or flammable gases. To reduce the risk of a larger fire, the vehicle's high voltage propulsion system will turn off within thirty seconds of displaying this warning. At that time, the vehicle may not accelerate. You can still steer and brake the vehicle.

- This message will be displayed continuously
- Cannot be cleared with button press
- A continuous and rapid chime will sound. Stop and park the vehicle in an open area. Have all passengers exit the vehicle as soon as possible and move to a safe distance away from the vehicle. After all passengers safely exit the vehicle, call emergency

responders immediately. Even if you do not see flames, a fire may start at any moment, so do not attempt to re-enter or start the vehicle.

CHANGE ENGINE OIL — IF EQUIPPED

Use this QR code to access your digital experience.



Your vehicle is equipped with an engine oil change indicator system. The “Change Engine Oil” message will display in the instrument cluster display.

The engine oil change indicator system is duty cycle based, which means the engine oil change interval may fluctuate, dependent upon your personal driving style.

Unless reset, this message will continue to display each time you turn the ignition switch to the ON/RUN position. To turn off the message temporarily, push and release the **OK** button. To reset the oil change indicator system (after performing the scheduled maintenance), refer to the following procedure.

1. Turn the ignition switch to the ON position (do not start the engine).
2. Fully push the accelerator pedal slowly, three times, within 10 seconds.
3. Turn the ignition switch to the OFF position.

NOTE:

If the indicator message illuminates when you start the vehicle, the oil change indicator system did not reset. If necessary, repeat this procedure.

MAIN MENU

NOTE:

All of the following items are accessed by pressing the **OK** button.

Home with Enhanced Speedometer — If Equipped

This option features an enhanced bar graph speedometer to visually represent current speed. When a speed control system is active, the graph also provides visual cues for the different states of that particular speed control system.

Trip

Vehicles with 7 Inch Instrument Cluster Display

Access to trip information is available through the following submenus.

- **Instant Fuel Consumption** – Shows the instant consumption in real time (MPG or L/100 km or km/L).
- **Average Fuel Economy** – Shows the average consumption (MPG or L/100 km or km/L) of Trip A or Trip B since the last reset.
- **Distance — If Equipped** – Shows the total distance (mi or km) traveled for Trip A or Trip B since the last reset.
- **Distance to Empty** – Shows the remaining range till empty (mi or km).
- **Average Speed** – Shows the average speed (MPH or KM/H) of Trip A or Trip B since the last reset.
- **Travel Time** – Shows the total elapsed time of travel since Trip A or Trip B has been reset.

Hold the **OK** button to reset feature information.

NOTE:

During the reset the instruction line disappears and a bar graph appears to indicate the resetting status; when the bar graph is full the reset is complete.

Battery Electric Vehicle with 7 Inch Instrument Cluster Display

Access to trip information is available through the following submenus.

- **Instant Fuel Consumption** – Shows the instant consumption in real time (MPGe or mi/kWh or kWh/mi or kWh/100 km or km/kWh).
- **Average Fuel Economy** – Shows the average consumption (MPGe or mi/kWh or kWh/mi or kWh/100 km) of Trip A or Trip B since the last reset.
- **Distance — If Equipped** – Shows the total distance (mi or km) traveled for Trip A or Trip B since the last reset.
- **Average Speed** – Shows the average speed (MPH or KM/H) of Trip A or Trip B since the last reset.
- **Travel Time** – Shows the total elapsed time of travel since Trip A or Trip B has been reset.

Hold the **OK** button to reset feature information.

NOTE:

During the reset the instruction line disappears and a bar graph appears to indicate the resetting status; when the bar graph is full the reset is complete.

Vehicles with 3.5 Inch Instrument Cluster Display

- **Instant Information** – Shows the instantaneous consumption (MPG or L/100 km or km/L) and distance to empty (mi or km).
- **Trip A** – Shows the total distance (mi or km) traveled, the total elapsed time of travel, average consumption (MPG or L/100 km or km/L), and the average speed (MPH or KM/H).

- **Trip B** – Shows the total distance (mi or km) traveled, the total elapsed time of travel, average consumption (MPG or L/100 km or km/L), and the average speed (MPH or KM/H).

Hold the **OK** button to reset feature information.

Driver Assist

The Driver Assist systems are electronic aids designed to offer the driver help in certain driving situations

↪ page 98

Vehicle Info

Tire Pressure (TPMS)

TPMS shows the tire status with the numeric pressure and the unit for each tire, when low pressure is detected an alert message and a yellow telltale will pop-up in the instrument cluster display ↪ page 164.

Oil Temperature – If Equipped

A bar graph in your instrument cluster display will show your current temperature of your oil.

Battery Voltage – If Equipped

A bar graph in your instrument cluster display will show your current battery voltage.

Service Information – If Equipped

This feature can provide information on scheduled maintenance. It will display either “Service Distance” or “Service Days” ↪ page 213.

Audio

Push and release the **up** ▲ or **down** ▼ arrow button until the Audio Menu icon/title is highlighted in the instrument cluster display. This menu will display the audio source information, including the Song name, Artist name, and audio source with an accompanying graphic.

Phone

This menu displays the current status of a phone connected to the vehicle via Bluetooth®.

If no phone is connected, the menu will not function when the **OK** button is pushed. Otherwise, if a phone is connected, push the **OK** button to enter the menu. The following items will display:

- Recent calls: displays a list of the last 10 calls.
- SMS reader: displays the last 10 text messages and if they are read or unread.
- Favorite numbers: displays a maximum of 10 favorite numbers.

Navigation

If activated, this menu item will display navigation status and directions.

Messages

This menu item allows you to display the information messages/malfunction stored.

The background color of the display varies according to the priorities of the failure:

- Failed Messages with low priority display in yellow.
- Failed Messages with high priority display in red.

Settings

NOTE:

Some items may be displayed and managed through the Uconnect system. This may vary according to your vehicle equipment. If equipped, the following menu/submenu items are available in the cluster display.

NOTE:

If equipped, some customer programmable features will display in the Uconnect system ↪ page 136.

3.5 INCH CLUSTER SETTINGS

*If Equipped			
Display	Screen Setup	Top Left	<ul style="list-style-type: none"> ● Compass* ● Outside Temp ● Date ● Time ● None
		Center	<ul style="list-style-type: none"> ● Menu Title ● Compass* ● Outside Temp ● Date ● Range To Empty ● Average Economy ● Current Economy ● Odometer ● Audio Info ● None
		Top Right	<ul style="list-style-type: none"> ● Compass* ● Outside Temp ● Date ● Time ● Ignition Status* ● None
		Restore Defaults	
	Language	—	Choose Language
	Automatic Reset Trip B	—	Never, Always, 2h, 8h
	Phone Repetition in Instrument Panel	—	On/Off
Navigation Repetition in Instrument Panel	—	On/Off	
Units *	—	—	<ul style="list-style-type: none"> ● US, Metric ● Imperial, Metric

*If Equipped			
Units *	Custom	Speed	MPH, Km/h
		Distance	Mi, Km
		Consumption	Km/L, L/100 km/mpg
		Pressure	Psi, Kpa, Bar
		Temperature	°C, °F
Clock & Date	Set Time	–	+ / - Selectors
	Set Format	–	12 hrs, 24 hrs
	Set Date	–	+ / - Selectors
Security	Passenger Airbag	Double Confirm	On / Off
	Speed Warning	–	+ / - Selectors
	Seat Belt Reminder	–	On / Off
	Hill Start Assist	–	On / Off
Brakes	Brake Service	–	–
	Auto Park Brake	–	On / Off
Safety & Assistance	Warning Buzzer Volume	–	Off, Low, Medium, High
	Backup Alarm	–	On / Off
	Forward Collision	–	Off, Audio, Audio Brake
	Forward Collision Sensitivity	–	Near, Medium, Far
	Side Distance Warning	–	On / Off
	ParkSense	–	Sound, Sound + Display
	Rear ParkSense Volume	–	Low, Medium, High
Front ParkSense Volume	–	Low, Medium, High	

*If Equipped			
Lights	Headlight Off Delay	—	0, 30, 60, 90
	Headlight Sensitivity	—	1, 2, 3
	Greeting lights	—	0, 30, 60, 90
	Cornering lights	—	On / Off
	Headlights With Wipers	—	On / Off
Doors & Locks	Auto Door Locks	—	On / Off
	Auto Unlock On Exit	—	On / Off
	Sound Horn With Lock	—	Off - First Press Off - Second Press
	Flash Headlights With Lock	—	On / Off
	Sound Horn With Remote Start	—	On / Off
	Passive Entry	—	Off, All Doors, Approach Door, or On / Off
Vehicle Shut Off	—	—	By selecting the item "Vehicle Shut Off", you can turn off the engine from the instrument cluster. This feature is available in the event of a Keyless Ignition system failure, and will display instructions for turning off the engine via the instrument cluster display controls.

7 INCH CLUSTER SETTINGS

*If Equipped			
Display	Screen Setup	Bottom Center	<ul style="list-style-type: none"> ● Odometer ● Audio Info ● Phone Info ● Time ● Temperature ● Date ● Compass* ● Ignition State*
		Bottom Right	<ul style="list-style-type: none"> ● Time ● Odometer ● Temperature ● Date ● Compass* ● Ignition State*
		Restore Defaults	
	Automatic Reset Trip B	—	Never, Always, 2h, 8h
	Phone Repetition in Instrument Panel	—	On/Off
	Navigation Repetition in Instrument Panel	—	Map, Pictogram, Off
	Security	Passenger Airbag	Double Confirm
Speed Warning		—	+ / - Selectors
Seat Belt Reminder		—	On / Off
Hill Start Assist		—	On / Off
Safety & Assistance	Warning Buzzer Volume	—	Off, Low, Medium, High
	Backup Alarm — If Equipped	—	On / Off

*If Equipped		
Vehicle Shut Off	—	— By selecting the item “Vehicle Shut Off”, you can turn off the engine from the instrument cluster. This feature is available in the event of a Keyless Ignition system failure, and will display instructions for turning off the engine via the instrument cluster display controls.

WARNING LIGHTS AND MESSAGES

The warning/indicator lights will illuminate in the instrument panel together with a dedicated message and/or acoustic signal when applicable. These indications are indicative and precautionary and as such must not be considered as exhaustive and/or alternative to the information contained in the Owner’s Manual, which you are advised to read carefully in all cases. Always refer to the information in this chapter in the event of a failure indication. All active telltales will display first if applicable. The system check menu may appear different based upon equipment options and current vehicle status. Some telltales are optional and may not appear.

RED WARNING LIGHTS

Air Bag Warning Light



This light will turn on for four to eight seconds as a bulb check when the ignition is placed in the ON/RUN or MAR/ON/RUN position. If the light is either not on during startup, stays on, or turns on while driving, have the system inspected at an authorized dealer as soon as possible. This light will illuminate with a single chime when a fault with the Air Bag Warning Light has been

detected, it will stay on until the fault is cleared. If the light comes on intermittently or remains on while driving, have an authorized dealer service the vehicle immediately.

Brake Warning Light



This warning light monitors various brake functions, including brake fluid level and parking brake application. If the brake light turns on it may indicate that the parking brake is applied, that the brake fluid level is low, or that there is a problem with the Anti-Lock Brake System reservoir.

If the light remains on when the parking brake has been disengaged, and the fluid level is at the full mark on the master cylinder reservoir, it indicates a possible brake hydraulic system malfunction or that a problem with the Brake Booster has been detected by the Anti-Lock Brake System (ABS) / Electronic Stability Control (ESC) system. In this case, the light will remain on until the condition has been corrected. If the problem is related to the brake booster, the ABS pump will run when applying the brake, and a brake pedal pulsation may be felt during each stop.

The dual brake system provides a reserve braking capacity in the event of a failure to a portion of the hydraulic system. A leak in either half of the dual brake

system is indicated by the Brake Warning Light, which will turn on when the brake fluid level in the master cylinder has dropped below a specified level.

The light will remain on until the cause is corrected.

NOTE:

The light may flash momentarily during sharp cornering maneuvers, which change fluid level conditions. The vehicle should have service performed, and the brake fluid level checked.

If brake failure is indicated, immediate repair is necessary.

WARNING!

Driving a vehicle with the red brake light on is dangerous. Part of the brake system may have failed. It will take longer to stop the vehicle. You could have a collision. Have the vehicle checked immediately.

Vehicles equipped with the Anti-Lock Brake System (ABS) are also equipped with Electronic Brake Force Distribution (EBD). In the event of an EBD failure, the Brake Warning Light will turn on along with the ABS Light. Immediate repair to the ABS system is required. Operation of the Brake Warning Light can be checked by turning the ignition switch from the OFF position to

the ON/RUN position. The light should illuminate for approximately two seconds. The light should then turn off unless the parking brake is applied or a brake fault is detected. If the light does not illuminate, have the light inspected by an authorized dealer.

The light also will turn on when the parking brake is applied with the ignition switch in the ON/RUN position.

NOTE:

This light shows only that the parking brake is applied. It does not show the degree of brake application.

Battery Charge Warning Light



This warning light will illuminate when the battery is not charging properly. If it stays on while the engine is running, there may be a malfunction with the charging system. Contact an authorized dealer as soon as possible.

This indicates a possible problem with the electrical system or a related component.

Door Open Warning Light



This indicator will illuminate when one or more door(s) are not fully closed. A pop-up appears on the instrument cluster display showing which door is open.

NOTE:

If the vehicle is moving and a door is opened, there will also be a single chime.

Drowsy Driver Detected Warning Light — If Equipped



The Drowsy Driver Detection system assists in preventing crashes caused by fatigued drivers by advising them to take a break from driving. Once a Drowsy Driver is detected, a pop-up will display continuously until the driver presses the **OK** button to clear.

Once the pop-up message is cleared, it is stored until the condition is no longer true.

Electric Power Steering (EPS) Fault Warning Light



This warning light will turn on when there's a fault with the EPS system → page 97.

WARNING!

Continued operation with reduced assist could pose a safety risk to yourself and others. Service should be obtained as soon as possible.

Service Electrical System Warning Light — If Equipped



This warning light will illuminate when service to the electrical system is needed. It will be accompanied by a message in the cluster. If the telltale stays on or continues to come on, contact an authorized dealer as soon as possible.

Electronic Throttle Control (ETC) Warning Light



This warning light will illuminate to inform of a problem with the ETC system. If a problem is detected while the vehicle is running, the light will either stay on or flash depending on the nature of the problem. Cycle the ignition when the vehicle is safely and completely stopped and the transmission is placed in the PARK (P) position. The light should turn off. If the light remains on with the vehicle running, your vehicle will usually be drivable; however, see an authorized dealer for service as soon as possible.

If the light continues to flash when the vehicle is running, immediate service is required and you may experience reduced performance, an elevated/rough idle, or engine stall and your vehicle may require towing. The light will come on when the ignition is placed in the ON/RUN or MAR/ON/RUN position and remain on briefly as a bulb check. If the light does not come on during starting, have the system checked by an authorized dealer.

Engine Temperature Warning Light



This light warns of an overheated engine condition. If the engine coolant temperature is too high, this indicator will illuminate and a single chime will sound.

If the light turns on while driving, safely pull over and stop the vehicle. If the Air Conditioning (A/C) system is on, turn it off. Also, shift the transmission into NEUTRAL and idle the vehicle. If the temperature reading does not return to normal, turn the engine off immediately and call for service → page 207.

Generic Warning Light



The Generic Warning Light will illuminate to signal the failure of one or more safety warning lights with a corresponding message. The safety systems that may cause the Generic Warning Light to illuminate include but are not limited to: Seat belt Reminder, Electric Park Brake, Brakes, Air Bag, and Swivel Seat failure.

The telltale will remain on in case of swivel seat failure and will blink in case of Air Bag Warning Light Failure. Contact an authorized dealer immediately for service.

Hood Open Warning Light



The telltale turns on when the hood is not properly closed. Along with the icon, an image of the vehicle with an open hood cap appears on the display.

Close the hood properly.

Rear Door Open Warning Light — If Equipped



This warning light will illuminate when the rear door is open.

NOTE:

This light will flash at a fast rate for approximately 15 seconds when the vehicle security system is arming, and then will flash slowly until the vehicle is disarmed.

Oil Pressure Warning Light



This warning light will illuminate to indicate low engine oil pressure. If the light turns on while driving, stop the vehicle, shut off the engine as soon as possible, and contact an authorized dealer. A chime will sound when this light turns on.

Do not operate the vehicle until the cause is corrected. This light does not indicate how much oil is in the engine. The engine oil level must be checked under the hood.

Plug Status Fault Warning Light



This warning light will illuminate when a plug status fault is detected (when vehicle not in motion). It will be accompanied by a cluster message indicating the type of fault. You may receive one of the following messages if a fault is detected:

- “Service Charging System” – If you see this message, it is recommended to unplug and plug in again, or try a different charging station. If an issue continues, contact an authorized dealer to service your high voltage charging system.
- “Issue Detected Check External Charging Station” – If you see this message, the charging station may be powered off, having internal fault or being scheduled to charge later. It is recommended to try a different charging station. If an issue continues, then contact an authorized dealer.

NOTE:

- Older or non-compliant J1772 EVSE models may not support charging of this vehicle. If this vehicle does not charge, it may be connected to a non-compliant Level 2 EVSE, and will flash indicators. Please identify this failure to the site operator and/or EVSE provider.
- Before this vehicle can be driven, the EVSE Charging Cord must be disconnected from the vehicle.

3

Seat Belt Reminder Warning Light



When the ignition is first placed in the ON/RUN or MAR/ON/RUN position, if the driver's seat belt is unbuckled, a chime will sound and the light will turn on. When driving, if the driver or front passenger seat belt remains unbuckled, the Seat Belt Reminder Light will flash or remain on continuously and a chime will sound [page 165](#).

Torque Limited Warning Light — If Equipped



This warning light illuminates when vehicle acceleration is limited due to a reduction in engine or electric motor performance. Contact your authorized dealer for service if illumination persists.

Transmission Fault Warning Light



This light will illuminate (together with a message in the instrument cluster display and a buzzer) to indicate a transmission fault. Contact an authorized dealer if the message remains after restarting the engine.

Traction Battery Fault Warning Light

This light alerts the driver that there is a failure in the Traction Battery System. Contact an authorized dealer if illumination persists.

Vehicle Security Warning Light — If Equipped

This light will flash at a fast rate for approximately 15 seconds when the vehicle security system is arming, and then will flash slowly until the vehicle is disarmed.

Swivel Seat (Driver or Passenger) Unlocked Warning Light — If Equipped

This light will illuminate when the driver or passenger seat is unlocked.

YELLOW WARNING LIGHTS**Adaptive Cruise Control (ACC) Fault Warning Light — If Equipped**

This warning light will illuminate to indicate a fault in the ACC system. Contact a local authorized dealer for service ➔ page 99.

Audio System Failure Warning Light — If Equipped

This light will illuminate to report a failure of the Audio System. Contact an authorized dealership as soon as possible.

Anti-Lock Brake System (ABS) Warning Light

This light monitors the ABS. The light will turn on when the ignition is placed in the ON/RUN or MAR/ON/RUN position and may stay on for as long as four seconds.

If the ABS light remains on or turns on while driving, then the Anti-Lock portion of the brake system is not functioning and service is required. However, the conventional brake system will continue to operate normally if the brake warning light is not on.

If the ABS light is on, the brake system should be serviced as soon as possible to restore the benefits of Anti-Lock Brakes. If the ABS light does not turn on when the ignition is placed in the ON/RUN or MAR/ON/RUN position, have the light inspected by an authorized dealer.

Acoustic Vehicle Alerting System (AVAS) Fault Warning Light — If Equipped

This light alerts the driver that the AVAS system is not functioning properly. If the light stays on contact and authorized dealer for service.

Immobilizer Fail / VPS Electrical Alarm Warning Light

This telltale will illuminate when the vehicle security system has detected an attempt to break into the vehicle.

NOTE:

After cycling the ignition to the ON/RUN position, the Vehicle Security Warning Light could illuminate if a problem with the system is detected. This condition will result in the engine being shut off after two seconds.

Drowsy Driver Detected System Fault Warning Light — If Equipped

This warning light will illuminate when the Drowsy Driver Detected System is not operating correctly and requires service. Please see an authorized dealer.

Electronic Stability Control (ESC) Warning Light

The ESC Indicator Light in the instrument cluster will come on when the ignition is placed in the ON/RUN or MAR (ACC/ON/RUN) position, and when ESC is activated. It should turn off with the engine running. If the ESC Indicator Light comes on continuously with the engine running, a malfunction has been detected in the ESC system. If this light remains on after several ignition cycles, and the vehicle has been driven several miles (kilometers) at speeds greater than 30 mph (48 km/h), see an authorized dealer as soon as possible to have the problem diagnosed and corrected.

- The ESC OFF Indicator Light and the ESC Indicator Light come on momentarily each time the ignition is placed in the ON/RUN or MAR (ACC/ON/RUN) position.
- Each time the ignition is turned to ON/RUN or MAR (ACC/ON/RUN), the ESC system will be on, even if it was turned off previously.
- The ESC system will make buzzing or clicking sounds when it is active. This is normal; the sounds will stop when ESC becomes inactive.
- This light will come on when the vehicle is in an ESC event.

Electronic Stability Control (ESC) OFF Warning Light



This light indicates the ESC is off.

Each time the ignition is turned to ON/RUN or MAR/ON/RUN, the ESC system will be on, even if it was turned off previously.

Low Fuel Warning Light



When the fuel level reaches the low threshold, this light will turn on and remain on until fuel is added.

Engine Check/Malfunction Indicator Light (MIL) Warning Light



The Engine Check/Malfunction Indicator Light (MIL) is a part of an Onboard Diagnostic System called OBD II that monitors engine and automatic transmission control systems. This warning light will illuminate when the igni-

tion is in the ON/RUN position before engine start. If the bulb does not come on when turning the ignition switch from OFF to ON/RUN, have the condition checked promptly.

Certain conditions, such as a loose or missing gas cap, poor quality fuel, etc., may illuminate the light after engine start. The vehicle should be serviced if the light stays on through several typical driving styles. In most situations, the vehicle will drive normally and will not require towing.

When the engine is running, the MIL may flash to alert serious conditions that could lead to immediate loss of power or severe catalytic converter damage. The vehicle should be serviced by an authorized dealer as soon as possible if this occurs.

WARNING!

A malfunctioning catalytic converter can reach higher temperatures than in normal operating conditions. This can cause a fire if you drive slowly or park over flammable substances such as dry plants, wood, cardboard, etc. This could result in death or serious injury to the driver, occupants or others.

CAUTION!

Prolonged driving with the Malfunction Indicator Light (MIL) on could cause damage to the vehicle control system. It also could affect fuel economy and drivability. If the MIL is flashing, severe catalytic converter damage and power loss will soon occur. Immediate service is required.

Service Active Lane Management Warning Light — If Equipped



This warning light will illuminate when the Active Lane Management system is not operating and requires service. Please see an authorized dealer.

Service Forward Collision Warning (FCW) Light — If Equipped



This warning light will illuminate to indicate a fault in the FCW System or an external blockage on the frontal camera. Contact an authorized dealer for service.

Service Required/Call For Service Warning Light



This warning light will illuminate when service is needed. A pop-up will appear in the display to signal the need for service. Contact an authorized dealer as soon as possible.

Speed Limiter Fail Warning Light — If Equipped



This light will illuminate when there is a failure in the speed limiter system.

Swivel Seat (Driver or Passenger) Fail Warning Light — If Equipped



This light will illuminate when the driver or passenger swivel seat fails.

Tire Pressure Monitoring System (TPMS) Warning Light



The warning light switches on and a message is displayed to indicate that the tire pressure is lower than the recommended value and/or that slow pressure loss is occurring. In these cases, optimal tire duration and fuel consumption may not be guaranteed.

Should one or more tires be in the condition mentioned previously, the display will show the indications corresponding to each tire.

WARNING!

Do not continue driving with one or more flat tires as handling may be compromised. Stop the vehicle, avoiding sharp braking and steering. If a tire puncture occurs, repair immediately using the dedicated tire repair kit and contact an authorized dealer as soon as possible.

Each tire, including the spare (if provided), should be checked monthly when cold and inflated to the inflation pressure recommended by the vehicle manufacturer on the vehicle placard or tire inflation pressure label. If your vehicle has tires of a different size than the size

indicated on the vehicle placard or tire inflation pressure label, you should determine the proper tire inflation pressure for those tires.

As an added safety feature, your vehicle has been equipped with a TPMS that illuminates a low tire pressure telltale when one or more of your tires is significantly underinflated. Accordingly, when the low tire pressure telltale illuminates, you should stop and check your tires as soon as possible, and inflate them to the proper pressure. Driving on a significantly underinflated tire causes the tire to overheat and can lead to tire failure. Underinflation also reduces fuel efficiency and tire tread life, and may affect the vehicle's handling and stopping ability.

Please note that the TPMS is not a substitute for proper tire maintenance, and it is the driver's responsibility to maintain correct tire pressure, even if underinflation has not reached the level to trigger illumination of the TPMS low tire pressure telltale.

Your vehicle has also been equipped with a TPMS malfunction indicator to indicate when the system is not operating properly. The TPMS malfunction indicator is combined with the low tire pressure telltale. When the system detects a malfunction, the telltale will flash for approximately one minute and then remain continuously illuminated. This sequence will continue upon subsequent vehicle start-ups as long as the malfunction exists. When the malfunction indicator is illuminated, the system may not be able to detect or signal low tire pressure as intended. TPMS malfunctions may occur for a variety of reasons, including the installation of replacement or alternate tires or wheels on the vehicle that prevent the TPMS from functioning properly. Always check the TPMS malfunction telltale after replacing one or more tires or wheels on your vehicle to ensure that the replacement or alternate tires and wheels allow the TPMS to continue to function properly.

CAUTION!

The TPMS has been optimized for the original equipment tires and wheels. TPMS pressures and warning have been established for the tire size equipped on your vehicle. Undesirable system operation or sensor damage may result when using replacement equipment that is not of the same size, type, and/or style. Aftermarket wheels can cause sensor damage. Using aftermarket tire sealants may cause the Tire Pressure Monitoring System (TPMS) sensor to become inoperable. After using an aftermarket tire sealant it is recommended that you take your vehicle to an authorized dealer to have your sensor function checked.

Towing Hook Breakdown Warning Light — If Equipped



This light illuminates when there is a failure with the tow hook. Contact an authorized dealer for service.

Traction Battery Cut-off Warning Light — If Equipped



This telltale will turn on to indicate the Traction Battery system is not functioning properly. Contact an authorized dealer if illumination persists.

Transmission Temperature Warning Light



This warning light will illuminate to warn of a high transmission fluid temperature. This may occur with strenuous usage such as trailer towing. If this light turns on, stop the vehicle and run the engine at idle or slightly faster, with the transmission in PARK (P) or NEUTRAL (N), until the light turns off. Once the light turns off, you may continue to drive normally.

WARNING!

If you continue operating the vehicle when the Transmission Temperature Warning Light is illuminated you could cause the fluid to boil over, come in contact with hot engine or exhaust components and cause a fire.

CAUTION!

Continuous driving with the Transmission Temperature Warning Light illuminated will eventually cause severe transmission damage or transmission failure.

YELLOW INDICATOR LIGHTS

Forward Collision Warning (FCW) OFF Indicator Light — If Equipped



This indicator light will illuminate when you switch FCW off or when driving conditions obscure the sensor with snow, heavy rain, or sun.

TOW/HAUL Indicator Light



This indicator light will illuminate when TOW/HAUL mode is selected ↪ page 128.

Keyless System Failure Indicator Light



The telltale will illuminate in the event of keyless system failure.
Contact an authorized dealer as soon as possible.

Rain Sensor Failure Indicator Light



The telltale will illuminate in the case of failure of the automatic windshield wiper. Contact an authorized dealer as soon as possible.

Exterior Lights Failure Indicator Light



The telltale will illuminate to indicate a failure on the following lights: Daytime Running Lights (DRLs) / parking lights / trailer turn signal indicators (if present) / trailer lights (if present) / side lights / turn signal indicators / rear fog light / reversing light / brake lights / license plate lights.

The failure may be caused by a blown bulb, a blown protection fuse, or an interruption of the electrical connection. Replace the bulb or the relevant fuse. Contact an authorized dealer.

Fuel Cutoff Failure Indicator Light — If Equipped



This light will illuminate if there is a fuel cutoff failure. If this light illuminates, take it to an authorized dealer and have them inspect it.

3

GREEN INDICATOR LIGHTS

Active Lane Management Indicator Light — If Equipped



The Active Lane Management indicator light illuminates solid green when both lane markings have been detected and the system is “armed” and ready to provide visual and torque warnings if an unintentional lane departure occurs ↪ page 121.

Active Speed Limiter Set Indicator Light — If Equipped With A Premium Instrument Cluster



This indicator light will illuminate when the Active Speed Limiter is on and set to a specific speed ↪ page 98.

Automatic High Beam Indicator Light — If Equipped



This indicator shows that the automatic high beam headlights are on → page 47.

Cruise Control Indicator Light — If Equipped



This indicator light will illuminate when the cruise control is activated → page 99.

NOTE:

There will be no change in the indicator light when the desired speed is set.

Front Fog Indicator Light — If Equipped



This indicator light will illuminate when the front fog lights are on → page 47.

Parking/Headlights On Indicator Light



This indicator light will illuminate when the parking lights or headlights are turned on → page 47.

Plug Status Indicator Light



When plugged in, the green plug indicator light will illuminate if the Electric Vehicle Supply Equipment (EVSE) charging plug is securely attached to the charging port. This

indicates that the plug is detected, but doesn't mean it is charging. It will be accompanied with a cluster message indicating the charge status:

- “Plugged In And Charging”
- “Plugged In And Waiting to Charge On A Set Schedule”
- “Plugged in and Charging Complete”

NOTE:

The vehicle cannot be driven until it is unplugged.

Ready To Drive Indicator Light



This indicator light will illuminate to indicate that the vehicle has enough power to be driven, regardless of the speed of the vehicle.

Turn Signal/Hazard Warning Indicator Lights



The turn signal arrows will flash independently when left or right turn signals are selected. Turn signals can be activated when the multifunction lever is moved down (left) or up (right).

Pressing the Hazard Warning Flashers button will illuminate both right and left turn signal arrows simultaneously → page 186.

NOTE:

Check for an inoperative outside light bulb if either indicator flashes at a rapid rate.

BLUE INDICATOR LIGHTS

High Beam Indicator Light



This indicator light will illuminate to indicate that the high beam headlights are on. With the low beams activated, push the multifunction lever forward (toward the front of the vehicle) to turn on the high beams. Pull the multifunction lever rearward (toward the rear of the vehicle) to turn off the high beams. If the high beams are off, pull the lever toward you for a temporary high beam on, “flash to pass” scenario.

WHITE INDICATOR LIGHTS

Adaptive Cruise Control (ACC) Set With Target Indicator Light — If Equipped



This will display when the ACC is set and a vehicle in front is detected → page 99.

Active Lane Management Indicator Light — If Equipped



When the Active Lane Management system is ON, but not armed, the Active Lane Management indicator light illuminates solid white. This occurs when only left, right, or neither lane line has been detected. If a single lane line is detected, the system is ready to provide only visual warnings if an unintentional lane departure occurs on the detected lane line → page 121.

Active Speed Limiter Ready Indicator Light — If Equipped With A Premium Instrument Cluster



This light will illuminate when the Active Speed Limiter has been turned on, but not set. ↪ page 98.

Speed Warning Indicator Light — If Equipped



When Set Speed Warning is turned on, the speed warning telltale will illuminate in the instrument cluster with a number matching the set speed. When the set speed is exceeded, a single chime will sound along with pop-up message of speed warning exceeded.

Speed Warning can be turned on and off in the instrument cluster display ↪ page 69.

NOTE:

The number “55” is only an example of a speed that can be set.

ONBOARD DIAGNOSTIC SYSTEM — OBD II

Your vehicle is equipped with a sophisticated Onboard Diagnostic system called OBD II. This system monitors the performance of the emissions, engine, and transmission control systems. When these systems are operating properly, your vehicle will provide excellent performance and fuel economy, as well as engine emissions well within current government regulations.

If any of these systems require service, the OBD II system will turn on the Malfunction Indicator Light (MIL). It will also store diagnostic codes and other information to assist your service technician in making repairs.

Although your vehicle will usually be drivable and not need towing, see an authorized dealer for service as soon as possible.

CAUTION!

- Prolonged driving with the MIL on could cause further damage to the emission control system. It could also affect fuel economy and driveability. The vehicle must be serviced before any emissions tests can be performed.
- If the MIL is flashing while the vehicle is running, severe catalytic converter damage and power loss will soon occur. Immediate service is required.

ONBOARD DIAGNOSTIC SYSTEM (OBD II) CYBERSECURITY

Your vehicle is required to have an OBD II and a connection port to allow access to information related to the performance of your emissions controls. Authorized service technicians may need to access this information to assist with the diagnosis and service of your vehicle and emissions system ↪ page 136.

WARNING!

- ONLY an authorized service technician should connect equipment to the OBD II connection port in order to read the VIN, diagnose, or service your vehicle.
- If unauthorized equipment is connected to the OBD II connection port, such as a driver-behavior tracking device, it may:
 - Be possible that vehicle systems, including safety related systems, could be impaired or a loss of vehicle control could occur that may result in an accident involving serious injury or death.

(Continued)

WARNING!

- Access, or allow others to access, information stored in your vehicle systems, including personal information.

EMISSIONS INSPECTION AND MAINTENANCE PROGRAMS

In some localities, it may be a legal requirement to pass an inspection of your vehicle's emissions control system. Failure to pass could prevent vehicle registration.



For states that require an Inspection and Maintenance (I/M), this check verifies the Malfunction Indicator Light (MIL) is functioning and is not on when the engine is running, and that the OBD II system is ready for testing.

The OBD II system may **not** be ready if your vehicle was recently serviced, recently had a depleted battery or a battery replacement. If the OBD II system should be determined not ready for the I/M test, your vehicle may fail the test.

Your vehicle has a simple ignition actuated test, which you can use prior to going to the test station. To check if your vehicle's OBD II system is ready, you must do the following:

1. Switch the ignition to the ON position, but do not crank or start the engine.

NOTE:

If you crank or start the engine, you will have to start this test over.

2. As soon as you cycle the ignition switch to the ON position, you will see the Malfunction Indicator Light (MIL) symbol come on as part of a normal bulb check.
3. Approximately 15 seconds later, one of two things will happen:
 - The MIL will flash for about 10 seconds and then return to being fully illuminated until you turn OFF the ignition or start the engine. This means that your vehicle's OBD II system is **not ready** and you should **not** proceed to the I/M station.
 - The MIL will not flash at all and will remain fully illuminated until you place the ignition in the off position or start the engine. This means that your vehicle's OBD II system is **ready** and you can proceed to the I/M station.

If your OBD II system is **not ready**, you should see an authorized dealer or repair facility. If your vehicle was recently serviced or had a battery failure or replacement, you may need to do nothing more than drive your vehicle as you normally would in order for your OBD II system to update. A recheck with the previously mentioned test routine may then indicate that the system is **now ready**.

STARTING AND OPERATING

STARTING THE ENGINE

Before starting your vehicle, adjust your seat, adjust both inside and outside mirrors, and fasten your seat belts.

WARNING!

- Never leave children alone in a vehicle, or with access to an unlocked vehicle.
- Allowing children to be in a vehicle unattended is dangerous for a number of reasons. A child or others could be seriously or fatally injured. Children should be warned not to touch the parking brake, brake pedal or the transmission gear selector.
- Do not leave the key fob in or near the vehicle (or in a location accessible to children). A child could operate power windows, other controls, or move the vehicle.

AUTOMATIC TRANSMISSION

The gear selector must be in the PARK or NEUTRAL position before you can start the engine.

NOTE:

You must press the brake pedal before shifting out of PARK.

NORMAL STARTING

NOTE:

Normal starting of either a cold or warm engine is obtained without pumping or pressing the accelerator pedal.

Proceed as follows:

1. The transmission must be in PARK (P).
2. Press and hold the brake pedal while pushing the ENGINE START/STOP button once.
3. If the engine does not start after 10 seconds, place the ignition in the OFF position and wait 10-15 seconds before attempting to restart the engine.

TIP START FEATURE

Do not press the accelerator. Press briefly the START/STOP ignition button and release it. The starter motor will continue to run but will automatically disengage when the engine is running.

COLD WEATHER OPERATION (BELOW -22°F OR -30°C)

To ensure reliable starting at these temperatures, use of an externally powered electric engine block heater (available from an authorized dealer) is recommended.

EXTENDED PARK STARTING

NOTE:

Extended Park condition occurs when the vehicle has not been started or driven for at least 30 days.

1. Install a battery charger or jumper cables to the battery to ensure a full battery charge during the crank cycle.
2. Press and hold the brake pedal while pushing the ENGINE START/STOP button once.
3. If the engine fails to start within 10 seconds, place the ignition in the OFF position, wait 10 to 15 seconds to allow the starter to cool, then repeat the "Extended Park Starting" procedure.
4. If the engine fails to start after eight attempts, allow the starter to cool for at least 10 minutes, then repeat the procedure.

CAUTION!

To prevent damage to the starter, do not crank continuously for more than 10 seconds at a time. Wait 10 to 15 seconds before trying again.

IF ENGINE FAILS TO START

If the engine fails to start after you have followed the "Normal Starting" procedure, and the vehicle has not experienced an extended park condition as previously defined, it may be flooded. Push the accelerator pedal all the way to the floor and hold it there. Crank the

engine for no more than 10 seconds. This should clear any excess fuel in case the engine is flooded. Leave the ignition in the ON/RUN position, release the accelerator pedal and repeat the “Normal Starting” procedure.

WARNING!

- Never pour fuel or other flammable liquid into the throttle body air inlet opening in an attempt to start the vehicle. This could result in flash fire causing serious personal injury.
- Do not attempt to push or tow your vehicle to get it started. Vehicles equipped with an automatic transmission cannot be started this way. Unburned fuel could enter the catalytic converter and once the engine has started, ignite and damage the converter and vehicle.
- If the vehicle has a discharged battery, booster cables may be used to obtain a start from a booster battery or the battery in another vehicle. This type of start can be dangerous if done improperly → page 203.

CAUTION!

To prevent damage to the starter, do not continuously crank the engine for more than 10 seconds at a time. Wait 10 to 15 seconds before trying again.

AFTER STARTING

The idle speed is controlled automatically, and it will decrease as the engine warms up.

**STARTING THE VEHICLE — BEV
(IF EQUIPPED)**

Before starting your vehicle, adjust your seat, adjust both inside and outside mirrors, and fasten your seat belts.

WARNING!

- When exiting the vehicle, always remove the key fob from the vehicle and lock your vehicle.
- Never leave children alone in a vehicle, or with access to an unlocked vehicle.
- Allowing children to be in a vehicle unattended is dangerous for a number of reasons. A child or others could be seriously or fatally injured. Children should be warned not to touch the parking brake, brake pedal or the transmission gear selector.
- Do not leave the key fob in or near the vehicle, or in a location accessible to children, and do not leave the ignition of a vehicle equipped with Keyless Enter 'n Go™ in the ACC or ON/RUN position. A child could operate power windows, other controls, or move the vehicle.
- Do not leave children or animals inside parked vehicles in hot weather. Interior heat buildup may cause serious injury or death.

NORMAL STARTING

The transmission must be in the PARK or NEUTRAL position before you can start the vehicle. Apply the brakes when selecting a transmission gear from Park.

NOTE:

You must press the brake pedal before selecting a transmission gear.

Proceed as follows:

1. The transmission must be in PARK (P).
2. Press and hold the brake pedal while pushing the ENGINE START/STOP button once.
3. The READY indicator will appear in the cluster when the vehicle is in Ready to Drive mode.

ENGINE BLOCK HEATER — IF EQUIPPED

The engine block heater warms the engine, and permits quicker starts in cold weather. Connect the cord to a standard 110-115 Volt AC electrical outlet with a grounded, three-wire extension cord.

The engine block heater must be plugged in at least one hour to have an adequate warming effect on the engine.

WARNING!

Remember to disconnect the engine block heater cord before driving. Damage to the 110-115 Volt electrical cord could cause electrocution.

ENGINE BREAK-IN RECOMMENDATIONS

A long break-in period is not required for the engine and drivetrain (transmission and axle) in your vehicle.

Drive moderately during the first 300 miles (500 km). After the initial 60 miles (100 km), speeds up to 50 or 55 mph (80 or 90 km/h) are desirable.

While cruising, brief full-throttle acceleration within the limits of local traffic laws contributes to a good break-in. Wide-open throttle acceleration in low gear can be detrimental and should be avoided.

The engine oil installed in the engine at the factory is a high-quality energy conserving type lubricant. Oil changes should be consistent with anticipated climate conditions under which vehicle operations will occur. For the recommended viscosity and quality grades see  page 265.

CAUTION!

Never use Non-Detergent Oil or Straight Mineral Oil in the engine or damage may result.

NOTE:

A new engine may consume some oil during its first few thousand miles (kilometers) of operation. This should be considered a normal part of the break-in and not interpreted as a problem. Please check your oil level with the engine oil indicator often during the break-in period. Add oil as required.

PARKING BRAKE

ELECTRIC PARK BRAKE (EPB)

Your vehicle is equipped with an EPB that offers simple operation, and some additional features that make the parking brake more convenient and useful.

The parking brake is primarily intended to prevent the vehicle from rolling while parked. Before leaving the vehicle, make sure that the parking brake is applied. Also, be certain to leave the transmission in PARK.

You can engage the parking brake in two ways:

- Manually, by applying the parking brake switch.
- Automatically, by enabling the Auto Park Brake feature in the Customer Programmable Features section of the Uconnect settings.

The parking brake switch is located on the instrument panel to the left of the steering wheel (below the headlamp switch).

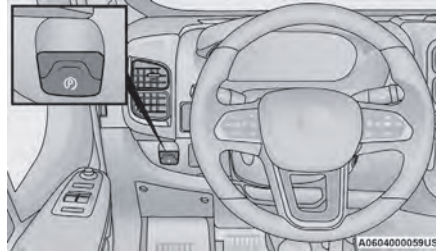

Electric Park Brake Switch

To apply the parking brake manually, pull up on the switch momentarily. You may hear a slight sound from the back of the vehicle while the parking brake engages. Once the park brake is fully engaged, the Brake Warning Light in the instrument cluster and an indicator on the switch will illuminate. If your foot is on the brake pedal while you apply the parking brake, you may notice a small amount of brake pedal movement. The parking brake can be applied even when the ignition switch is OFF but the Brake Warning Light will not illuminate, however, it can only be released when the ignition is in the ON/RUN position.

NOTE:

The EPB Warning Light will illuminate if the EPB switch is held for longer than 20 seconds in either the released or applied position. The light will extinguish upon releasing the switch.

If the Auto Park Brake feature is enabled, the parking brake will automatically engage whenever the transmission is placed into PARK. If your foot is on the brake pedal, you may notice a small amount of brake pedal movement while the parking brake is engaging.

The parking brake will release automatically when the ignition is ON, the transmission is in DRIVE or REVERSE, the driver seat belt is buckled, and an attempt is made to drive away.

To release the parking brake manually, the ignition switch must be in the ON/RUN position. Put your foot on the brake pedal, then push the parking brake switch down momentarily. You may hear a slight whirring sound from the back of the vehicle while the parking brake disengages. You may also notice a small amount of movement in the brake pedal. Once the parking brake is fully disengaged, the Brake Warning Light in the instrument cluster and the LED indicator on the switch will extinguish.

NOTE:

When parking on a hill, it is important to turn the front wheels toward the curb on a downhill grade and away from the curb on an uphill grade. Apply the parking brake before placing the gear selector in PARK, otherwise the load on the transmission locking mechanism may make it difficult to move the gear selector out of PARK.

WARNING!

- Never use the PARK position as a substitute for the parking brake. Always apply the parking brake fully when parked to guard against vehicle movement and possible injury or damage.
- When exiting the vehicle, always take the key fob with you and lock your vehicle.
- Never leave children alone in a vehicle, or with access to an unlocked vehicle. Allowing children to be in a vehicle unattended is dangerous for a number of reasons. A child or others could be seriously or fatally injured. Children should be warned not to touch the parking brake, brake pedal or the gear selector.
- Do not leave the key fob in or near the vehicle, or in a location accessible to children, and do not leave a vehicle equipped with Keyless Enter 'n Go™ in the ACC or ON/RUN position. A child could operate power windows, other controls, or move the vehicle.
- Be sure the parking brake is fully disengaged before driving; failure to do so can lead to brake failure and a collision.

*(Continued)***WARNING!**

- Always fully apply the parking brake when leaving your vehicle, or it may roll and cause damage or injury. Also be certain to leave the transmission in PARK. Failure to do so may allow the vehicle to roll and cause damage or injury.

CAUTION!

If the Brake System Warning Light remains on with the parking brake released, a brake system malfunction is indicated. Have the brake system serviced by an authorized dealer immediately.

If exceptional circumstances should make it necessary to engage the parking brake while the vehicle is in motion, maintain upward pressure on the EPB switch for as long as engagement is desired. The Brake Warning Light will illuminate, and a continuous chime will sound. The rear stop lamps will also be illuminated automatically while the vehicle remains in motion.

To disengage the parking brake while the vehicle is in motion, release the switch. If the vehicle is brought to a complete stop using the parking brake, when the vehicle reaches approximately 3 mph, (5 km/h) the parking brake will remain engaged.

WARNING!

Driving the vehicle with the parking brake engaged, or repeated use of the parking brake to slow the vehicle, may cause serious damage to the brake system. Be

*(Continued)***WARNING!**

sure the parking brake is fully disengaged before driving; failure to do so can lead to brake failure and a collision.

In the unlikely event of a malfunction of the EPB system, a yellow EPB Warning Light will illuminate. This may be accompanied by the Brake Warning Light flashing. In this event, urgent service of the EPB system is required. Do not rely on the parking brake to hold the vehicle stationary.

Auto Park Brake

The Electric Park Brake (EPB) can be programmed to be applied automatically whenever the vehicle is at a standstill and the automatic transmission is placed in PARK. Auto Park Brake is enabled and disabled by customer selection through the Customer Programmable Features section of the Uconnect Settings  page 145.

Any single Auto Park Brake application can be bypassed by pushing the EPB switch to the release position while the transmission is placed in PARK.

SafeHold

SafeHold is a safety feature of the Electric Park Brake (EPB) system that will engage the parking brake automatically if the vehicle is left unsecured while the ignition is in ON/RUN.

The parking brake will automatically engage if all of the following conditions are met:

- The vehicle is at a standstill.
- There is no attempt to press the brake pedal and accelerator pedal.

- The occupant status changed to unoccupied.
- The driver with seatbelt not fastened/unbuckled.

SafeHold can be temporarily bypassed by pushing the EPB switch while the driver door is open. Once manually bypassed, SafeHold will be enabled again once the vehicle reaches 12 mph (20 km/h) or the ignition is turned to the OFF position and back to ON again.

Brake Service Mode

We recommend having your brakes serviced by an authorized dealer. You should only make repairs for which you have the knowledge and the right equipment. You should only enter Brake Service Mode during brake service.

When servicing your rear brakes, it may be necessary for you or your technician to push the rear piston into the rear caliper bore. With the Electric Park Brake (EPB) system, this can only be done after retracting the EPB actuator. Fortunately, actuator retraction can be done easily by entering the Brake Service Mode through the Uconnect Settings in your vehicle. This menu-based system will guide you through the steps necessary to retract the EPB actuator in order to perform rear brake service.

Service Mode has requirements that must be met in order to be activated:

- The vehicle must be at a standstill.
- The parking brake is not applied.
- The transmission must be in PARK or NEUTRAL.
- The brake pedal is not applied.

While in Service Mode, the EPB Warning Light will flash continuously while the ignition is in ON/RUN.

When brake service work is complete, the following steps must be followed to reset the park brake system to normal operation:

- Ensure the vehicle is at a standstill.
- Press the brake pedal with moderate force.
- Apply the EPB Switch.

WARNING!

You can be badly injured working on or around a motor vehicle. Do only that service work for which you have the knowledge and the right equipment. If you have any doubt about your ability to perform a service job, take your vehicle to a competent mechanic.

AUTOMATIC TRANSMISSION

WARNING!

- It is dangerous to shift out of PARK or NEUTRAL if the engine speed is higher than idle speed. If your foot is not firmly pressing the brake pedal, the vehicle could accelerate quickly forward or in reverse. You could lose control of the vehicle and hit someone or something. Only shift into gear when the engine is idling normally and your foot is firmly pressing the brake pedal.
- Unintended movement of a vehicle could injure those in or near the vehicle. As with all vehicles, you should never exit a vehicle while the engine is running. Before exiting a vehicle, always come to a complete stop, then apply the parking brake, shift the transmission into PARK, and turn the ignition

(Continued)

WARNING!

off. When the ignition is in the OFF position, the transmission is locked in PARK, securing the vehicle against unwanted movement.

- When leaving the vehicle, always make sure the ignition is in the OFF position, remove the key fob from the vehicle, and lock the vehicle.
- Never leave children alone in a vehicle, or with access to an unlocked vehicle. Allowing children to be in a vehicle unattended is dangerous for a number of reasons. A child or others could be seriously or fatally injured. Children should be warned not to touch the parking brake, brake pedal or the transmission gear selector.
- Do not leave the key fob in or near the vehicle (or in a location accessible to children), and do not leave the ignition in the ON or RUN position. A child could operate power windows, other controls, or move the vehicle.

CAUTION!

Damage to the transmission may occur if the following precautions are not observed:

- Shift into or out of PARK or REVERSE only after the vehicle has come to a complete stop.
- Do not shift between PARK, REVERSE, NEUTRAL, or DRIVE when the engine is above idle speed.
- Before shifting into any gear, make sure your foot is firmly pressing the brake pedal.

IGNITION PARK INTERLOCK (KEYLESS VEHICLE)

This vehicle is equipped with an Ignition Park Interlock, which requires the transmission to be in PARK before the ignition can be turned to the OFF position. Also, the transmission remains locked in PARK whenever the ignition is in the OFF position.

BRAKE/TRANSMISSION SHIFT INTERLOCK (BTSI) SYSTEM

This vehicle is equipped with a BTSI that holds the transmission gear selector in PARK unless the brakes are applied. To shift the transmission out of PARK, the ignition must be turned to the ON/RUN position (engine running or not), and the brake pedal must be pressed. This vehicle is equipped with an additional lock system that holds the transmission gear selector in NEUTRAL (if vehicle speed is approximately 0 mph (0 km/h)). To lock the transmission gear selector in NEUTRAL, the gear selector must stay in the NEUTRAL position for approximately three seconds. To shift the transmission into REVERSE or DRIVE the brake pedal must be pressed.

NOTE:

Swivel seats that are unlocked can also prevent the transmission gear selector from being moved out of the PARK position. To shift the transmission out of the PARK position the first time after cranking is allowed, ensure swivel seats are locked in the forward facing position.

9-SPEED AUTOMATIC TRANSMISSION

The transmission gear position display (located in the instrument cluster) indicates the transmission gear range. You must press the brake pedal to move the gear selector out of PARK. To drive, move the gear selector from PARK or NEUTRAL to the DRIVE position.

The electronically controlled transmission provides a precise shift schedule. The transmission electronics are self-calibrating; therefore, the first few shifts on a new vehicle may be somewhat abrupt. This is a normal condition, and precision shifts will develop within a few hundred miles (kilometers).

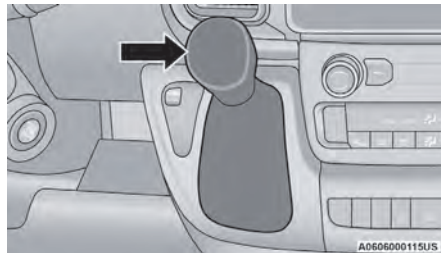

Gear Selector

Only shift from DRIVE to PARK or REVERSE when the accelerator pedal is released and the vehicle is stopped. Be sure to keep your foot on the brake pedal when shifting between these gears.

The transmission gear selector provides PARK, REVERSE, NEUTRAL, DRIVE, and Electronic Range Select (ERS) shift positions. Manual downshifts can be made using the ERS shift control. Moving the gear

selector into the ERS “-”/“+” position (beside the DRIVE position) activates ERS mode, displays the current gear in the instrument cluster, and prevents automatic upshifts beyond this gear. In ERS mode, toggling the gear selector forward “-” or rearward “+” will change the highest available gear → page 94.

NOTE:

If the gear selector cannot be moved to the PARK, REVERSE, or NEUTRAL position (when pushed forward) it is probably in the ERS “+”/“-” position (beside the DRIVE position). In ERS mode, the transmission gear limit (1, 2, 3, etc.) is displayed in the instrument cluster. Move the gear selector to the right (into the DRIVE [D] position) for access to PARK, REVERSE, and NEUTRAL.

Gear Ranges

Do not press the accelerator pedal when shifting out of PARK or NEUTRAL.

NOTE:

After selecting any gear range, wait a moment to allow the selected gear to engage before accelerating. This is especially important when the engine is cold.

PARK (P)

This range supplements the parking brake by locking the transmission. The engine can be started in this range. Never attempt to use PARK while the vehicle is in motion. Apply the parking brake when exiting the vehicle in this range.

When parking on a hill, apply the parking brake before shifting the transmission to PARK, otherwise the load on the transmission locking mechanism may make it

difficult to move the gear selector out of PARK. As an added precaution, turn the front wheels toward the curb on a downhill grade, and away from the curb on an uphill grade.

When exiting the vehicle, always:

- Apply the parking brake.
- Shift the transmission into PARK.
- Turn the engine off.
- Remove the key fob from the vehicle.

WARNING!

- Never use the PARK position as a substitute for the parking brake. Always apply the parking brake fully when exiting the vehicle to guard against vehicle movement and possible injury or damage.
- Your vehicle could move and injure you and others if it is not in PARK. Check by trying to move the transmission gear selector out of PARK with the brake pedal released. Make sure the transmission is in PARK before exiting the vehicle.
- The transmission may not engage PARK if the vehicle is moving. Always bring the vehicle to a complete stop before shifting to PARK, and verify that the transmission gear position indicator solidly indicates PARK (P) without blinking. Ensure that the vehicle is completely stopped, and the PARK position is properly indicated, before exiting the vehicle.
- It is dangerous to shift out of PARK or NEUTRAL if the engine speed is higher than idle speed. If your foot is not firmly pressing the brake pedal, the vehicle could accelerate quickly forward or in reverse. You could lose control of the vehicle and

(Continued)

WARNING!

- hit someone or something. Only shift into gear when the engine is idling normally (or stopped) and your foot is firmly pressing the brake pedal.
- Unintended movement of a vehicle could injure those in or near the vehicle. As with all vehicles, you should never exit a vehicle while the engine is running or the propulsion system is active. Before exiting a vehicle, always come to a complete stop, then apply the parking brake, shift the transmission into PARK, and turn the ignition OFF. When the ignition is in the OFF position, the transmission is locked in PARK, securing the vehicle against unwanted movement.
- When leaving the vehicle, always make sure the ignition is in the OFF position, remove the key fob from the vehicle, and lock the vehicle.
- Never leave children alone in a vehicle, or with access to an unlocked vehicle. Allowing children to be in a vehicle unattended is dangerous for a number of reasons. A child or others could be seriously or fatally injured. Children should be warned not to touch the parking brake, brake pedal or the transmission gear selector.
- Do not leave the key fob in or near the vehicle (or in a location accessible to children), and do not leave the ignition in the ON/RUN position. A child could operate power windows, other controls, or move the vehicle.

The following indicators should be used to ensure that you have engaged the transmission into the PARK position:

- When shifting into PARK, firmly move the gear selector all the way forward and to the left until it stops and is fully seated.
- Look at the transmission gear position display and verify that it indicates the PARK position (P).
- With the brake pedal released, verify that the gear selector will not move out of PARK.

CAUTION!

- Before moving the transmission gear selector out of PARK, you must turn the ignition to the ON/RUN position, and also press the brake pedal. Otherwise, damage to the gear selector could result.
- DO NOT race the engine when shifting from PARK or NEUTRAL into another gear range, as this can damage the drivetrain.

REVERSE (R)

This range is for moving the vehicle backward. Shift into REVERSE only after the vehicle has come to a complete stop.

NEUTRAL (N)

Use this range when the vehicle is standing for prolonged periods with the engine running. The engine may be started in this range. Apply the parking brake and shift the transmission into PARK if you must exit the vehicle.

WARNING!

Do not coast in NEUTRAL and never turn off the ignition to coast down a hill. These are unsafe practices that limit your response to changing traffic or road conditions. You might lose control of the vehicle and have a collision.

CAUTION!

Towing the vehicle, coasting, or driving for any other reason with the transmission in NEUTRAL can cause severe transmission damage.

For Recreational Towing ↪ page 133.

For Towing A Disabled Vehicle ↪ page 209.

DRIVE (D)

This range should be used for most city and highway driving. It provides the smoothest upshifts and downshifts, and the best fuel economy. The transmission automatically upshifts through all forward gears.

When frequent transmission shifting occurs (such as when operating the vehicle under heavy loading conditions, in hilly terrain, traveling into strong head winds, or while towing a heavy trailer), select TOW/HAUL mode or use the Electronic Range Select (ERS) shift control to select a lower gear range ↪ page 94. Under these conditions, using a lower gear range will improve performance and extend transmission life by reducing excessive shifting and heat buildup.

During cold temperatures, transmission operation may be modified depending on engine and transmission temperature as well as vehicle speed. This feature improves warm-up time of the engine and transmission

to achieve maximum efficiency. During extremely cold temperatures (-16°F [-27°C] or below), operation may briefly be limited to THIRD gear only. Normal operation will resume once the transmission temperature has risen to a suitable level.

Transmission Limp Home Mode

Transmission function is monitored electronically for abnormal conditions. If a condition is detected that could result in transmission damage, Transmission Limp Home Mode is activated. In this mode, the transmission remains in THIRD gear regardless of which forward gear is selected. PARK, REVERSE, and NEUTRAL will continue to operate. The Malfunction Indicator Light (MIL) may be illuminated. Transmission Limp Home Mode allows the vehicle to be driven to an authorized dealer for service without damaging the transmission.

In the event of a momentary problem, the transmission can be reset to regain all forward gears by performing the following steps:

1. Stop the vehicle.
2. Shift the transmission into PARK.
3. Turn the ignition OFF.
4. Wait approximately 10 seconds.
5. Restart the engine.
6. Shift into the desired gear range. If the problem is no longer detected, the transmission will return to normal operation.

NOTE:

Even if the transmission can be reset, we recommend that you visit an authorized dealer at your earliest possible convenience. An authorized dealer has diagnostic equipment to assess the condition of your transmission. If the transmission cannot be reset, authorized dealer service is required.

Electronic Range Select (ERS) Operation

The ERS shift control allows the driver to select the max gear limit. For example, if you set the transmission gear limit to FOURTH gear, the transmission will not shift above FOURTH gear, but will shift through the lower gears normally.

You can switch between DRIVE and ERS mode at any vehicle speed. When the gear selector is in the DRIVE position, the transmission will operate automatically, shifting between all available gears. Moving the gear selector to the ERS position (beside DRIVE) will activate ERS mode, display the current gear in the instrument cluster, and set that gear as the max gear limit. Once in ERS mode, moving the gear selector forward “-” or rearward “+” will change the max gear limit.

NOTE:

The transmission will still continue to use the optimal highest gear, for the current driving conditions, within the selected gear range limit.

To exit ERS mode, simply return the gear selector to the DRIVE position.

WARNING!

Do not downshift for additional engine braking on a slippery surface. The drive wheels could lose their grip and the vehicle could skid, causing a collision or personal injury.

NOTE:

To select the proper gear position for maximum deceleration (engine braking), move the gear selector into the ERS position, then tap it forward "-" repeatedly as the vehicle slows. The transmission will shift to the range from which the vehicle can best be slowed down.

When To Use TOW/HAUL Mode

When driving in hilly areas, towing a trailer, carrying a heavy load, etc., and frequent transmission shifting occurs, push the TOW/HAUL switch to activate TOW/HAUL mode. This will improve performance and reduce the potential for transmission overheating or failure due to excessive shifting. When operating in TOW/HAUL mode, transmission upshifts are delayed, and the transmission will automatically downshift (for engine braking) during steady braking maneuvers.

The TOW/HAUL Indicator Light will illuminate in the instrument cluster to indicate that TOW/HAUL mode has been activated. Pushing the switch a second time restores normal operation. Normal operation is always the default at engine start-up. If TOW/HAUL mode is desired, the switch must be pushed each time the engine is started.

**AUTOMATIC TRANSMISSION — BEV
(IF EQUIPPED)**

You must press and hold the brake pedal while shifting out of PARK.

WARNING!

- Never use the PARK position as a substitute for the parking brake. Always apply the parking brake fully when exiting the vehicle to guard against vehicle movement and possible injury or damage.
- Your vehicle could move and injure you and others if it is not in PARK. Check by trying to move the transmission gear selector out of PARK with the brake pedal released. Make sure the transmission is in PARK before exiting the vehicle.
- The transmission may not engage PARK if the vehicle is moving. Always bring the vehicle to a complete stop before shifting to PARK, and verify that the transmission gear position indicator solidly indicates PARK (P) without blinking. Ensure that the vehicle is completely stopped, and the PARK position is properly indicated, before exiting the vehicle.
- It is dangerous to shift out of PARK or NEUTRAL if the engine speed is higher than idle speed. If your foot is not firmly pressing the brake pedal, the vehicle could accelerate quickly forward or in reverse. You could lose control of the vehicle and hit someone or something. Only shift into gear when the engine is idling normally and your foot is firmly pressing the brake pedal.

(Continued)

WARNING!

- Unintended movement of a vehicle could injure those in or near the vehicle. As with all vehicles, you should never exit a vehicle while the engine is running. Before exiting a vehicle, always come to a complete stop, then apply the parking brake, shift the transmission into PARK, and turn the ignition OFF. When the ignition is in the OFF position, the transmission is locked in PARK, securing the vehicle against unwanted movement.
- When exiting the vehicle, always make sure the ignition is in the OFF position, remove the key fob from the vehicle, and lock the vehicle.
- Never leave children alone in a vehicle, or with access to an unlocked vehicle. Allowing children to be in a vehicle unattended is dangerous for a number of reasons. A child or others could be seriously or fatally injured. Children should be warned not to touch the parking brake, brake pedal or the transmission gear selector.
- Do not leave the key fob in or near the vehicle (or in a location accessible to children), and do not leave the ignition in the ACC or ON/RUN position. A child could operate power windows, other controls, or move the vehicle.

CAUTION!

Damage to the transmission may occur if the following precautions are not observed:

- Shift into or out of PARK or REVERSE only after the vehicle has come to a complete stop.
- Do not shift between PARK, REVERSE, NEUTRAL, or DRIVE when the engine is above idle speed.

(Continued)

CAUTION!

- Before shifting into any gear, make sure your foot is firmly pressing the brake pedal.

IGNITION PARK INTERLOCK

Your vehicle is equipped with an Ignition Park Interlock which requires the transmission to be in PARK before the ignition can be turned to the OFF position. This helps the driver avoid inadvertently leaving the vehicle without placing the transmission in PARK. This system also locks the transmission in PARK whenever the ignition is in the OFF position.

BRAKE/TRANSMISSION SHIFT INTERLOCK (BTSI) SYSTEM

Your vehicle is equipped with a BTSI system that holds the transmission gear selector in PARK unless the brakes are applied. To shift the transmission out of PARK, the ignition must be in the ON/RUN position and the brake pedal must be pressed. The brake pedal must also be pressed to shift from NEUTRAL (N) into DRIVE (D) or REVERSE (R) when the vehicle is stopped or moving at low speeds.

BEV TRANSMISSION

The transmission is controlled using a rotary electronic gear selector located on the center console. The transmission gear selector has PARK, REVERSE, NEUTRAL, DRIVE, and LOW shift positions. Using the LOW (L) position will increase the rate of deceleration along with increasing regeneration of power into the vehicle's High Voltage (HV) battery (in comparison to the DRIVE position). The transmission gear range (PRNDL) is displayed

both above the gear selector and in the instrument cluster display. To select a gear range, simply rotate the gear selector. Push down on the gear selector, and then rotate it, to access the L position. You must also press the brake pedal to shift the transmission out of PARK (or NEUTRAL, when the vehicle is stopped). To shift past multiple gear ranges at once (such as PARK to DRIVE), simply rotate the gear selector to the appropriate detent. Select the DRIVE range for normal driving.

NOTE:

In the event of a mismatch between the gear selector position and the actual transmission gear (for example, driver selects PARK while driving), the transmission will shift into NEUTRAL and the position indicator will blink continuously until the selector is returned to the proper position, or the requested shift can be completed.

Only shift from DRIVE to PARK or REVERSE when the accelerator pedal is released and the vehicle is stopped. Be sure to keep your foot on the brake pedal when shifting between these gears.

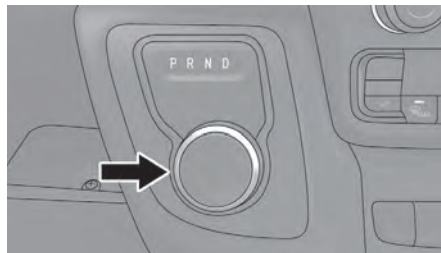

Transmission Gear Selector

GEAR RANGES

Do not press the accelerator pedal when shifting from PARK (P) or NEUTRAL (N) into another gear range.

NEUTRAL (N)

Use this range when the vehicle is standing for prolonged periods with the propulsion system active. The vehicle may be started in this range. Apply the parking brake and shift the transmission into PARK if you must exit the vehicle.

NOTE:

Based on the drive gear and/or speed of the vehicle, the Vehicle Pedestrian Alert Module (VPAM) will broadcast a sound from the rear of the vehicle (if moving in the rearward direction) or from the front (if moving in the forward direction) or from both the front and rear if vehicle direction cannot be determined, to warn nearby pedestrians that a vehicle is approaching. In addition, the module will indicate a change in speed by varying the volume of sound.

WARNING!

Do not coast in NEUTRAL and never turn off the ignition to coast down a hill. These are unsafe practices that limit your response to changing traffic or road conditions. You might lose control of the vehicle and have a collision.

CAUTION!

Towing the vehicle, coasting, or driving for any other reason with the transmission in NEUTRAL can cause severe transmission damage.

For Recreational Towing → page 133.

For Towing A Disabled Vehicle → page 209.

CAUTION!

- Before moving the transmission gear selector out of PARK, you must turn the ignition to the ON/RUN position, and also press the brake pedal. Otherwise, damage to the gear selector could result.
- DO NOT press the accelerator pedal when shifting from PARK or NEUTRAL into another gear range, as this can damage the drivetrain.

PARK (P)

This range supplements the parking brake by locking the transmission. The vehicle propulsion system can be started in this range. Never attempt to use PARK while the vehicle is in motion. Apply the parking brake when exiting the vehicle in this range.

When parking on a hill, apply the parking brake before shifting the transmission to PARK. As an added precaution, turn the front wheels toward the curb on a downhill grade and away from the curb on an uphill grade.

When exiting the vehicle, always:

- Apply the parking brake.
- Shift the transmission into PARK.
- Turn the ignition OFF.
- Remove the key fob from the vehicle.

NOTE:

This vehicle incorporates an Electric Park Brake activation feature which engages automatically when the vehicle is parked on a 9% sloped surface, with the vehicle pointing up the grade or down the grade.

The following indicators should be used to ensure that you have properly engaged the transmission into the PARK position:

- Look at the transmission gear position display and verify that it indicates the PARK position (P), and is not blinking.
- With the brake pedal released, verify that the gear selector will not move out of PARK.

REVERSE (R)

This range is for moving the vehicle backward. Shift into REVERSE only after the vehicle has come to a complete stop.

NOTE:

Based on the drive gear and/or speed of the vehicle, the Vehicle Pedestrian Alert Module (VPAM) will broadcast a sound from the rear of the vehicle to warn nearby pedestrians that a vehicle is approaching. In addition, the module will indicate a change in speed by varying the volume of sound.

POWER STEERING

The electric power steering system will provide increased vehicle response and ease of maneuverability. The power steering system adapts to different driving conditions.

If the steering icon is flashing, it indicates that the vehicle needs to be taken to the dealer for service. It is likely the vehicle has lost power steering assistance.

If the steering icon is displayed and the "POWER STEERING SYSTEM OVER TEMP" message is displayed on the instrument cluster screen, this indicates an over temperature condition in the power steering system. Once driving conditions are safe, pull over and let the vehicle idle for a few moments until the icon and message turn off → page 69.

If the steering icon is displayed and the "SERVICE POWER STEERING - ASSIST OFF" message is displayed on the instrument cluster screen, this indicates the vehicle needs to be taken to the dealer for service → page 69.

NOTE:

- Even if the power steering system is no longer operational, it is still possible to steer the vehicle. Under these conditions there will be a substantial increase in steering effort, especially at low speeds and during parking maneuvers.
- If the condition persists, see an authorized dealer for service.

ACTIVE SPEED LIMITER — IF EQUIPPED

The Active Speed Limiter button is positioned on the right side of the steering wheel.



Active Speed Limiter Button

This feature allows you to program the maximum speed of travel for your vehicle.

NOTE:

The Active Speed Limiter can be set with the vehicle stationary or in motion.

ACTIVATION

To activate the feature, push the Active Speed Limiter button located on the right side of the steering wheel. A message will appear along with an indicator light in the instrument cluster display to signal that Active Speed Limiter has been activated.

After the Active Speed Limiter on/off button has been pushed, you must press the SET (+) or SET (-) button to set the target speed (or RES button when there is already a previously set target).

Push the SET (+) or SET (-) button to raise and lower the target speed to the desired value. Pushing and holding down the SET (+) or SET (-) button will increase/decrease the speed value by increments of 5 mph (5 km/h).

Each time that Active Speed Limiter is activated, it will be set to the last programmed value from the previous activation.

NOTE:

The Cruise Control (if equipped) and Adaptive Cruise Control (if equipped) systems will be unavailable while the Active Speed Limiter is in use.

EXCEEDING THE SET SPEED

By fully pressing the accelerator pedal, the programmed maximum speed can be exceeded while the device is active.

In the event that the Active Speed Limiter set value is exceeded manually with a driver acceleration, an audible indicator will sound. The indicator light will rapidly flash, and a message will appear in the instrument cluster display.

The feature will remain disabled until the vehicle speed drops below the set Active Speed Limiter value, where it will reactivate automatically.

DEACTIVATION

To turn off Active Speed Limiter, push the Active Speed Limiter button on the right side of the steering wheel. A message will appear in the instrument cluster display to confirm that the feature has been turned off. You can also deactivate Active Speed Limiter by pressing the

CANC button. In this case, the system is not completely turned off, and the driver can reactivate the Active Speed Limiter by pressing the RES button.

INTELLIGENT SPEED ASSIST (ISA) — IF EQUIPPED



The Intelligent Speed Assist (ISA) system combines the Active Speed Limiter and Traffic Sign Assist (TSA) systems to automatically adjust the maximum speed of the vehicle based on detected traffic signs.

ACTIVATION

To activate the feature, make sure the Traffic Sign Assist (TSA) system is enabled within Uconnect Settings  page 136, then push the Active Speed Limiter button located on the right side of the steering wheel. The message "Ready" will appear along with a white indicator light in the instrument cluster display to signal that the system has been activated.

While the system is in the "Ready" state, the driver must press the SET (+), SET (-), or RES button to engage the system. When the system is fully engaged and detects the current speed limit using the TSA system, the message in the instrument cluster display will indicate the new detected speed limit by suggesting the driver to press "RES" to accept it.

If the detected speed sign is greater than the current set speed, an up arrow will be displayed too. If the detected speed sign is lower than the current set speed, a down arrow will be displayed instead. If the driver accepts the new suggested speed sign, the indicator light will change to green.

Pushing the SET (+) or SET (-) button on the right of the steering wheel will raise and lower the set speed to a desired value above or below the set ISA speed. Pushing and holding down the SET (+) or SET (-) button will increase/decrease the speed value by increments of 5 mph (5 km/h).

NOTE:

The Cruise Control (if equipped) and Adaptive Cruise Control (if equipped) systems will be unavailable while the ISA system is in use.

EXCEEDING THE SET SPEED

By fully pressing the accelerator pedal, the maximum set speed can be exceeded while the system is active.

When the maximum set speed is exceeded, the green indicator light will blink and the instrument cluster display will show an override message for five seconds, or until the accelerator pedal is released.

DEACTIVATION

To turn off the Intelligent Speed Assist system, push the Active Speed Limiter button on the right side of the steering wheel. A message will appear in the instrument cluster display to confirm that the feature has been turned off. The Intelligent Speed Assist system can also be deactivated by pressing the CANC button. In this case, the ISA system is not completely turned off, and the driver can reactivate the system by pressing the RES button.

CRUISE CONTROL SYSTEMS — IF EQUIPPED

Your vehicle is equipped with the Adaptive Cruise Control (ACC) system which will adjust the vehicle speed up to the preset speed to maintain a distance with the vehicle ahead.

NOTE:

In vehicles **NOT** equipped with the Active Driving Assist (ADA) system:

- Fixed Speed Cruise Control can be used when ACC is not enabled, and functions as normal cruise control.
- Fixed Speed Cruise Control will not detect vehicles directly ahead of you. Always be aware of the feature selected.
- Only one Cruise Control feature can operate at a time. For example, if Fixed Speed Cruise Control is enabled, Adaptive Cruise Control will be unavailable, and vice versa.

ADAPTIVE CRUISE CONTROL (ACC)

Adaptive Cruise Control (ACC) increases the driving convenience provided by Cruise Control while traveling on highways and major roadways. However, it is not a safety system and not designed to prevent collisions.

ACC will allow you to keep Cruise Control engaged in light to moderate traffic conditions without the constant need to reset your speed. ACC utilizes a radar sensor and a forward facing camera designed to detect a vehicle directly ahead of you to maintain a set speed.

NOTE:

- If the ACC sensor detects a vehicle ahead, ACC will apply limited braking or acceleration (not to exceed the original set speed) automatically to maintain a preset following distance, while matching the speed of the vehicle ahead.
- Any chassis/suspension or tire size modifications to the vehicle will affect the performance of the Adaptive Cruise Control and Forward Collision Warning system.
- In vehicles **NOT** equipped with the Active Driving Assist system, Fixed Speed Cruise Control (ACC not enabled) will not detect vehicles directly ahead of you. Always be aware of the feature selected.

4

WARNING!

- Adaptive Cruise Control (ACC) is a convenience system. It is not a substitute for active driver involvement. It is always the driver's responsibility to be attentive of road, traffic, and weather conditions, vehicle speed, distance to the vehicle ahead and, most importantly, brake operation to ensure safe operation of the vehicle under all road conditions. Your complete attention is always required while driving to maintain safe control of your vehicle. Failure to follow these warnings can result in a collision and death or serious personal injury.
- The ACC system:
 - Does not react to pedestrians, oncoming vehicles, and stationary objects (e.g., a stopped vehicle in a traffic jam or a disabled vehicle).

(Continued)

WARNING!

- Cannot take street, traffic, and weather conditions into account, and may be limited upon adverse sight distance conditions.
- Does not always fully recognize complex driving conditions, which can result in wrong or missing distance warnings.
- Will bring your vehicle to a complete stop while following a vehicle ahead and hold your vehicle for approximately three minutes in the stop position. If the vehicle ahead does not start moving within three minutes the parking brake will be activated, and the ACC system will be canceled.

You should not utilize the ACC system:

- When driving in fog, heavy rain, heavy snow, sleet, heavy traffic, and complex driving situations (i.e., in highway construction zones).
- When entering a turn lane or highway off-ramp; when driving on roads that are winding, icy, snow-covered, slippery, or have steep uphill or downhill slopes.
- When towing a trailer up or down steep slopes.
- When circumstances do not allow safe driving at a constant speed.

Adaptive Cruise Control (ACC) Operation

The buttons on the right side of the steering wheel operate the Adaptive Cruise Control system.

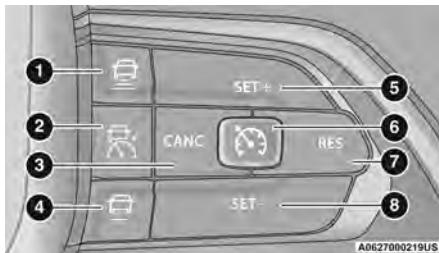

Adaptive Cruise Control Buttons

- 1 — Distance Increase Button
- 2 — Adaptive Cruise Control (ACC) On/Off
- 3 — CANCEL/Cancel
- 4 — Distance Decrease Button
- 5 — SET (+)/Accel
- 6 — Fixed Speed Cruise Control On/Off
- 7 — RES/Resume
- 8 — SET (-)/Decel

Adaptive Cruise Control (ACC) Menu

The instrument cluster display will show the current system settings for Adaptive Cruise Control (ACC), and the Active Driving Assist (ADA) systems. The information it displays depends on ACC, and ADA system statuses.

Push the Adaptive Cruise Control (ACC) on/off button until one of the following appears in the instrument cluster display:

Adaptive Cruise Control Off

When ACC is deactivated, the display will read “Adaptive Cruise Control Off.”

Adaptive Cruise Control Ready

When ACC is activated, but the vehicle speed setting has not been selected, the display will read “Adaptive Cruise Control Ready.”

Adaptive Cruise Control Set

When the SET (+) or the SET (-) button is pushed, the set speed will show in the instrument cluster display.

The ACC screen may display once again if any of the following ACC activity occurs:

- System Cancel
- Driver Override
- System Off
- ACC Proximity Warning
- ACC Unavailable Warning

Adaptive Cruise Control Off

When ACC is deactivated, the display will read “Adaptive Cruise Control Off”.

The instrument cluster display will return to the last display selected after five seconds of no ACC display activity.

Activating Adaptive Cruise Control (ACC)

The minimum set speed for the ACC system is 20 mph (32 km/h).

When the system is turned on and in the ready state, the instrument cluster display will read “ACC Ready.”

When the system is off, the instrument cluster display will read “Adaptive Cruise Control (ACC) Off.”

NOTE:

You cannot engage ACC under the following conditions:

- When the brakes are applied
- When the parking brake is applied

- When the automatic transmission is in PARK, REVERSE or NEUTRAL
- When the vehicle speed is below the minimum speed range
- When the brakes are overheated
- When there is a stationary vehicle in front of your vehicle in close proximity
- When Electronic Stability Control (ESC) Full Off mode is active

To Activate/Deactivate

Push and release the Adaptive Cruise Control (ACC) on/off button. The ACC menu in the instrument cluster display will read "ACC Ready." Then proceed to setting the desired speed as described in the next section.

To turn the system off, push and release the Adaptive Cruise Control (ACC) on/off button again. At this time, the system will turn off and the instrument cluster display will read "Adaptive Cruise Control (ACC) Off." The system will also turn off during any of the conditions listed in "To Turn Off" ⇨ page 102.

WARNING!

Leaving the Adaptive Cruise Control (ACC) system on when not in use is dangerous. You could accidentally set the system or cause it to go faster than you want. You could lose control and have a collision. Always leave the system off when you are not using it.

To Set A Desired Speed

When the vehicle reaches the speed desired, push the SET (+) button or the SET (-) button and release. The instrument cluster display will show the set speed.

NOTE:

Fixed Speed Cruise Control can be used without ACC enabled. To change between the different modes, push the ACC on/off button which turns the ACC and the Fixed Speed Cruise Control off. Pushing the Fixed Speed Cruise Control on/off button will result in turning on (changing to) Fixed Speed Cruise Control mode.

WARNING!

In Fixed Speed Cruise Control mode (ACC not enabled), the system will not react to vehicles ahead. In addition, the proximity warning does not activate and no alarm will sound even if you are too close to the vehicle ahead since neither the presence of the vehicle ahead nor the vehicle-to-vehicle distance is detected. Be sure to maintain a safe distance between your vehicle and the vehicle ahead. Always be aware which mode is selected.

If ACC is set when the vehicle speed is **below** 20 mph (32 km/h), the set speed will default to 20 mph (32 km/h).

NOTE:

Fixed Speed Cruise Control cannot be set below 20 mph (32 km/h).

If either system is set when the vehicle speed is **above** 20 mph (32 km/h), the set speed shall be the current speed of the vehicle.

NOTE:

- Keeping your foot on the accelerator pedal can cause the vehicle to continue to accelerate beyond the set speed. If this occurs, the Adaptive cruise control light will flash and, if a target is detected by the sensor, the target graphics will also flash.
- If you continue to accelerate beyond the set speed while ACC is enabled, the system will not be controlling the distance between your vehicle and the vehicle ahead. The vehicle speed will only be determined by the position of the accelerator pedal.

Desired Driving Speed Through A Detected Speed Sign

The Active Driving Assist (ADA) system allows the driver to set the detected speed sign ⇨ page 106 as the new desired driving speed. The Traffic Sign Assist (TSA) system will suggest the new detected speed sign on the cluster and then the driver can decide to confirm the speed sign capturing by pressing the RES (resume) button.

To Cancel

The following conditions cancel the ACC or Fixed Speed Cruise Control systems:

- The brake pedal is applied
- The CANC (cancel) button is pushed
- The Anti-Lock Brake System (ABS) activates
- The gear selector is removed from the DRIVE position
- The Electronic Stability Control/Traction Control System (ESC/TCS) activates
- The vehicle parking brake is applied

- The braking temperature exceeds normal range (overheated)

To Turn Off

The system will turn off and clear the set speed in memory if:

- The Adaptive Cruise Control (ACC) on/off button is pushed
- The Fixed Speed Cruise Control on/off button is pushed
- The ignition is placed in the OFF position
- The Active Driving Assist (ADA) system (if equipped) is enabled/engaged and the ADA button is pressed

NOTE:

If ADA is not enabled/engaged and the ADA button is pressed, the ACC system will remain on or turn on, depending on the state of ACC at the time of the ADA button press.

To Resume

If there is a set speed in memory, push the RES (resume) button and remove your foot from the accelerator pedal. The instrument cluster display will show the last set speed.

Resume can be used at any speed above 20 mph (32 km/h) when only Fixed Speed Cruise Control is being used.

Resume can be used at any speed above 0 mph (0 km/h) when ACC is active.

NOTE:

- If your vehicle is at standstill longer than two seconds, the driver will either have to push the RES (resume) button, or apply the accelerator pedal to reengage the Adaptive Cruise Control (ACC) to the existing set speed.
- ACC cannot be resumed if there is a stationary vehicle in front of your vehicle in close proximity.

WARNING!

The Resume function should only be used if traffic and road conditions permit. Resuming a set speed that is too high or too low for prevailing traffic and road conditions could cause the vehicle to accelerate or decelerate too sharply for safe operation. Failure to follow these warnings can result in a collision and death or serious personal injury.

To Vary The Speed Setting

To Increase Or Decrease The Set Speed

After setting a speed, you can increase the set speed by pushing the SET (+) button, or decrease speed by pushing the SET (-) button.

U.S. Speed (mph)

- Pushing the SET (+), or SET (-) button once will result in a 1 mph speed adjustment. Each subsequent tap of the button results in an adjustment of 1 mph.
- If the button is held down, the set speed will continue to adjust in 5 mph increments until the button is released. The new set speed is reflected in the instrument cluster display.

Metric Speed (km/h)

- Pushing the SET (+), or SET (-) button once will result in a 1 km/h speed adjustment. Each subsequent tap of the button results in an adjustment of 1 km/h.
- If the button is held down, the set speed will continue to adjust in 10 km/h increments until the button is released. The new set speed is reflected in the instrument cluster display.

NOTE:

When you override and push the SET (+) button or SET (-) button, the new set speed will be the current speed of the vehicle.

When ACC Is Active

- When you use the SET (-) button to decelerate, if the engine's braking power does not slow the vehicle sufficiently to reach the set speed, the brake system will automatically slow the vehicle.
- The ACC system decelerates the vehicle to a full stop when following the vehicle in front. If your vehicle follows the vehicle in front to a standstill, after two seconds the driver will either have to push the RES (resume) button, or apply the accelerator pedal to reengage the ACC to the existing set speed.
- The ACC system maintains set speed when driving uphill and downhill. However, a slight speed change on moderate hills is normal. In addition, downshifting may occur while climbing uphill or descending downhill. This is normal operation and necessary to maintain set speed. When driving uphill and downhill, the ACC system will cancel if the braking temperature exceeds normal range (overheated).

Setting The Following Distance In ACC

The specified following distance for ACC can be set by varying the distance setting between four bars (longest), three bars (medium), two bars (medium) and one bar (short). Using this distance setting and the vehicle speed, ACC calculates and sets the distance to the vehicle ahead. This distance setting will show in the instrument cluster display.

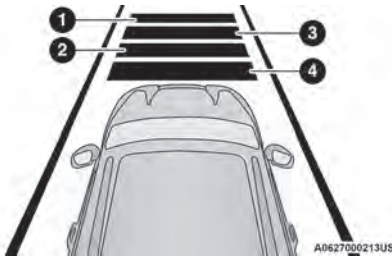

Distance Settings

- 1 — Longest Distance Setting (Four Bars)
- 2 — Medium Distance Setting (Two Bars)
- 3 — Long Distance Setting (Three Bars)
- 4 — Short Distance Setting (One Bar)

To adjust the distance setting, push the Distance Setting Button and release. Each time the button is pushed, the distance setting decreases by one bar (longer). Once the longest setting is reached, if the button is pushed again it will be set to the shortest setting available.

If a slower moving vehicle is detected in the same lane, the instrument cluster display will show the ACC Set With Target Detected Light. The system will then adjust vehicle speed automatically to maintain the distance setting, regardless of the set speed.

The vehicle will then maintain the set distance until:

- The vehicle ahead accelerates to a speed above the set speed.
- The vehicle ahead moves out of your lane or view of the sensor.
- The distance setting is changed.
- The system disengages → page 101.

The maximum braking applied by ACC is limited; however, the driver can always apply the brakes manually, if necessary.

NOTE:

The brake lights will illuminate whenever the ACC system applies the brakes.

A Proximity Warning will alert the driver if ACC predicts that its maximum braking level is not sufficient to maintain the set distance. If this occurs, a visual alert "BRAKE!" will flash in the instrument cluster display and a chime will sound while ACC continues to apply its maximum braking force.

NOTE:

The "BRAKE!" screen in the instrument cluster display is a warning for the driver to take action and does not necessarily mean that the Forward Collision Warning system is applying the brakes autonomously.

Overtake Aid

When driving with Adaptive Cruise Control (ACC) engaged and following a vehicle, the system will provide an additional acceleration up to the ACC set speed to assist in passing the vehicle. This additional acceleration is triggered when the driver utilizes the left turn signal and will only be active when passing on the left hand side.

ACC Operation At Stop

In the event that the ACC system brings your vehicle to a standstill while following a vehicle in front, if the vehicle in front starts moving within two seconds of your vehicle coming to a standstill, your vehicle will resume motion without the need for any driver action.

If the vehicle in front does not start moving within two seconds of your vehicle coming to a standstill, the driver will either have to push the RES (resume) button, or apply the accelerator pedal to reengage the ACC to the existing set speed.

NOTE:

After the ACC system holds your vehicle at a standstill for approximately three consecutive minutes, the parking brake will be activated, and the ACC system will be canceled.

While ACC is holding your vehicle at a standstill, if the driver tries to leave the vehicle, the parking brake will be activated and the ACC system will be canceled.

WARNING!

When the ACC system is resumed, the driver must ensure that there are no pedestrians, vehicles or objects in the path of the vehicle. Failure to follow these warnings can result in a collision and death or serious personal injury.

Display Warnings And Maintenance

RADAR SENSOR UNAVAILABILITY WARNING

The “ACC Front Radar Sensor Temporarily Blinded” warning will display and a chime will sound when conditions temporarily limit system performance.

This most often occurs at times of poor visibility, such as in snow or heavy rain. The ACC system may also become temporarily blinded due to obstructions, such as mud, dirt or ice. In these cases, the instrument cluster display will display this warning message and the system will deactivate.

This message can sometimes be displayed while driving in highly reflective areas (i.e. ice and snow, or tunnels with reflective tiles). The ACC system will recover after the vehicle has left these areas. Under rare conditions, when the radar is not tracking any vehicles or objects in its path this warning may temporarily occur.

NOTE:

If the “ACC Front Radar Sensor Temporarily Blinded” warning is active, Fixed Speed Cruise Control can be still enabled.

If weather conditions are not a factor, the driver should examine the sensor. It may require cleaning or removal of an obstruction. The sensor is located in the center of the vehicle behind the lower grille.

To keep the ACC system operating properly, it is important to note the following maintenance items:

- Always keep the sensor clean. Carefully wipe the sensor lens with a soft cloth. Be cautious not to damage the sensor lens.
- Do not remove any screws from the sensor. Doing so could cause an ACC system malfunction or failure and require a sensor realignment.
- If the sensor or front end of the vehicle is damaged due to a collision, see an authorized dealer for service.
- Do not attach or install any accessories near the sensor, including transparent material or aftermarket grilles. Doing so could cause an ACC system failure or malfunction.

When the condition that deactivated the system is no longer present, the system will return to the “Adaptive Cruise Control Off” state and will resume function by simply reactivating it.

NOTE:

- If the “ACC Front Radar Sensor Temporarily Blinded” message occurs frequently (e.g. more than once on every trip) without any snow, rain, mud, or other obstructions, have the radar sensor realigned at an authorized dealer.
- Installing a snowplow, front-end protector, an aftermarket grille or modifying the grille is not recommended. Doing so may block the sensor and inhibit ACC operation.

“ACC LIMITED FUNCTIONALITY CAMERA BLOCKED” WARNING

The “ACC Limited Functionality Camera Blocked” warning will display and a chime will sound when conditions temporarily limit system performance. This most often occurs at times of poor visibility, such as in snow, low sun, heavy rain, or fog. The ACC system may also become temporarily blinded due to obstructions, such as mud, dirt, or ice on windshield and fog on the inside of glass. In these cases, the instrument cluster display will read “ACC Limited Functionality Camera Blocked” and the system will have degraded performance.

This message can sometimes be displayed while driving in adverse weather conditions. The ACC system will recover after the vehicle has left these areas. Under rare conditions, when the camera is not tracking any vehicles or objects in its path this warning may temporarily occur.

If weather conditions are not a factor, the driver should examine the windshield and clean it if it’s dirty.

When the condition that created limited functionality is no longer present, the system will return to full functionality.

NOTE:

If the “ACC Limited Functionality Camera Blocked” message occurs frequently (e.g. more than once on every trip) without any low sun, snow, rain, mud, or other obstructions, have the windshield and forward facing camera inspected at an authorized dealer.

SERVICE ACC WARNING

If the system turns off, and the instrument cluster display reads “ACC Unavailable Service Required” or “Cruise Unavailable Service Required”, there may be an internal system fault or a temporary malfunction that

limits ACC functionality. Although the vehicle is still drivable under normal conditions, ACC will be temporarily unavailable. If this occurs, try activating ACC again later, following an ignition cycle. If the problem persists, see an authorized dealer.

Precautions While Driving With ACC

In certain driving situations, ACC may have detection issues. In these cases, ACC may brake late or unexpectedly. The driver needs to stay alert and may need to intervene. The following are examples of these types of situations:

TOWING A TRAILER

Towing a trailer is not recommended when using ACC.

OFFSET DRIVING

ACC may not detect a vehicle in the same lane that is offset from your direct line of travel, or a vehicle merging in from a side lane. There may not be sufficient distance to the vehicle ahead. The offset vehicle may move in and out of the line of travel, which can cause your vehicle to brake or accelerate unexpectedly.

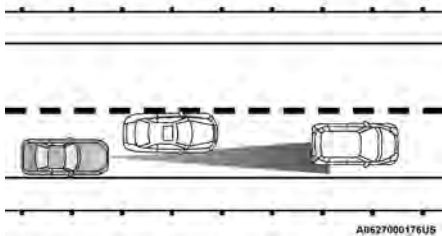

Offset Driving Condition Example

URNS AND BENDS

When driving on a curve with ACC engaged, the system may increase or decrease the vehicle speed for stability, with no vehicle ahead detected. Once the vehicle is out of the curve, the system will resume your original set speed. This is a part of normal ACC system functionality.

NOTE:

On tight turns ACC performance may be limited.

USING ACC ON HILLS

ACC performance may be limited when driving on hills. ACC may not detect a vehicle in your lane depending on the speed, vehicle load, traffic conditions, and the steepness of the hill.



ACC Hill Example

LANE CHANGING

ACC may not detect a vehicle until it is completely in the lane in which you are traveling. In the following lane changing example, ACC has not yet detected the vehicle changing lanes and it may not detect the vehicle until it's too late for the ACC system to take action. ACC may not detect a vehicle until it is completely in the lane.

There may not be sufficient distance to the lane-changing vehicle. Always be attentive and ready to apply the brakes if necessary.

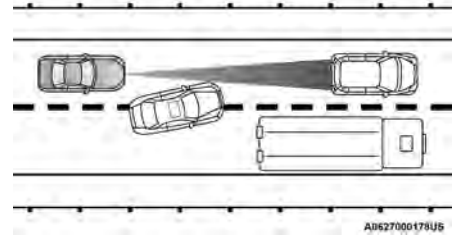

Lane Changing Example

NARROW VEHICLES

Some narrow vehicles traveling near the outer edges of the lane or edging into the lane are not detected until they have moved fully into the lane. There may not be sufficient distance to the vehicle ahead.

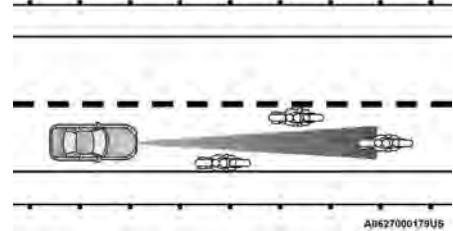

Narrow Vehicle Example

STATIONARY OBJECTS AND VEHICLES

ACC does not react to stationary objects or vehicles. For example, ACC will not react in situations where the vehicle you are following exits your lane and the vehicle ahead is stopped in your lane. It will consider this stopped vehicle a stationary object as it did not previously detect movement from it. Always be attentive and ready to apply the brakes if necessary.

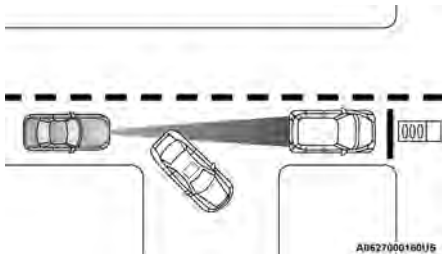

Stationary Object And Stationary Vehicle Example

TRAFFIC SIGN ASSIST SYSTEM — IF EQUIPPED

The Traffic Sign Assist (TSA) system uses a camera mounted on the windshield, as well as map data when the vehicle is equipped with Navigation, to detect recognizable road signs such as:

- Speed limits
- School zones
- No passing zones

NOTE:

- The TSA system will automatically display the road sign detected in the unit of measurement (mph or km/h) selected within Uconnect Settings or within the instrument cluster display.
- If no speed limit signs are detected, the system will revert to the speed limit signs that are stored in the Navigation system.
- The system always checks the traffic signs indicating the current speed limit signs. The system is able to recognize and display up to two different road signs in the instrument cluster display.

ACTIVATION/DEACTIVATION

The TSA System can be enabled/disabled within the Uconnect system through the Safety/Driver Assistance menu. System ON is signaled by road signs shown on the instrument cluster display.

NOTE:

Even if the system is OFF, the speed limit sign will be displayed when the driver selects it in the HOME screen.

TRAFFIC SIGN ASSIST MODES

TSA has three selectable modes of operation that are available through the Uconnect system.

Visual

When Visual is selected, the system will alert the driver when the current speed of the vehicle exceeds the detected speed limit by showing a graphic in the instrument cluster display.

Visual + Chime

When Visual + Chime is selected, the system will alert the driver when the current speed of the vehicle exceeds the detected speed limit by showing a graphic in the instrument cluster display, and by sounding an audible alert. The audible alert will last for 10 seconds, and the visual alert will remain on as long as the vehicle is exceeding the speed limit.

TSA Off

When the TSA system is turned off, the system will not show any traffic signs (unless selected in the HOME screen, which will show detected speed limit signs), and no alerts will be issued to the driver.

INDICATIONS ON THE DISPLAY

Detected traffic signs are shown in the instrument cluster display, and can display any combination of signs at one time (e.g. speed limit, speed limit and supplemental info, and "Do Not Pass" signs) depending on what information is available.

When a newly detected speed limit is higher than the current speed limit, the display will update along with an up arrow.

When a newly detected speed limit is lower than the current speed limit, the display will update along with a down arrow.

NOTE:

Up or down arrows will be displayed for up to five seconds.

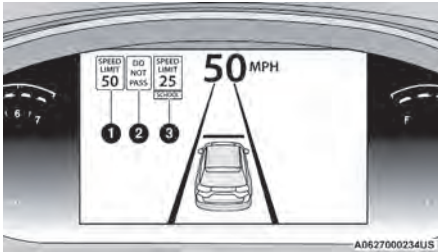

Traffic Signs Recognized

- 1 — Current Speed Limit
- 2 — No Passing Zone Detected
- 3 — Next Speed Limit Detected With Supplemental Information (School Zone)

Supplemental Information

Supplemental information may be displayed along with a newly detected speed limit indicating special circumstances the driver should be aware of. Available supplemental information includes:

- School
- Construction
- Rain
- Snow
- Fog

Speed Limit Exceeded

When the vehicle's speed exceeds the displayed speed limit by 3 mph (5 km/h), the speed limit sign on the instrument cluster display will show a red outline to alert the driver.

WARNING!

Active Driving Assist is an SAE Level 2 Driver Assist feature, requiring driver attention at all times. To prevent serious injury or death:

- Always remember that the Active Driver Assist system is a convenience system that cannot accurately detect all situations. Complete attention is always required while driving even when using ADA.
- Always remain alert and be ready to take control of the vehicle in the event that the Active Driving Assist system disables.
- Always keep your hands on the steering wheel when the Active Driving Assist system is activated, deactivated, or otherwise lacks full functionality as described in this section.
- Do not use a hand-held device when the Active Driving Assist system is engaged.
- Maintain a safe distance from other vehicles and pay attention to traffic conditions.
- Do not place any objects on the steering wheel (e.g. steering wheel covers) which could interfere with the hand detection sensors.
- Always pay attention to the road when using the Active Driving Assist system. ADA will not steer to avoid safety hazards, construction zones, objects, or roadway impediments. You need to maintain control to steer and brake the vehicle in such situations and when merging into traffic, entering the highway, making a turn for crossing traffic, or stopping for traffic control devices.

ACTIVE DRIVING ASSIST SYSTEM — IF EQUIPPED

OPERATION

The Active Driving Assist (ADA) system is combined with the Adaptive Cruise Control (ACC) system, and centers the vehicle in the driving lane while traveling at speeds up to 93 mph (150 km/h).

For ACC system operating instructions and system limitations, see [page 99](#).

NOTE:

- The driver should always obey traffic laws and speed limits. Never drive above applicable speed limit restrictions.
- The driver can override ADA at any time by braking, accelerating, or steering the vehicle.

Just like ACC, ADA will maintain a set speed as long as the set distance between your vehicle and the vehicle in front is maintained. ADA will also keep your vehicle centered between the lane lines, and monitor for other vehicles in adjacent lanes by utilizing the Blind Spot Monitoring sensors.

ADA uses sensors within the steering wheel to monitor driver attentiveness. ADA requires the driver's hands on the steering wheel at all times.

The system will generally aim to keep the vehicle centered in the lane, but when the driver turns the steering wheel (e.g. to move farther away from a large vehicle in the next lane) the system will reduce its control and enter "co-steering" mode. While in co-steering mode, the system will provide reduced assistance and allow the driver to control the path of the vehicle. Once the

driver stops providing input to the steering wheel, the system will require a few seconds to fully resume lane centering assistance, especially during curves.

WARNING!

The Active Driving Assist (ADA) system is a convenience system. It is not a substitute for active driver involvement. It is always the driver's responsibility to be attentive of road traffic, weather conditions, vehicle speed, distance to the vehicle ahead, position in the lane compared to other vehicles, and brake operation to ensure safe operation of the vehicle under all road conditions. Your complete attention is always required while driving to maintain safe control of your vehicle. Failure to follow these warnings can result in a collision and death or serious personal injury.

You should not utilize the ADA system:

- When driving in complex driving situations (e.g. urban environments, construction zones, etc.), adverse weather or low visibility conditions (e.g. rain, snow, fog, sleet, dust), or adverse road conditions (e.g. heavy traffic, worn or missing lane markings, etc.).
- When entering a highway on-ramp or exiting an off-ramp, when driving on roads that are icy, snow covered, or slippery.
- When circumstances do not allow safe driving at a constant speed.

TURNING ACTIVE DRIVING ASSIST ON OR OFF

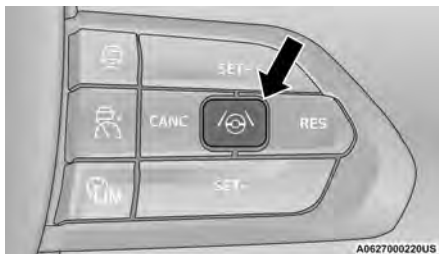

Active Driving Assist On/ Off Button

To enable the Active Driving Assist system, proceed as follows:

1. Push the Active Driving Assist on/off button located on the right side of the steering wheel. The steering wheel image will display white in the instrument cluster display until the system is engaged. If ACC was previously turned off, pushing this button will activate just the lane centering feature of the ADA system. Push the ACC button to activate both ACC and ADA Systems.
2. If ACC was active and engaged before pushing the ADA on/off button, ACC will remain engaged and ADA will become enabled and then engaged (once all other conditions are met).
3. If ACC was not enabled before pushing the ADA on/off button, push the SET (+) button or the SET (-) button and release when the desired driving speed is shown in the instrument cluster display.

4. If desired, adjust the ACC distance setting by pushing the Distance Setting button.

When all system conditions are met as described in "System Engagement Conditions" in the next section, the system will engage and the steering wheel image in the display will change to green.

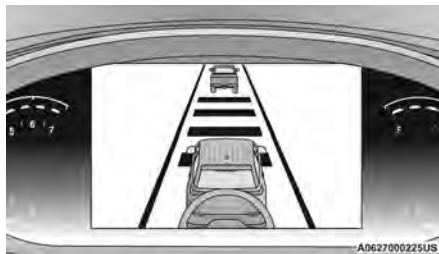

Active Driving Assist Engaged (Steering Wheel Green)

NOTE:

Along with the color change of the steering wheel image, the glow effect of the instrument cluster display will also change to green when ADA is engaged.

System Engagement Conditions

The following conditions must be met before the system will engage:

- Active Driving Assist system is enabled
- ACC is active
- Driver seat belt is buckled
- System detects visible lane markings
- Vehicle is traveling below 93 mph (150 km/h)
- Vehicle is centered in lane
- Turn signal is not activated

- Vehicle is not in a tight curve
- Driver has hands on steering wheel

NOTE:

- The driver should always obey traffic laws and speed limits. Never drive above applicable speed limit restrictions.
- The driver can override ADA at any time by braking, accelerating, or steering the vehicle.
- For the system to detect the driver's hands on the steering wheel, the wheel must be gripped on the outside. Gripping the inside areas of the steering wheel will not satisfy the hands-on condition to engage the system.



Do Not Grip Inside Of Steering Wheel

System Deactivation

The system will be deactivated in any of the following situations:

- If the system has detected driver inattentiveness, and has gone through all escalation warnings after hands are no longer detected on the steering wheel
- If lane markings are no longer detected
- If the brake pedal is pressed or ACC system is deactivated
- If the Active Driving Assist on/off button is pushed again (ADA will turn off)
- If a turn signal is used (unless a target is in the blind spot zone on the same side the turn signal is being applied)
- If the driver applies enough input to the steering wheel
- If the driver's seat belt is released
- If the vehicle speed exceeds 93 mph (150 km/h)
- If the Forward Collision Warning (FCW) system becomes active and is providing warnings/braking
- Pushing the Active Driving Assist on/off button will turn the system off. All other deactivation conditions will place the system back into the "enabled" state with the steering wheel indicator displayed in white until all engagement conditions are met again.
- When the system is deactivated, the system status indicator lights will turn off, Active Lane Management will return to its previous state, and ACC will disable.
- Active Driving Assist Indicator (steering wheel icon in the instrument cluster display)
- Glow effect of the instrument cluster display

If driver attention is not returned, the system will deactivate.

Active Driving Assist Indicators Are Off

- ADA is not turned on/enabled by the driver.

Active Driving Assist Indicators Are White

- ADA is turned on/enabled by the driver, but the system is not actively providing steering to the vehicle.

Active Driving Assist Indicators Are Green

- The system detects driver is attentive and is actively steering the vehicle.

Active Driving Assist Indicators Are Yellow

- Driver inattentiveness has been detected, warning the driver to place hands on the steering wheel.

Active Driving Assist Indicators Are Red

- Driver inattentiveness is still being detected, warning the driver to place hands on the steering wheel. This warning is also issued when the system has detected a tight curve and is warning the driver to take control

NOTE:

The driver **MUST** replace hands on the steering wheel and take control of the vehicle when the system is deactivated.

INDICATIONS ON THE DISPLAY

The Active Driving Assist system status can always be viewed in the instrument cluster display, and status changes are shown by changes in color of the system's indicator lights.

As the system detects driver inattentiveness as previously described ↪ page 107, the system status indicator lights will change from green, to yellow, to red, while the steering wheel icon on the display moves up the screen to the center. The following indicators will change in color as warnings to the driver escalate:

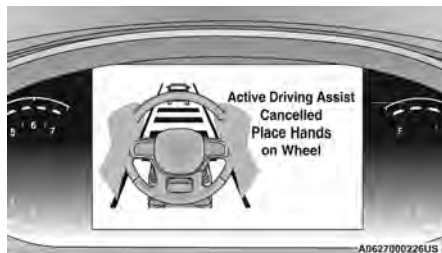

Active Driving Assist Cancelled Message

MINIMUM RISK MANEUVER

If the driver's hands are removed from the steering wheel, a counter will start in order to display and activate visual and acoustic alerts. When the absence of hands is detected, the system will start Minimum Risk Maneuver for bringing the vehicle in a safe position.

After 23 seconds from the absence of the hands on the steering wheel, the Adaptive Cruise Control (ACC) system will apply a brake jerk to warn the driver to take vehicle control. If, after another 3 seconds the driver does not take the control of the vehicle, the system will apply a second brake jerk.

Subsequently, if the absence of hands on the steering wheel persists, the system will apply an automatic braking intervention to bring the vehicle to the stop. As soon as the standstill condition is reached, the hazard emergency lights will be activated. Then, the system will unlock the doors (if previously locked). If the driver takes control of the vehicle during the Minimum Risk

Maneuver by placing the hands on the steering wheel or pressing the pedal throttle, the system will behave normally and the Minimum Risk Maneuver will be stopped.

SYSTEM STATUS

Along with changes in the system's indicator lights (green, yellow, and red), the system can also issue a steering wheel vibration to accompany these warnings. The vibration warning (if enabled) will occur if the vehicle crosses a lane marker, for example, when driving on a tight curve. This feature can be turned on or off within the Uconnect system → page 136.

SYSTEM OPERATION/LIMITATIONS

WARNING!

Active Driving Assist is an SAE Level 2 Driver Assist feature, requiring driver attention at all times. To prevent serious injury or death:

- Always remember that the Active Driver Assist system is a convenience system that cannot accurately detect all situations. Complete attention is always required while driving even when using ADA.
- Always remain alert and be ready to take control of the vehicle in the event that the Active Driving Assist system disables.
- Always keep your hands on the steering wheel when the Active Driving Assist system is activated, deactivated, or otherwise lacks full functionality as described in this section.

(Continued)

WARNING!

- Do not use a hand-held device when the Active Driving Assist system is engaged.
- Maintain a safe distance from other vehicles and pay attention to traffic conditions.
- Do not place any objects on the steering wheel (e.g. steering wheel covers) which could interfere with the hand detection sensors.
- Always pay attention to the road when using the Active Driving Assist system. ADA will not steer to avoid safety hazards, construction zones, objects, or roadway impediments. You need to maintain control to steer and brake the vehicle in such situations and when merging into traffic, entering the highway, making a turn for crossing traffic, or stopping for traffic control devices.

The Active Driving Assist system **DOES NOT**:

- Warn or prevent collisions with other vehicles
- Steer your vehicle around stopped vehicles, slower vehicles, construction equipment, pedestrians, or animals
- Respond to traffic lights or stop signs
- Merge onto highways or exit off ramps
- Turn your vehicle
- Change lanes
- React to cross traffic

NOTE:

Adaptive Cruise Control (ACC) is a core component of ADA. For ACC system limitations → page 99.

The Active Driving Assist system may have limited or reduced functionality when one of the following conditions occur:

- The vehicle's radar sensors and/or forward facing camera is damaged, covered, misaligned, obstructed (e.g. by mud, ice, snow, etc.), or works in low sun conditions
- If the suspension alignment is not correct, if the vehicle is modified (e.g. lifting or lowering the suspension, installing different sized wheels or tires)
- Driving near highway toll booths

NOTE:

If damage to the windshield occurs, have the windshield replaced by an authorized dealer as soon as possible.

PARKSENSE FRONT/REAR PARK ASSIST — IF EQUIPPED

The ParkSense Park Assist system provides visual and audible indications of the distance between the rear, and if equipped, the front fascia/bumper and a detected obstacle when backing up or moving forward (e.g. during a parking maneuver). For limitations of the system (e.g. during a parking maneuver), see [↗ page 114](#).

NOTE:

- The system is designed to assist the driver and not to substitute the driver.
- The driver must stay in full control of the vehicle's acceleration and braking and is responsible for controlling the vehicle's movements.

ParkSense will retain the last system state (enabled or disabled) from the last ignition cycle when the ignition is placed in the ON/RUN position.

ParkSense is active when the gear selector is shifted to REVERSE or to a forward gear and an obstacle is detected, as long as the system is on. When the gear selector shifted to NEUTRAL or PARK, the system becomes inactive. When the vehicle is moving forward, the system will remain active until the vehicle speed remains below approximately 8 mph (13 km/h). Reducing the speed approximately below 7 mph (11 km/h), the system will come back active. When the vehicle is moving in REVERSE, the system will remain active as long as the vehicle speed remains below the maximum operating speed of 7 mph (11 km/h). When the maximum speed limit is exceeded, the system is disabled and the ParkSense switch LED will illuminate. The system will become active again if the vehicle speed reduces below approximately 6 mph (9 km/h).

Interaction With Trailer Towing

The Park Assist system is automatically deactivated when a trailer is hitched to the vehicle. The system will be automatically activated as soon as the trailer is removed.

PARKSENSE SENSORS

The six ParkSense sensors (four when vehicle is not equipped with front sensors), located in the rear fascia/bumper, and the six ParkSense sensors located in the front fascia/bumper, monitor the area in front and behind the vehicle that is within the sensors' field of view. The front sensors detect obstacles from approximately 12 inches (30 cm) up to 39 inches (100 cm) from the front fascia/bumper. The rear sensors can detect obstacles from approximately 12 inches (30 cm) up to 55 inches (140 cm) from the center of the rear

fascia/bumper and up to 24 inches (60 cm) from the corners of the rear fascia/bumper. These distances depend on the location, type and orientation of the obstacle in the horizontal direction.

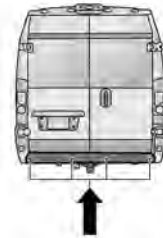

A062000177US

Rear Park Assist Sensors Location

If several obstacles are detected, the ParkSense system indicates the nearest obstacle.

The minimum height of a detectable obstacle corresponds to the maximum height of an obstacle that would clear the underside of the vehicle during the parking maneuver.

PARKSENSE WARNING DISPLAY

The ParkSense Warning screen will only be displayed if "Sound and Display" is selected in the Uconnect system [↗ page 136](#).

The ParkSense Warning screen is located within the instrument cluster display [↗ page 69](#). It provides visual warnings to indicate the distance between the rear fascia/bumper and/or front fascia/bumper and the detected obstacle.

PARKSENSE DISPLAY

The warning display will turn on indicating the system status when the vehicle is in REVERSE or when the vehicle is in DRIVE and an obstacle has been detected.

The system will indicate a detected obstacle by showing a single arc in the left and/or right front or rear regions based on the object's distance and location relative to the vehicle.

If an object is detected in the left and/or right rear region, the display will show a single arc in the left

and/or right rear region and the system will produce a tone. As the vehicle moves closer to the object, the display will show the single arc moving closer to the vehicle and the tone will change from a single 1/2 second tone to slow, to fast, to continuous.

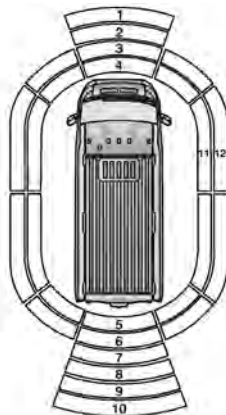

A0629000274US

Front & Rear ParkSense Arcs

- 1 – No Tone/Solid Arc
- 2 – No Tone/Flashing Arc
- 3 – Fast Tone/Flashing Arc
- 4 – Continuous Tone/Flashing Arc
- 5 – Continuous Tone/Flashing Arc
- 6 – Fast Tone/Flashing Arc

- 7 – Fast Tone/Flashing Arc
- 8 – Slow Tone/Solid Arc
- 9 – Slow Tone/Solid Arc
- 10 – Single 1/2 Second Tone/Solid Arc
- 11 – Continuous Tone/Flashing Arcs
- 12 – Fast Tone/Flashing Arcs

The vehicle is close to the obstacle when the instrument cluster display shows one flashing arc and sounds a continuous tone. The following chart shows the warning alert operation when the system is detecting an obstacle:

WARNING ALERTS FOR REAR							
Rear Distance (inches/cm)	Greater than 59 inches (150 cm)	59-52 inches (150-130 cm)	52-41 inches (130-105 cm)	41-34 inches (105-85 cm)	34-24 inches (85-60 cm)	24-12 inches (60-30 cm)	Less than 12 inches (30 cm)
Arcs – Left	None	None	None	None	None	6th Flashing	5th Flashing
Arcs – Center	None	10th Solid	9th Solid	8th Solid	7th Flashing	6th Flashing	5th Flashing
Arcs – Right	None	None	None	None	None	6th Flashing	5th Flashing
Audible Alert Chime	None	Audible chime increases as the object gets closer to the vehicle					Continuous
Radio Volume Reduced	No	Yes					

4

WARNING ALERTS FOR FRONT					
Front Distance (inches/cm)	Greater than 39 inches (100 cm)	39-32 inches (100-80 cm)	32-24 inches (80-60 cm)	24-12 inches (60-30 cm)	Less than 12 inches (30 cm)
Arcs – Left	None	None	None	3rd Flashing	4th Flashing
Arcs – Center	None	1st Solid	2nd Flashing	3rd Flashing	4th Flashing
Arcs – Right	None	None	None	3rd Flashing	4th Flashing
Audible Alert Chime	None	Audible chime increases as the object gets close to the vehicle			Continuous
Radio Volume Reduced	No	Yes	Yes	Yes	

NOTE:

ParkSense will reduce the volume of the radio, if on, when the system is sounding an audible tone.

Front Park Assist Audible Alerts

ParkSense will turn off the Front Park Assist audible alert (chime) after approximately three seconds when an obstacle has been detected, the vehicle is stationary, and brake pedal is applied.

Adjustable Chime Volume Settings

Front and Rear chime volume settings can be selected from the Uconnect system ↪ page 136.

The chime volume settings include low, medium, and high.

ParkSense will retain its last known configuration state through ignition cycles.

ENABLING AND DISABLING PARKSENSE

ParkSense can be enabled and disabled with the ParkSense switch, located on the switch panel below the Uconnect display.

When the ParkSense switch is pushed to disable the system, the instrument cluster display ↪ page 69 will show the "ParkSense Disabled" message for approximately five seconds.

The ParkSense switch LED will be on when ParkSense is disabled or requires service. The ParkSense switch LED will be off when the system is enabled. If the ParkSense switch is pushed, and requires service, the ParkSense switch LED will blink momentarily, and then the LED will be on.

SERVICE THE PARKSENSE PARK ASSIST SYSTEM

When the ParkSense System has detected a faulted condition, the instrument cluster display will actuate a single chime, and it will show the "PARKSENSE UNAVAILABLE WIPE REAR SENSORS", "PARKSENSE UNAVAILABLE WIPE FRONT SENSORS", or the "PARKSENSE UNAVAILABLE SERVICE REQUIRED" message for five seconds. Under this condition, ParkSense will not operate.

If "PARKSENSE UNAVAILABLE WIPE REAR SENSORS" or "PARKSENSE UNAVAILABLE WIPE FRONT SENSORS" appears in the instrument cluster display make sure the outer surface and the underside of the rear fascia/bumper and/or front fascia/bumper is clean and clear of snow, ice, mud, dirt or other obstruction and then cycle the ignition. If the message continues to appear, see an authorized dealer.

If the "PARKSENSE UNAVAILABLE SERVICE REQUIRED" message appears in the instrument cluster display, see an authorized dealer.

PARKSENSE PARK ASSIST FAILURE INDICATIONS

A malfunction of the ParkSense sensors or system is indicated, during REVERSE gear engagement, by the instrument panel warning icon.

The warning icon is illuminated and a message is displayed in the instrument cluster display (if equipped) ↪ page 77.

The sensors and wiring are tested continuously when the ignition is in the ON/RUN position. Failures are indicated immediately if they occur when the system is on.

Even if the system is able to identify that a specific sensor is in failure condition, the instrument cluster display shall indicate that the ParkSense system is unavailable, without reference to the sensor in failure condition. If even a single sensor fails, the entire system must be disabled. The system is turned off automatically.

CLEANING THE PARKSENSE SYSTEM

Clean the ParkSense sensors with water, car wash soap and a soft cloth. Do not use rough or hard cloths. Do not scratch or poke the sensors. Otherwise, you could damage the sensors.

PARKSENSE PARK ASSIST SYSTEM USAGE PRECAUTIONS**NOTE:**

- Ensure that the front and rear fascia/bumper are free of snow, ice, mud, dirt and debris to keep the ParkSense system operating properly.
- Construction equipment, large trucks, and other vibrations could affect the performance of ParkSense.
- When you turn ParkSense off, the instrument cluster display will read "PARKSENSE OFF." Furthermore, once you turn ParkSense off, it remains off until you turn it on again, even if you cycle the ignition key.
- ParkSense, when on, will reduce the volume of the radio when it is sounding a tone.

- Clean the ParkSense sensors regularly, taking care not to scratch or damage them. The sensors must not be covered with ice, snow, slush, mud, dirt or debris. Failure to do so can result in the system not working properly. The ParkSense system might not detect an obstacle behind or in front of the fascia/bumper, or it could provide a false indication that an obstacle is behind or in front of the fascia/bumper.
- Use the ParkSense switch to turn the ParkSense system and Side Distance Warning off if objects such as bicycle carriers, etc. are placed within 12 inches (30 cm) from the rear fascia/bumper. Failure to do so can result in the system misinterpreting a close object as a sensor problem, causing the “PARKSENSE UNAVAILABLE SERVICE REQUIRED” message to be displayed in the instrument cluster display.

NOTE:

If any objects are attached to the bumper within a 6.5 ft (2 m) field of view, they will interfere and cause false alerts and possibly blockage.

- There may be a delay in the object detection rate if the object is moving.
- The operation of the rear sensors is automatically deactivated when the trailer's electric plug is inserted in the vehicle's tow hook socket, while the front sensors stay active and can provide acoustic and visual warnings. The rear sensors are automatically reactivated when the trailer's cable plug is removed.

WARNING!

- Drivers must be careful when backing up even when using ParkSense. Always check carefully behind your vehicle, look behind you, and be sure to check for pedestrians, animals, other vehicles, obstructions, and blind spots before backing up. You are responsible for safety and must continue to pay attention to your surroundings. Failure to do so can result in serious injury or death.
- Before using ParkSense, it is strongly recommended that the ball mount and hitch ball assembly be disconnected from the vehicle when the vehicle is not used for towing. Failure to do so can result in injury or damage to vehicles or obstacles because the hitch ball will be much closer to the obstacle than the rear fascia when the vehicle sounds the continuous tone. Also, the sensors could detect the ball mount and hitch ball assembly, depending on its size and shape, giving a false indication that an obstacle is behind the vehicle.

CAUTION!

- ParkSense is only a parking aid and it is unable to recognize every obstacle, including small obstacles. Parking curbs might be temporarily detected or not detected at all. Obstacles located above or below the sensors will not be detected when they are in close proximity.
- The vehicle must be driven slowly when using ParkSense in order to be able to stop in time when an obstacle is detected. It is recommended that the driver looks over his/her shoulder when using ParkSense.

If it is necessary to keep the ball mount and hitch ball assembly mounted for a long period, it is possible to filter out the ball mount and hitch ball assembly presence in the sensor field of view. The filtering operation must be performed only by an authorized dealer.

SIDE DISTANCE WARNING SYSTEM

The Side Distance Warning system detects the presence of side obstacles near the vehicle using the parking sensors located in the front and rear fascia/bumpers.

Side Distance Warning Display

The Side Distance Warning screen will only be displayed if this feature is enabled within Uconnect Settings  page 136.

The system warns the driver with an acoustic signal and, when enabled, with visual indications on the instrument cluster display.

When the vehicle is in DRIVE, the Side Distance Warning volume/chime will match the Front ParkSense volume and chime type.

When the vehicle is in REVERSE, the Side Distance Warning volume/chime will match the Rear ParkSense volume and chime type.

WARNING ALERTS

	Less than 12 inches (30 cm)	12 - 24 inches (30-60 cm)
Distance (inches/cm)	Flashing	Flashing
Arcs-Left	Flashing	Flashing
Arcs-Right	Flashing	Flashing

WARNING ALERTS		
Audible Alert Chime	Continuous	Fast audible chime as the objects get close to the vehicle
Radio Volume Reduced	Yes	Yes

NOTE:

ParkSense will reduce the volume of the radio if on when the system is sounding an audible tone. An audible tone will only sound if a collision is possible.

Activation/Deactivation

The system can operate only after driving a short distance and if the vehicle speed is between 0 and 7 mph (0 and 11 km/h). The system can be activated/deactivated via the Settings menu of the Uconnect system. If the ParkSense System is deactivated via the ParkSense hard switch, then the Side Distance Warning system will automatically be deactivated.

The system will automatically deactivate if any door is opened.

ParkSense Park Assist System Usage Precautions**NOTE:**

- Ensure that the front and rear fascia/bumper are free of snow, ice, mud, dirt and debris to keep the ParkSense system operating properly.
- Construction equipment, large trucks, and other vibrations could affect the performance of ParkSense.

- When you turn ParkSense off, the instrument cluster display will read "PARKSENSE OFF." Furthermore, once you turn ParkSense off, it remains off until you turn it on again, even if you cycle the ignition key.
- ParkSense, when on, will reduce the volume of the radio when it is sounding a tone.
- Clean the ParkSense sensors regularly, taking care not to scratch or damage them. The sensors must not be covered with ice, snow, slush, mud, dirt or debris. Failure to do so can result in the system not working properly. The ParkSense system might not detect an obstacle behind or in front of the fascia/bumper, or it could provide a false indication that an obstacle is behind or in front of the fascia/bumper.
- Use the ParkSense switch to turn the ParkSense system and Side Distance Warning off if objects such as bicycle carriers, etc. are placed within 12 inches (30 cm) from the rear fascia/bumper. Failure to do so can result in the system misinterpreting a close object as a sensor problem, causing the "PARKSENSE UNAVAILABLE SERVICE REQUIRED" message to be displayed in the instrument cluster display.

NOTE:

If any objects are attached to the bumper within a 6.5 ft (2 m) field of view, they will interfere and cause false alerts and possibly blockage.

- There may be a delay in the object detection rate if the object is moving.
- The operation of the rear sensors is automatically deactivated when the trailer's electric plug is inserted in the vehicle's tow hook socket, while the

front sensors stay active and can provide acoustic and visual warnings. The rear sensors are automatically reactivated when the trailer's cable plug is removed.

WARNING!

- Drivers must be careful when backing up even when using Side Distance Warning. Always check carefully behind your vehicle, look behind you, and be sure to check for pedestrians, animals, other vehicles, obstructions, and blind spots before backing up. You are responsible for safety and must continue to pay attention to your surroundings. Failure to do so can result in serious injury or death.
- Before using Side Distance Warning, it is strongly recommended that the ball mount and hitch ball assembly be disconnected from the vehicle when the vehicle is not used for towing. Failure to do so can result in injury or damage to vehicles or obstacles because the hitch ball will be much closer to the obstacle than the rear fascia when the vehicle sounds the continuous tone. Also, the sensors could detect the ball mount and hitch ball assembly, depending on its size and shape, giving a false indication that an obstacle is behind the vehicle.

CAUTION!

- Side Distance Warning is only a parking aid and it is unable to recognize every obstacle, including small obstacles. Parking curbs might be temporarily detected or not detected at all. Obstacles located above or below the sensors will not be detected when they are in close proximity.
- The vehicle must be driven slowly when using Side Distance Warning in order to be able to stop in time when an obstacle is detected. It is recommended that the driver looks over his/her shoulder when using ParkSense.

If it is necessary to keep the ball mount and hitch ball assembly mounted for a long period, it is possible to filter out the ball mount and hitch ball assembly presence in the sensor field of view. The filtering operation must be performed only by an authorized dealer.

REAR EMERGENCY BRAKING (BEV MODELS)

The Rear Emergency Braking (REB) system helps to mitigate rear collisions and, when avoidance is not feasible, mitigate the impact when the vehicle is moving in reverse at speeds of 6 mph (11 km/h) or lower.

REB will not be activated by obstacles lower than 8 in (20 cm) of height which do not have potential collision with the bumper.

When REB is activated, the vehicle will be slowed to 0 mph (0 km/h) by applying the brakes and reducing the engine torque to the minimum level. The system is activated when the vehicle is in REVERSE gear and moving below a specific velocity threshold of 6 mph (11 km/h) or lower. When the speed is between the

range of 6-8 mph (6-11 km/h), the system offers effective collision mitigation, providing a reliable solution when avoidance is not possible.

When REB is activated, the system will suppress additional Rear Emergency Braking events until the ultrasonic sensors no longer detect any objects behind the car. Once the sensors detect a clear path, the REB system will regain full functionality, ready to activate whenever it identifies newly detected objects.

WARNING!

Drivers must be careful when backing up even when using Rear Emergency Braking. Always check carefully behind your vehicle, look behind you, and be sure to check for pedestrians, animals, other vehicles, obstructions, and blind spots before backing up. You are responsible for safety and must continue to pay attention to your surroundings. Failure to do so can result in serious injury or death.

CAUTION!

- Rear Emergency Braking is only a parking aid and it is unable to recognize every obstacle, including small obstacles. Parking curbs might be temporarily detected or not detected at all. Obstacles located below the sensors will not be detected when they are in close proximity.

(Continued)

CAUTION!

- The vehicle must be driven slowly when using Rear Emergency Braking in order to be able to stop in time when an obstacle is detected. It is recommended that the driver looks over his/her shoulder when using ParkSense.

PARKSENSE ACTIVE PARK ASSIST SYSTEM (GAS MODELS) — IF EQUIPPED

The ParkSense Active Park Assist system is intended to assist the driver during parallel and perpendicular parking maneuvers by identifying a proper parking space, providing audible/visual instructions through the instrument cluster display, and controlling the steering wheel. The ParkSense Active Park Assist system is defined as “semi-automatic” since the driver maintains control of the accelerator, gear selector and brakes. Depending on the driver’s parking maneuver selection, the system is capable of maneuvering a vehicle into a parallel or a perpendicular parking space on either side (i.e., driver side or passenger side).

NOTE:

- The driver is always responsible for controlling the vehicle, responsible for any surrounding objects, and must intervene as required.
- The system is provided to assist the driver and not to substitute the driver.

- During a semi-automatic maneuver, if the driver touches the steering wheel after being instructed to remove their hands from the steering wheel, the system will cancel, and the driver will be required to manually complete the parking maneuver.
- The system may not work in all conditions (e.g. environmental conditions such as heavy rain, snow, etc., or if searching for a parking space that has surfaces that will absorb the ultrasonic sensor waves).
- It is important to keep the sensors clean in order for the system to operate correctly. During cleaning make sure not to scratch or damage them; avoid using dry or rough cloths. The sensors should be washed using clean water with addition of car shampoo if necessary. In washing stations, clean the sensors quickly, keeping the steam jet/high pressure washing nozzles at least 4 in (10 cm) away from the sensors.
- New vehicles from the dealership must have at least 31 miles (50 km) accumulated before the ParkSense Active Park Assist system is fully calibrated and performs accurately. This is due to the system's dynamic vehicle calibration to improve the performance of the feature.
- The driver must control the vehicle's brakes. The automatic emergency braking feature is NOT intended to substitute for the driver during REVERSE maneuvers.

ENABLING AND DISABLING THE PARKSENSE ACTIVE PARK ASSIST SYSTEM



The ParkSense Active Park Assist system can be enabled and disabled with the ParkSense Active Park Assist switch, located on the switch panel below the Uconnect display.

To enable or disable the system, push the ParkSense Active Park Assist switch once (LED turns on). Pushing the switch a second time will disable the system (LED turns off).

The ParkSense Active Park Assist system will turn off automatically for any of the following conditions:

- Parking maneuver is completed.
- Vehicle speed is greater than 18 mph (30 km/h) when searching for a parking space.
- Vehicle speed is greater than 5 mph (7 km/h) during active steering guidance into the parking space.
- Steering wheel is touched during active steering guidance into the parking space.
- If parking maneuver has not been completed after 3 minutes.
- ParkSense Front/Rear Park Assist switch is pushed.
- Driver's door is opened.
- Load compartment door is opened.
- Electronic Stability Control/Anti-Lock Braking System intervention.
- Vehicle is in 4WD Low.
- Axle Locker is active.
- Trailer is connected.

- Trailer Reverse Steering Control (TRSC) is active.
- Snowplow is connected.

NOTE:

The ParkSense Active Park Assist system will allow a maximum of eight shifts between DRIVE and REVERSE. If the maneuver cannot be completed within eight shifts, the system will cancel and the instrument cluster display will instruct the driver to complete the maneuver manually.

The ParkSense Active Park Assist system will only operate and search for a parking space when the following conditions are present:

- Gear selector is in DRIVE.
- The ignition is in the ON/RUN position.
- The ParkSense Active Park Assist switch is activated.
- Driver's door is closed.
- Load compartment door is closed.
- Vehicle speed is less than 15 mph (25 km/h).
- The outer surface and the underside of the front and rear fascias/bumpers are clean and clear of snow, ice, mud, dirt or other obstruction.

NOTE:

If the vehicle is driven above approximately 15 mph (25 km/h), the instrument cluster display will instruct the driver to slow down. If the vehicle is driven above approximately 18 mph (30 km/h), the system will cancel. The driver must then reactivate the system by pushing the ParkSense Active Park Assist switch.

When pushed, the LED on the ParkSense Active Park Assist switch will blink momentarily, and then the LED will turn off if any of the preceding conditions are not present.

PARALLEL/PERPENDICULAR PARKING SPACE ASSISTANCE OPERATION

When the ParkSense Active Park Assist system is enabled, the “Active ParkSense Searching - Press ◀ or ▶ to Switch Maneuver” message will appear in the instrument cluster display. You may select perpendicular, parallel, or parallel park exit. The arrow buttons on the left side of the steering wheel can be used to switch parking maneuvers.

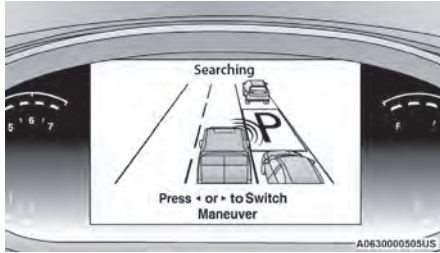

Press OK to Switch to Perpendicular Park

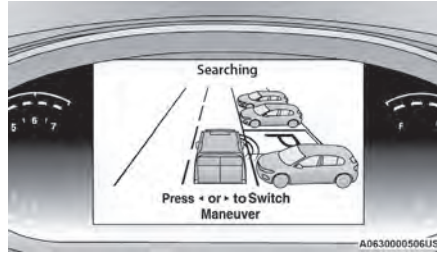

Press OK to Switch to Parallel Park

Selecting A Side

When searching for a parking space, use the turn signal indicator to select which side of the vehicle you want to perform the parking maneuver. The ParkSense Active Park Assist system will automatically search for a parking space on the passenger's side of the vehicle if the turn signal is not activated.

NOTE:

- The driver needs to make sure that the selected parking space for the maneuver remains free and clear of any obstructions (e.g. pedestrians, bicycles, etc.).
- The driver is responsible to ensure that the selected parking space is suitable for the maneuver and free/clear of anything that may be overhanging or protruding into the parking space (e.g., ladders, etc. from surrounding objects/vehicles).

- When searching for a parking space, the driver should drive as parallel or perpendicular (depending on the type of maneuver) to other vehicles as possible.
- The feature will only indicate the last detected parking space (example: if passing multiple available parking spaces, the system will only indicate the last detected parking space for the maneuver). A parking space is considered invalid after the vehicle is 32 ft (10 m) or more away from it.

Searching For A Parking Space

Through the side sensors, the system will continuously search for a free parking space suitable for the dimensions of the vehicle. While searching the vehicle should continue driving below 18 mph (30 km/h). When looking for a parallel parking space keep the vehicle 1.5 ft to 5 ft (50cm to 1.5 m) from parked vehicles. When looking for a perpendicular parking space keep the vehicle 3 ft to 6 ft (1 m to 2 m) from parked vehicles.

When an available parking space has been found, and the vehicle is not in position, you will be instructed to move forward to position the vehicle for a perpendicular or parallel parking sequence (depending on the type of maneuver being performed).

Once the vehicle is in position, you will be instructed to stop the vehicle's movement and remove your hands from the steering wheel. When the vehicle comes to a standstill (your hands still removed from the steering wheel), you will be instructed to place the gear selector into the REVERSE position.

The system may then instruct the driver to wait for steering to complete before then instructing to check surroundings and move backward.

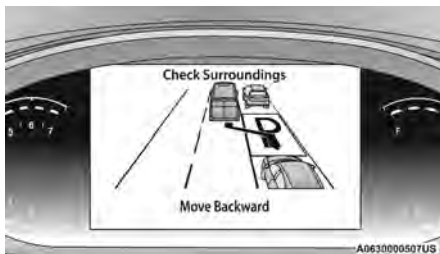

Move Backward Into Parallel Parking Space

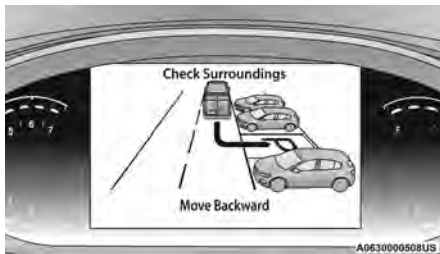

Move Backward Into Perpendicular Parking Space

The system may instruct several more gear shifts (DRIVE and REVERSE), with hands off of the steering wheel, before instructing the driver to check surroundings and complete the parking maneuver.

When the vehicle is in the parking position, the maneuver is complete and the driver will be instructed to check the vehicle's parking position, then shift the vehicle into PARK. The message "Active ParkSense Complete - Check Parking Position" will be displayed momentarily.

NOTE:

- It is the driver's responsibility to use the brake and accelerator during the semi-automatic parking maneuver.
- It is the driver's responsibility to use the brake and stop the vehicle. The driver should check their surroundings and be prepared to stop the vehicle either when instructed to, or when driver intervention is required.
- When the system instructs the driver to remove their hands from the steering wheel, the driver should check their surroundings and begin to back up slowly.
- The ParkSense Active Park Assist system will allow a maximum of eight shifts between DRIVE and REVERSE. If the maneuver cannot be completed within eight shifts, the system will cancel and the instrument cluster display will instruct the driver to complete the maneuver manually.
- The system will cancel the maneuver if the vehicle speed exceeds 5 mph (7 km/h) during active steering guidance into the parking space. The system will provide a warning to the driver at 3 mph (5 km/h) that tells them to slow down. The driver is then responsible for completing the maneuver if the system is canceled.

- If the system is canceled during the maneuver for any reason, the driver must take control of the vehicle.

WARNING!

- Drivers must be careful when performing parallel or perpendicular parking maneuvers even when using the ParkSense Active Park Assist system. Always check carefully behind and in front of your vehicle, look behind and in front of you, and be sure to check for pedestrians, animals, other vehicles, obstructions, and blind spots before backing up and moving forward. You are responsible for safety and must continue to pay attention to your surroundings. Failure to do so can result in serious injury or death.
- Before using the ParkSense Active Park Assist system, it is strongly recommended that the ball mount and hitch ball assembly be disconnected from the vehicle when the vehicle is not used for towing. Failure to do so can result in injury or damage to vehicles or obstacles because the hitch ball will be much closer to the obstacle than the rear fascia when the vehicle sounds the continuous tone. Also, the sensors could detect the ball mount and hitch ball assembly, depending on its size and shape, giving a false indication that an obstacle is behind the vehicle.

CAUTION!

- The ParkSense Active Park Assist system is only a parking aid and it is unable to recognize every obstacle, including small obstacles. Parking curbs might be temporarily detected or not detected at all. Obstacles located above or below the sensors' field of view will not be detected when they are in close proximity.
- The vehicle must be driven slowly when using the ParkSense Active Park Assist system in order to be able to stop in time when an obstacle is detected. It is recommended that the driver looks over his/her shoulders when using the ParkSense Active Park Assist system.

EXITING THE PARKING SPACE**NOTE:**

The function does not work for exiting a perpendicular parking space, but only exiting parallel parking spaces.

Activation

To activate this function, push the Active ParkSense switch once. After selection, the system activates and warns the driver on the instrument cluster display about the operations that have to be carried out to perform the maneuver correctly.

Selection Of The Maneuver Side

Use the direction indicators to choose the direction that you want to perform the maneuver. Use the right arrow indicator to perform the maneuver to the right side and use the left arrow indicator to perform the maneuver to the left.

During the maneuver, the system instructs the driver to shift to REVERSE, and operate the turn signal in the

direction you want to exit. Let go of the steering wheel and use the brake or accelerator pedals as instructed, while the system handles the steering automatically for exiting the parking space. If the driver continues to carry out a voluntary or involuntary action on the steering wheel during the exit maneuver (touching or holding the steering wheel to prevent its movement), the maneuver will be interrupted.

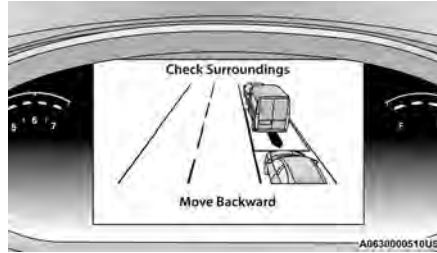
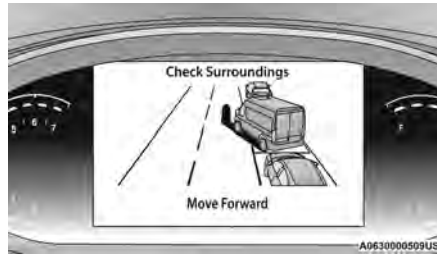
**Shift To Reverse Then Move Backward****Shift To Drive Then Move Forward****End Of Maneuver**

The semi-automatic maneuver ends when the display shows the message of a completed maneuver. At the end of the maneuver, the system gives back the vehicle control to the driver.

LANESENSE — IF EQUIPPED**LANESENSE OPERATION**

The LaneSense system is operational at speeds above 37 mph (60 km/h) and below 112 mph (180 km/h). The LaneSense system uses a forward-facing camera to detect lane markings and measure vehicle position within the lane boundaries.

When both lane markings are detected and the driver drifts out of the lane (no turn signal applied), the LaneSense system provides a haptic warning in the form of torque applied to the steering wheel, as well as a visual warning in the instrument cluster display, to prompt the driver to remain within the lane boundaries.

The driver may manually override the haptic warning by applying force to the steering wheel at any time.

When only a single lane marking is detected and the driver drifts across the lane marking (no turn signal applied), the LaneSense system provides a visual warning through the instrument cluster display to prompt the driver to remain within the lane.

When only a single lane marking is detected, a haptic or a torque warning will not be provided.

NOTE:

- When operating conditions have been met, the LaneSense system will monitor if the driver's hands are on the steering wheel and provide an audible and visual warning to the driver if removed. The system will cancel if the driver does not return their hands to the wheel.
- LaneSense is a driving assist system, not an emergency system, and does not replace the driver. The driver is always responsible for controlling the vehicle and must intervene as required. The LaneSense system is designed to assist the driver and not to substitute the driver.

TURNING LANESENSE ON OR OFF

The LaneSense button is located on the switch panel below the Uconnect display.

To turn the LaneSense system on, push the LaneSense button (LED turns off). A "LaneSense On" message is shown in the instrument cluster display.

To turn the LaneSense system off, push the LaneSense button twice (LED turns on).

NOTE:

The LaneSense system will retain the last system state on or off from the last ignition cycle when the ignition is placed in the ON/RUN position.

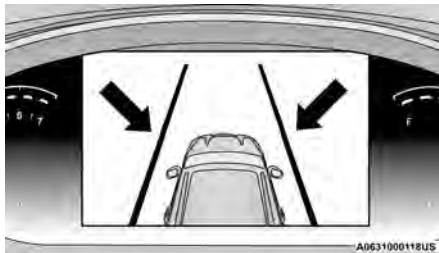

LANESENSE WARNING MESSAGE

The LaneSense system will indicate the current lane drift condition through the instrument cluster display. When the LaneSense system is on, the lane lines are gray when both of the lane boundaries have not been detected and the LaneSense telltale  is solid white.



System ON (Gray Lines) With White Telltale

Left Lane Departure — Only Left Lane Detected

- When the LaneSense system is on, the LaneSense Telltale  is solid white when only the left lane marking has been detected and the system is ready to provide visual warnings in the instrument cluster display if an unintentional lane departure occurs on the left side.
- When the LaneSense system senses the lane has been approached and is in a lane departure situation, the visual warning in the instrument cluster display will show the left lane line flashing yellow (on/off). The LaneSense telltale  changes from solid white to flashing yellow.

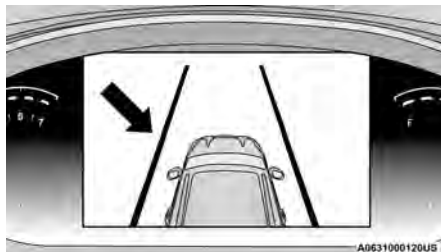

Lane Approached (Flashing Yellow Lane Line) With Yellow Telltale

NOTE:

The LaneSense system operates with similar behavior for a right lane departure when only the right lane marking has been detected.

Left Lane Departure — Both Lane Lines Detected

- When the LaneSense system is on and both the lane markings have been detected, the system is armed to provide visual warnings in the instrument cluster display and a torque warning in the steering wheel if an unintentional lane departure occurs. The lane lines turn from gray to white and the LaneSense telltale  is solid green.

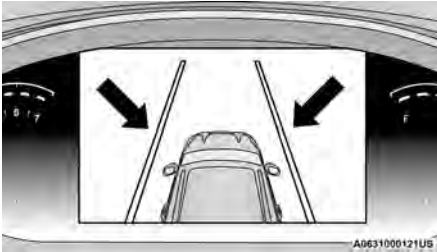

Lanes Sensed (White Lines) With Green Telltale

- When the LaneSense system senses a lane drift situation, the left lane line turns solid yellow. The LaneSense telltale  changes from solid green to solid yellow. At this time torque is applied to the steering wheel in the opposite direction of the lane boundary.

For example: If approaching the left side of the lane the steering wheel will turn to the right.

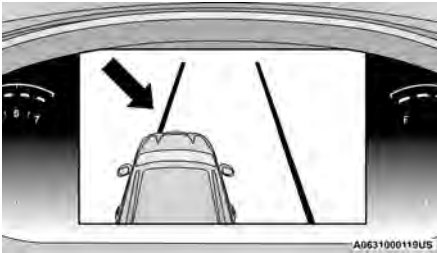

Lane Sensed (Solid Yellow Lane Line) With Solid Yellow Telltale

- When the LaneSense system senses the lane has been approached and is in a lane departure situation, the left lane line flashes yellow (on/off). The LaneSense telltale  changes from solid yellow to flashing yellow. At this time torque is applied to the steering wheel in the opposite direction of the lane boundary.

For example: If approaching the left side of the lane the steering wheel will turn to the right.

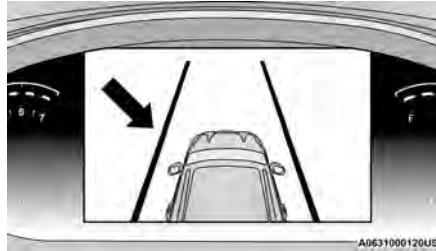

Lane Approached (Flashing Yellow Lane Line) With Flashing Yellow Telltale

NOTE:

The LaneSense system operates with similar behavior for a right lane departure.

CHANGING LANESENSE STATUS

The LaneSense system has settings to adjust the intensity of the torque warning and the warning zone sensitivity (Early/Medium/Late) that you can configure through the Uconnect system  page 136.

NOTE:

- When enabled the system operates above 37 mph (60 km/h) and below 112 mph (180 km/h).
- The warnings are disabled with use of the turn signal.
- The system will not apply torque to the steering wheel whenever a safety system engages (Anti-Lock Brakes, Traction Control System, Electronic Stability Control, Forward Collision Warning, etc.).

PARKVIEW REAR BACK UP CAMERA

Your vehicle is equipped with the ParkView Rear Back Up Camera that allows you to see an on-screen image of the rear surroundings of your vehicle whenever the gear selector is put into REVERSE and/or when the rear doors are opened. The image will be displayed on the touchscreen display along with a caution note to "Check Entire Surroundings" across the top of the screen. After five seconds this note will disappear. The ParkView Rear Back Up Camera is located on the top rear of the vehicle below the center light.



AG832000024US

Rear Back Up Camera Location

When the vehicle is shifted out of REVERSE and/or when the rear doors are closed, the rear camera mode is exited and the previous screen appears.

When engaged in the REVERSE gear, with Camera Delay turned on, the camera image will continue to be displayed for up to 10 seconds after switching out of the REVERSE position, unless the speed of the vehicle does not exceed 8 mph (13 km/h), or that the gear is placed in the NEUTRAL or PARK position. The touchscreen X button to disable the camera image is made available ONLY when the vehicle is not in REVERSE.

NOTE:

The image displayed on the display may appear slightly deformed.

When displayed, active grid lines will illustrate the width of the vehicle and will show separate zones that will help indicate the distance to the rear of the vehicle. The following table shows the approximate distances for each zone:

Zone	Distance To The Rear Of The Vehicle
Red	0 - 1 ft (0 - 30 cm)
Yellow	1 ft - 3 ft (30 cm - 1 m)
Green	3 ft or greater (1 m or greater)

WARNING!

Drivers must be careful when backing up even when using the Rear Back Up Camera. Always check carefully behind your vehicle, and be sure to check for pedestrians, animals, other vehicles, obstructions, or blind spots before backing up. You are responsible for the safety of your surroundings and must continue to pay attention while backing up. Failure to do so can result in serious injury or death.

CAUTION!

- To avoid vehicle damage, ParkView should only be used as a parking aid. The ParkView camera is unable to view every obstacle or object in your drive path.
- To avoid vehicle damage, the vehicle must be driven slowly when using ParkView to be able to stop in time when an obstacle is seen. It is recommended that the driver look frequently over his/her shoulder when using ParkView.

NOTE:

If snow, ice, mud, or any foreign substance builds up on the camera lens, clean the lens, rinse with water, and dry with a soft cloth. Do not cover the lens.

SURROUND VIEW CAMERA SYSTEM — IF EQUIPPED

Your vehicle may be equipped with the Surround View Camera system that allows you to see an on-screen image of the surroundings and Top View of your vehicle whenever the gear selector is put into REVERSE or a different view is selected through the touchscreen buttons. The Top View of the vehicle will show which doors are open. The image will be displayed on the touchscreen display along with a caution note “Check Entire Surroundings” across the top of the screen. After five seconds, this note will disappear. The Surround View Camera system is comprised of four sequential cameras located in the front grille, rear Center High Mounted Stop Lamp (CHMSL), and side mirrors.

NOTE:

The Surround View Camera system has programmable settings that may be selected through the Uconnect system → page 136.

When the vehicle is shifted into REVERSE, the Rear View and Top View is the default view of the system.

When the vehicle is shifted out of REVERSE with camera delay turned on, the camera image will continue to be displayed for up to 10 seconds unless the vehicle speed exceeds 8 mph (13 km/h), the vehicle is shifted into PARK, or the ignition is placed in the OFF position. There is a touchscreen X button to disable the display of the camera image.

When the vehicle is shifted out of REVERSE with camera delay turned off, the Surround View system is exited and the last monitor screen appears again.

Whenever the Rear View Camera image is activated through the Back Up Camera button in the Controls menu, and the vehicle speed is greater than, or equal to, 8 mph (13 km/h), a display timer for the image is initiated. The image will continue to be displayed until the display timer exceeds 10 seconds.

NOTE:

- If the vehicle speed remains below 8 mph (13 km/h), the Rear View Camera image will be displayed continuously until deactivated via the touchscreen X button, the transmission is shifted into PARK, or the ignition is placed in the OFF position.
- The touchscreen X button to disable display of the camera image is made available ONLY when the vehicle is not in REVERSE.

When enabled, active guidelines are overlaid on the image to illustrate the width of the vehicle, including the side view mirrors and its projected back up path based on the steering wheel position.

Different colored zones indicate the distance to the rear of the vehicle.

The following table shows the approximate distances for each zone:

Zone	Distance To The Rear Of The Vehicle
Red	0 - 1 ft (0 - 30 cm)
Yellow	1 ft - 6.5 ft (30 cm - 2 m)
Green	6.5 ft or greater (2 m or greater)

Modes Of Operation

Manual activation of the Surround View system is selected by pressing the Surround View Camera button located in the Controls screen within the Uconnect system.

Top View

The Top View will show in the Uconnect system with Rear View or Front View in a split screen display. There are integrated ParkSense arcs in the image at the front and rear of the vehicle. The arcs will change color from yellow to red corresponding the distance zones to the oncoming object.

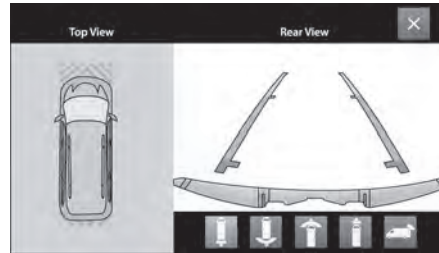

Surround View Camera View

NOTE:

- Front tires will be in image when the tires are turned.
- Due to wide angle cameras in the mirrors, the image will appear distorted.
- Top View will show which sliding doors are open.
- Open front doors will remove outside image.

Rear View



This is the default view of the system in REVERSE and is always paired with the Top View of the vehicle with optional active guidelines for the projected path when enabled.

Rear Cross Path View



Pressing the Rear Cross Path button will give the driver a wider angle view of the Rear View. The Top View will be disabled when this is selected.

Front View



The Front View will show you what is immediately in front of the vehicle and is always paired with the Top View of the vehicle.

Front Cross Path View



Pressing the Front Cross Path button will give the driver a wider angle view of the Front View. The Top View will be disabled when this is selected.

Back Up Camera View



Pressing the Back Up Camera button will provide a full screen rear view.

NOTE:

If the Back Up Camera was selected through the Surround View Camera menu, exiting out of screen display will return to the Surround View menu. If the Back Up Camera was manually activated through the Controls menu of the Uconnect system, exiting out of the display screen will return to the Controls menu.

Deactivation

The system can be deactivated under the following conditions:

- The speed of the vehicle is greater than 8 mph (13 km/h).
- The vehicle shifted into PARK.
- The vehicle is in any gear other than REVERSE and the touchscreen X button is pressed.
- The camera delay system is turned off manually through the Uconnect Settings ➔ page 136.

NOTE:

- If snow, ice, mud, or any foreign substance builds up on the camera lenses, clean the lenses, rinse with water, and dry with a soft cloth. Do not cover the lenses.
- If a malfunction with the system has occurred, see an authorized dealer.

WARNING!

Drivers must be careful when backing up even when using the Surround View Camera. Always check carefully behind your vehicle, and be sure to check for pedestrians, animals, other vehicles, obstructions, or blind spots before backing up. You are responsible for the safety of your surroundings and must continue to pay attention while backing up. Failure to do so can result in serious injury or death.

CAUTION!

- To avoid vehicle damage, Surround View should only be used as a parking aid. The Surround View camera is unable to view every obstacle or object in your drive path.
- To avoid vehicle damage, the vehicle must be driven slowly when using Surround View to be able to stop in time when an obstacle is seen. It is recommended that the driver look frequently over his/her shoulder when using Surround View.

REFUELING THE VEHICLE

The gas cap is located behind the fuel filler door on the left side of the vehicle. If the gas cap is lost or damaged, be sure to use the correct replacement cap for this vehicle.

1. Open the fuel filler door.
2. Remove the fuel cap by rotating it counterclockwise.

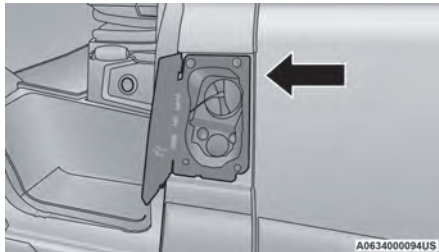
**Fuel Filler**

3. Fully insert the fuel nozzle into the filler pipe.
4. Fill the vehicle with fuel.

NOTE:

- When the fuel nozzle “clicks” or shuts off, the fuel tank is full.
 - Wait five seconds before removing the fuel nozzle to allow excess fuel to drain from the nozzle.
5. Remove the fuel nozzle, reinstall fuel cap and close fuel filler door.

NOTE:

During fuel fill, nozzle position could affect the flow of fuel. For best results, allow the nozzle to rest naturally in the filler tube - do not raise the handle to increase the fill angle.

WARNING!

- Never have any smoking materials lit in or near the vehicle when the fuel door is open or the tank is being filled.
- Never add fuel when the engine is running. This is in violation of most state and federal fire regulations and may cause the Malfunction Indicator Light to turn on.
- A fire may result if fuel is pumped into a portable container that is inside of a vehicle. You could be burned. Always place fuel containers on the ground while filling.

CAUTION!

- Damage to the fuel system or emissions control system could result from using an improper fuel tank filler tube cap.
- A poorly fitting fuel filler cap could let impurities into the fuel system.
- A poorly fitting fuel filler cap may cause the Malfunction Indicator Light (MIL) to turn on.
- To avoid fuel spillage and overfilling, do not “top off” the fuel tank after filling. When the fuel nozzle “clicks” or shuts off, the fuel tank is full.

NOTE:

- Tighten the fuel filler cap until you hear a “clicking” sound. This is an indication that the fuel filler cap is properly tightened.
- If the gas cap is not tightened properly, the MIL may come on. Be sure the gas cap is tightened every time the vehicle is refueled.

LOOSE FUEL FILLER CAP MESSAGE

If the vehicle diagnostic system determines that the fuel filler cap is loose, improperly installed, or damaged, a “Check Fuel Cap” message will be displayed in the instrument cluster display ➔ page 69. Tighten the fuel filler cap until a “clicking” sound is heard. This is an indication that the fuel filler cap is properly tightened. If the problem continues, the message will appear the next time the vehicle is started. See an authorized dealer as soon as possible.

VEHICLE LOADING

As required by National Highway Traffic Safety Administration regulations, your vehicle has a certification label affixed to the driver’s side door or B-pillar.

If seats are removed for carrying cargo, do not exceed the specified GVWR and GAWR.

VEHICLE CERTIFICATION LABEL

Your vehicle has a Vehicle Certification Label affixed to the driver’s side B-pillar or the rear of the driver’s door.

The label contains the following information:

- Name of manufacturer
- Month and year of manufacture
- Gross Vehicle Weight Rating (GVWR)
- Gross Axle Weight Rating (GAWR) front and rear
- Vehicle Identification Number (VIN)
- Type of vehicle
- Month, Day, and Hour (MDH) of manufacture

The bar code allows a computer scanner to read the VIN.

GROSS VEHICLE WEIGHT RATING (GVWR)

The GVWR is the total allowable weight of your vehicle. This includes driver, passengers, and cargo. The total load must be limited so that you do not exceed the GVWR.

GROSS AXLE WEIGHT RATING (GAWR)

The GAWR is the maximum capacity of the front and rear axles. Distribute the load over the front and rear axles evenly. Make sure that you do not exceed either front or rear GAWR.

WARNING!

Because the front wheels steer the vehicle, it is important that you do not exceed the maximum front or rear GAWR. A dangerous driving condition can result if either rating is exceeded. You could lose control of the vehicle and have a collision.

4**TIRE SIZE**

The tire size on the Vehicle Certification Label represents the actual tire size on your vehicle. Replacement tires must be equal to the load capacity of this tire size.

RIM SIZE

This is the rim size that is appropriate for the tire size listed.

INFLATION PRESSURE

This is the cold tire inflation pressure for your vehicle for all loading conditions up to full Gross Axle Weight Rating (GAWR).

CURB WEIGHT

The curb weight of a vehicle is defined as the total weight of the vehicle with all fluids, including vehicle fuel, at full capacity conditions, and with no occupants or cargo loaded into the vehicle. The front and rear curb weight values are determined by weighing your vehicle on a commercial scale before any occupants or cargo are added.

OVERLOADING

The load carrying components (axle, springs, tires, wheels, etc.) of your vehicle will provide satisfactory service as long as you do not exceed the Gross Vehicle Weight Rating (GVWR) and the front and rear Gross Axle Weight Rating (GAWR).

The best way to figure out the total weight of your vehicle is to weigh it when it is fully loaded and ready for operation. Weigh it on a commercial scale to ensure that it is not over the GVWR.

Figure out the weight on the front and rear axle of the vehicle separately. It is important that you distribute the load evenly over the front and rear axles.

Overloading can cause potential safety hazards and shorten useful service life. Heavier axles or suspension components do not necessarily increase the vehicle's GVWR.

LOADING

To load your vehicle properly, first figure out its empty weight, axle-by-axle and side-by-side. Store heavier items down low and be sure you distribute their weight as evenly as possible. Stow all loose items securely before driving. If weighing the loaded vehicle shows that you have exceeded either Gross Axle Weight Rating (GAWR), but the total load is within the specified Gross

Vehicle Weight Rating (GVWR), you must redistribute the weight. Improper weight distribution can have an adverse effect on the way your vehicle steers and handles and the way the brakes operate.

NOTE:

Refer to the Vehicle Certification Label affixed to the rear of the driver's door for your vehicle's GVWR and GAWRs.

TRAILER TOWING

In this section you will find safety tips and information on limits to the type of towing you can reasonably do with your vehicle.

To maintain the New Vehicle Limited Warranty coverage, follow the requirements and recommendations in this manual concerning vehicles used for trailer towing.

Gasoline Vehicle

Before towing a trailer, carefully review this information to tow your load as efficiently and safely as possible.

Battery Electric Vehicle (BEV)

Trailer Towing is not recommended for this vehicle.

COMMON TOWING DEFINITIONS

The following trailer towing related definitions will assist you in understanding the following information:

Gross Vehicle Weight Rating (GVWR)

The GVWR is the total allowable weight of your vehicle. This includes driver, passengers, cargo and tongue weight. The total load must be limited so that you do not exceed the GVWR [↪ page 127](#).

Gross Combination Weight Rating (GCWR)

The GCWR is the total allowable weight of your vehicle and trailer when weighed in combination.

Gross Trailer Weight (GTW)

The GTW is the weight of the trailer plus the weight of all cargo, consumables and equipment (permanent or temporary) loaded in or on the trailer in its "loaded and ready for operation" condition.

The recommended way to measure GTW is to put your fully loaded trailer on a vehicle scale. The entire weight of the trailer must be supported by the scale.

Gross Axle Weight Rating (GAWR)

The GAWR is the maximum capacity of the front and rear axles. Distribute the load over the front and rear axles evenly. Make sure that you do not exceed either front or rear GAWR [↪ page 127](#).

WARNING!

It is important that you do not exceed the maximum front or rear GAWR. A dangerous driving condition can result if either rating is exceeded. You could lose control of the vehicle and have a collision.

Tongue Weight (TW)

The TW is the downward force exerted on the hitch ball by the trailer. You must consider this as part of the load on your vehicle.

Trailer Frontal Area

The frontal area is the maximum height multiplied by the maximum width of the front of a trailer.

Trailer Sway Control (TSC)

The TSC can be a mechanical telescoping link that can be installed between the hitch receiver and the trailer tongue that typically provides adjustable friction associated with the telescoping motion to dampen any unwanted trailer swaying motions while traveling.

If equipped, an electronic TSC recognizes a swaying trailer and automatically applies individual wheel brakes and/or reduces engine power to attempt to eliminate the trailer sway.

Weight-Carrying Hitch

A weight-carrying hitch supports the trailer tongue weight, just as if it were luggage located at a hitch ball or some other connecting point of the vehicle. These kinds of hitches are commonly used to tow small and medium sized trailers.

Weight-Distributing Hitch

A Weight-Distributing Hitch system works by applying leverage through spring (load) bars. They are typically used for heavier loads to distribute trailer tongue weight to the tow vehicle's front axle and the trailer axle(s). When used in accordance with the manufacturer's directions, it provides for a more level ride, offering more consistent steering and brake control thereby enhancing towing safety. The addition of a friction/hydraulic sway control also dampens sway caused by traffic and crosswinds and contributes positively to tow vehicle and trailer stability. Trailer sway control and a Weight-Distributing (load equalizing) Hitch are recommended for heavier Tongue Weights (TW) and may be required depending on vehicle and trailer configuration/loading to comply with Gross Axle Weight Rating (GAWR) requirements.

WARNING!

- An improperly adjusted Weight-Distributing Hitch system may reduce handling, stability, braking performance, and could result in a collision.
- Weight-Distributing Hitch systems may not be compatible with surge brake couplers. Consult with your hitch and trailer manufacturer or a reputable Recreational Vehicle dealer for additional information.

TRAILER HITCH CLASSIFICATION

The following chart provides the industry standard for the maximum trailer weight a given trailer hitch class can tow and should be used to assist you in selecting the correct trailer hitch for your intended towing condition.

4

Trailer Hitch Classification Definitions	
Class	Max. Trailer Hitch Industry Standards
Class I - Light Duty	2,000 lb (907 kg)
Class II - Medium Duty	3,500 lb (1,587 kg)
Class III - Heavy Duty	6,000 lb (2,722 kg)
Class IV - Extra Heavy Duty	10,000 lb (4,535 kg)
Refer to the "Trailer Towing Weights (Maximum Trailer Weight Ratings)" chart for the Maximum Gross Trailer Weight (GTW) towable for your given drivetrain.	
All trailer hitches should be professionally installed on your vehicle.	

TRAILER TOWING WEIGHTS (MAXIMUM TRAILER WEIGHT RATINGS)

NOTE:

For trailer towing information (maximum trailer weight ratings) refer to the following website addresses:

www.ramtrucks.com/ram-commercial/body-builders-guide

To locate trailer towing specifications follow these steps:

1. Select the model year



Select Model Year

2. Select the model



Select Model

3. Scroll down the page to Technical Information

4. Click to expand Technical Information and select Base/Weights/GCW/Payload/Trailer Tow



Select Technical Information and Weights

TRAILER AND TONGUE WEIGHT

Never exceed the maximum tongue weight stamped on your bumper or trailer hitch.

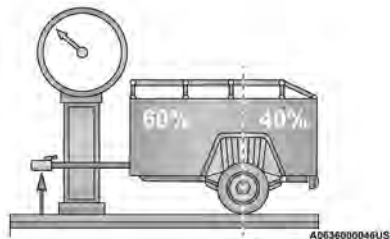

Weight Distribution

WARNING!

Always load a trailer with 60% of the weight in the front of the trailer. This places 10% of the GTW on the tow hitch of your vehicle. Loads balanced over the wheels or heavier in the rear can cause the trailer to sway severely side to side which will cause loss of control of the vehicle and trailer. Failure to load trailers heavier in front is the cause of many trailer collisions.

Consider the following items when computing the weight on the rear axle of the vehicle:

- The tongue weight of the trailer.
- The weight of any other type of cargo or equipment put in or on your vehicle.
- The weight of the driver and all passengers.

NOTE:

Remember that everything put into or on the trailer adds to the load on your vehicle. Also, additional factory-installed options or dealer-installed options must be considered as part of the total load on your vehicle. Refer to the Tire And Loading Information placard for the maximum combined weight of occupants and cargo for your vehicle → page 247.

TOWING REQUIREMENTS

To promote proper break-in of your new vehicle drive-train components, the following guidelines are recommended.

CAUTION!

- Do not tow a trailer at all during the first 500 miles (805 km) the new vehicle is driven. The engine, axle or other parts could be damaged.
- Then, during the first 500 miles (805 km) that a trailer is towed, do not drive over 50 mph (80 km/h) and do not make starts at full throttle. This helps the engine and other parts of the vehicle wear in at the heavier loads.

Perform the maintenance listed in the Scheduled Servicing → page 213. When towing a trailer, never exceed the GAWR or GCWR ratings.

WARNING!

Improper towing can lead to a collision. Follow these guidelines to make your trailer towing as safe as possible:

- Make certain that the load is secured in the trailer and will not shift during travel. When trailering cargo that is not fully secured, dynamic load shifts can occur that may be difficult for the driver to control. You could lose control of your vehicle and have a collision.
- When hauling cargo or towing a trailer, do not overload your vehicle or trailer. Overloading can cause a loss of control, poor performance or damage to brakes, axle, engine, transmission, steering, suspension, chassis structure or tires.
- Safety chains must always be used between your vehicle and trailer. Always connect the chains to the hook retainers of the vehicle hitch. Cross the chains under the trailer tongue and allow enough slack for turning corners.
- Vehicles with trailers should not be parked on a grade. When parking, apply the parking brake on the tow vehicle. Put the tow vehicle transmission in PARK. For four-wheel drive vehicles, make sure the transfer case is not in NEUTRAL. Always, block or "chock" the trailer wheels.
- GCWR must not be exceeded.
- **Total weight must be distributed between the tow vehicle and the trailer such that the following four ratings are not exceeded:**
 - GVWR
 - GTW
 - GAWR
 - Tongue weight rating for the trailer hitch utilized

Towing Requirements — Tires

- Do not attempt to tow a trailer while using a compact spare tire.
- Do not drive more than 50 mph (80 km/h) when towing while using a full size spare tire.
- Proper tire inflation pressures are essential to the safe and satisfactory operation of your vehicle.
- Check the trailer tires for proper tire inflation pressures before trailer usage.
- Check for signs of tire wear or visible tire damage before towing a trailer.
- Replacing tires with a higher load carrying capacity will not increase the vehicle's GVWR and GAWR limits.
- For further information → page 244.

Towing Requirements — Trailer Brakes

- Do **not** interconnect the hydraulic brake system or vacuum system of your vehicle with that of the trailer. This could cause inadequate braking and possible personal injury.
- An electronically actuated trailer brake controller is required when towing a trailer with electronically actuated brakes. When towing a trailer equipped with a hydraulic surge actuated brake system, an electronic brake controller is not required.
- Trailer brakes are recommended for trailers over 1,000 lb (453 kg) and may be required for any trailer, for example trailers in excess of 2,000 lb (907 kg). Trailer brake requirements vary by local law, consult local legal requirements where the trailer is to be towed for trailer brake requirements.

WARNING!

- Do not connect trailer brakes to your vehicle's hydraulic brake lines. It can overload your brake system and cause it to fail. You might not have brakes when you need them and could have an accident.
- Towing any trailer will increase your stopping distance. When towing, you should allow for additional space between your vehicle and the vehicle in front of you. Failure to do so could result in an accident.

CAUTION!

If the trailer weighs more than 1,000 lb (453 kg) loaded, it should have its own brakes and they should be of adequate capacity. Failure to do this could lead to accelerated brake lining wear, higher brake pedal effort, and longer stopping distances.

Towing Requirements — Trailer Lights And Wiring

Whenever you pull a trailer, regardless of the trailer size, stop lights and turn signals on the trailer are required for motoring safety.

The Trailer Tow Package may include a four- and seven-pin wiring harness. Use a factory approved trailer harness and connector.

NOTE:

Do not cut or splice wiring into the vehicle's wiring harness.

The electrical connections are all complete to the vehicle but you must mate the harness to a trailer connector. Refer to the following illustrations.

NOTE:

- Disconnect the trailer wiring connector from the vehicle (or any other device plugged into vehicle's electrical connectors) before launching a boat into water.
- Be sure to reconnect after clear from water area.

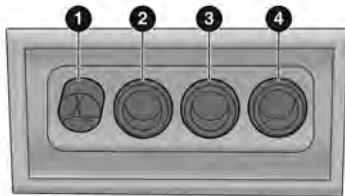

M0636000043US

Four-Pin Connector

- 1 — Ground
- 2 — Tail Lamp
- 3 — Left Stop/Turn
- 4 — Right Stop/Turn

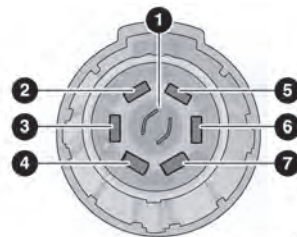

A0636000085US

Seven-Pin Connector

- 1 — Backup Lamps
- 2 — Tail Lamp
- 3 — Left Stop/Turn
- 4 — Ground
- 5 — Battery
- 6 — Right Stop/Turn
- 7 — Electric Brakes

TOWING TIPS

Before towing, practice turning, stopping, and backing up the trailer in an area located away from heavy traffic.

Automatic Transmission

The DRIVE range can be selected when towing. The transmission controls include a drive strategy to avoid frequent shifting when towing. However, if frequent shifting does occur while in DRIVE, select TOW/HAUL mode or select a lower gear range (using the Electronic Range Select (ERS) shift control).

NOTE:

Using TOW/HAUL mode or selecting a lower gear range (using the ERS shift control) while operating the vehicle under heavy loading conditions will improve performance and extend transmission life by reducing excessive shifting and heat buildup. This action will also provide better engine braking.

When towing a loaded trailer up steep grades at low speeds, holding your vehicle in FIRST gear (using the ERS shift control) can help to avoid transmission overheating.

Tow/Haul Mode

To reduce potential for automatic transmission overheating, activate TOW/HAUL mode when driving in hilly areas, or select a lower gear range (using the Electronic Range Select (ERS) shift control) on more severe grades.

Cruise Control — If Equipped

- Do not use on hilly terrain or with heavy loads.
- When using the Cruise Control, if you experience speed drops greater than 10 mph (16 km/h), disengage until you can get back to cruising speed.
- Use Cruise Control in flat terrain and with light loads to maximize fuel efficiency.

RECREATIONAL TOWING (BEHIND MOTORHOME)**TOWING THIS VEHICLE BEHIND ANOTHER VEHICLE**

Towing Condition	Wheels OFF the Ground	Automatic Transmission
Flat Tow	NONE	NOT ALLOWED
Dolly Tow	Front	OK
	Rear	NOT ALLOWED
On Trailer	ALL	OK

NOTE:

When towing your vehicle, always follow applicable state and provincial laws. Contact state and provincial Highway Safety offices for additional details.

RECREATIONAL TOWING

Recreational towing is allowed **ONLY** if the front wheels are **OFF** the ground. This may be accomplished using a tow dolly or vehicle trailer. If using a tow dolly, follow this procedure:

1. Properly secure the dolly to the tow vehicle, following the dolly manufacturer's instructions.
2. Drive the front wheels onto the tow dolly.
3. Apply the Electric Park Brake. Place the transmission in PARK.
4. Properly secure the front wheels to the dolly, following the dolly manufacturer's instructions.
5. Release the Electric Park Brake.

CAUTION!

- DO NOT flat tow this vehicle. Damage to the drivetrain will result. If this vehicle requires towing, make sure the drive wheels are OFF the ground.

(Continued)

CAUTION!

- Towing this vehicle in violation of the previously listed requirements can cause severe transmission damage. Damage from improper towing is not covered under the New Vehicle Limited Warranty.

DRIVING TIPS**DRIVING ON SLIPPERY SURFACES****Acceleration**

Rapid acceleration on snow covered, wet, or other slippery surfaces may cause the driving wheels to pull erratically to the right or left. This phenomenon occurs when there is a difference in the surface traction under the front (driving) wheels.

WARNING!

Rapid acceleration on slippery surfaces is dangerous. Unequal traction can cause sudden pulling of the front wheels. You could lose control of the vehicle and possibly have a collision. Accelerate slowly and carefully whenever there is likely to be poor traction (ice, snow, wet, mud, loose sand, etc.).

Traction

When driving on wet or slushy roads, it is possible for a wedge of water to build up between the tire and road surface. This is hydroplaning and may cause partial or complete loss of vehicle control and stopping ability. To reduce this possibility, the following precautions should be observed:

- Slow down during rainstorms or when the roads are slushy.

- Slow down if the road has standing water or puddles.
- Replace the tires when tread wear indicators first become visible.
- Keep tires properly inflated.
- Maintain sufficient distance between your vehicle and the vehicle in front of you to avoid a collision in a sudden stop.

DRIVING THROUGH WATER

Driving through water more than a few inches/centimeters deep will require extra caution to ensure safety and prevent damage to your vehicle.

Flowing/Rising Water**WARNING!**

Do not drive on or across a road or path where water is flowing and/or rising (as in storm run-off). Flowing water can wear away the road or path's surface and cause your vehicle to sink into deeper water. Furthermore, flowing and/or rising water can carry your vehicle away swiftly. Failure to follow this warning may result in injuries that are serious or fatal to you, your passengers, and others around you.

Shallow Standing Water

Although your vehicle is capable of driving through shallow standing water, consider the following Cautions and Warnings before doing so.

WARNING!

- Driving through standing water limits your vehicle's traction capabilities. Do not exceed 5 mph (8 km/h) when driving through standing water.
- Driving through standing water limits your vehicle's braking capabilities, which increases stopping distances. Therefore, after driving through standing water, drive slowly and lightly press on the brake pedal several times to dry the brakes.
- Failure to follow these warnings may result in injuries that are serious or fatal to you, your passengers, and others around you.

CAUTION!

- Always check the depth of the standing water before driving through it. Never drive through standing water that is deeper than the bottom of the tire rims mounted on the vehicle.
- Determine the condition of the road or the path that is under water and if there are any obstacles in the way before driving through the standing water.
- Do not exceed 5 mph (8 km/h) when driving through standing water. This will minimize wave effects.
- Driving through standing water may cause damage to your vehicle's drivetrain components. Always inspect your vehicle's fluids (i.e., engine oil, transmission, axle, etc.) for signs of contamination (i.e., fluid that is milky or foamy in appearance) after driving through standing water. Do not continue to

(Continued)

CAUTION!

operate the vehicle if any fluid appears contaminated, as this may result in further damage. Such damage is not covered by the New Vehicle Limited Warranty.

- Getting water inside your vehicle's engine can cause it to lock up and stall out, and cause serious internal damage to the engine. Such damage is not covered by the New Vehicle Limited Warranty.

MULTIMEDIA

UCONNECT SYSTEMS

For detailed information about your Uconnect 5 With 7-inch Display or Uconnect 5 NAV With 10.1-inch Display system, refer to your Uconnect Radio Instruction Manual.

NOTE:

Uconnect screen images are for illustration purposes only and may not reflect exact software for your vehicle.

CYBERSECURITY

Depending on applicability, your vehicle may be able to send or receive information from a wired or wireless network. This information allows systems and features in your vehicle to function properly.

Your vehicle may be equipped with certain security features to reduce the risk of unauthorized and unlawful access to vehicle systems and wireless communications. Vehicle software technology continues to evolve over time and FCA US LLC, working with its suppliers, evaluates and takes appropriate steps as needed. As always, if you experience unusual behavior, contact an authorized dealer immediately, ↩ page 266, or refer to your Uconnect Radio Instruction Manual for additional contact information.

The risk of unauthorized and unlawful access to your vehicle systems may still exist, even if the most recent version of vehicle software (such as Uconnect software) is installed.

WARNING!

- ONLY insert trusted devices/components into your vehicle. Media of unknown origin could possibly contain malicious software, and if installed in your vehicle, it may increase the possibility for vehicle systems to be breached.
- As always, if you experience unusual vehicle behavior, take your vehicle to an authorized dealer immediately.

NOTE:

To help further improve user experience, features, stability, etc., and minimize the potential risk of a security breach, vehicle owners should routinely check www.driveuconnect.com (US Residents) or www.driveuconnect.ca (Canadian Residents) to learn about available Uconnect software updates.

UCONNECT SETTINGS

The Uconnect system uses a combination of buttons on the touchscreen and buttons on the faceplate located on the center of the instrument panel. These buttons allow you to access and change the customer programmable features. Many features can vary by vehicle.

Buttons on the faceplate are located below and/or beside the Uconnect system in the center of the instrument panel. In addition, there is a SCROLL/ENTER control knob located on the right side. Turn the control knob to scroll through menus and change settings. Push the center of the control knob one or more times to select or change a setting.

Your Uconnect system may also have SCREEN OFF and MUTE buttons on the faceplate.

Push the SCREEN OFF button on the faceplate to turn off the Uconnect screen. Push the button again or tap the screen to turn the screen on.

Press the Back Arrow button to exit out of a Menu or certain option on the Uconnect system.

Push and hold the Power button on the radio's faceplate for a minimum of 15 seconds to reset the radio.

CUSTOMER PROGRAMMABLE FEATURES



Uconnect 5 NAV With 10.1-inch Display Buttons On The Touchscreen And Buttons On The Faceplate

- 1 — Uconnect Buttons On The Touchscreen
2 — Uconnect Buttons On The Faceplate

For The Uconnect 5 With 7-inch Display And The Uconnect 5 NAV With 10.1-inch Display

Press the Vehicle button, then press the Settings tab on the top of the touchscreen. In this menu, the Uconnect system allows you to access all of the available programmable features.

NOTE:

- Only one touchscreen area may be selected at a time.
- Depending on the vehicle's options, feature settings may vary.

When making a selection, press the button on the touchscreen to enter the desired menu. Once in the desired menu, press and release the preferred setting option until a check mark appears next to the setting, showing that setting has been selected. Once the setting is complete, press the Vehicle button to exit to the screen. Pressing the Up or Down Arrow button on the right side of the screen will allow you to toggle up or down through the available settings.

Display

When the Display button is pressed on the touchscreen, the system will display the options related to the theme (if equipped), brightness, and color of the touchscreen. The available settings are:

NOTE:

Depending on the vehicle's options, feature settings may vary.

Setting Name	Description
Language	This setting will change the language of the Uconnect system and Instrument Cluster Display. The available languages are English, French, Spanish, and Italiano.
Display Mode	This setting will allow you to set the brightness manually or have the system set it automatically. The "Auto" setting has the system automatically adjust the display brightness. The "Manual" setting will allow the user to adjust the brightness of the display.

Setting Name	Description
Display Brightness Nighttime	This setting will allow you to set the brightness when the headlights are on. To access this setting, Display Mode must be set to Manual. The "+" setting will increase the brightness; the "-" will decrease the brightness.
Display Brightness Daytime	This setting will allow you to set the brightness when the headlights are off. To access this setting, Display Mode must be set to Manual. The "+" setting will increase the brightness; the "-" will decrease the brightness.
Set Theme	This setting will allow you to change the display theme.
Units	This setting will allow you to change the units. The available options are "Speed" (MPH or km/h), "Distance" (mi or km), "Current Consumption" (MPG [US], MPG [UK], L/100 km, or km/L), "Pressure" (psi, kPa, or bar) and "Temperature" (°C or °F) units of measurement independently.
Theme Mode	This setting will allow you to adjust the brightness of your theme. Setting options are "Light", "Dark" and "Auto". Select to show themes in Light or Dark mode. "Auto" changes the theme with the headlights.
Touchscreen Beep	This setting will allow you to turn the touchscreen beep on or off.
Show Main Category Bar Labels	This setting will allow you to turn the bottom main category bar labels on or off.
Navigation Next Turn Pop-ups Displayed in Cluster	This setting will display Navigation prompts in the Instrument Cluster Display.
Phone Pop-ups Displayed In Cluster	This setting will display smartphone notifications and messages in the Instrument Cluster Display.

My Profile

When the My Profile button is pressed on the touchscreen, the system displays options related to the vehicle's profiles.

NOTE:

Depending on the vehicle's options, feature settings may vary.

Setting Name	Description
Language	This setting will change the language of the Uconnect system and Instrument Cluster Display. The available languages are English, French, Spanish, and Italiano.
Display Mode	This setting will adjust the display for the radio to "Auto" or "Manual". "Manual" allows for more customization with the radio display.
Display Brightness Nighttime	This setting will allow you to set the brightness when the headlights are on. To access this setting, Display Mode must be set to "Manual". The "+" setting will increase the brightness; the "-" will decrease the brightness.

Setting Name	Description
Display Brightness Daytime	This setting will allow you to set the brightness when the headlights are off. To access this setting, Display Mode must be set to "Manual". The "+" setting will increase the brightness; the "-" will decrease the brightness.
Set Theme	This setting will allow you to change the display theme.
Units	This setting will allow you to change the units. The available options are "Speed" (MPH or km/h), "Distance" (mi or km), "Current Consumption" (MPG [US], MPG [UK], L/100 km, or km/L), "Pressure" (psi, kPa, or bar), and "Temperature" (°C or °F) units of measurement independently.
Theme Mode	This setting will allow you to adjust the brightness of your theme. Setting options are "Light", "Dark" and "Auto". Select to show themes in Light or Dark mode. "Auto" changes the theme with the headlights.
Touchscreen Beep	This setting will allow you to turn the touchscreen beep on or off.
Show Main Category Bar Labels	This setting will allow the main category bar labels to be shown on or off.
Navigation Turn-by-Turn Displayed in Cluster	This setting will display Navigation prompts in the Instrument Cluster Display.
Time Format	This setting will allow you to set the time format (AM/PM). Sync Time With GPS must be "Off" for this setting to be available. The "12 hrs" setting will set the time to a 12-hour format. The "24 hrs" setting will set the time to a 24-hour format.
Voice Options	This setting will allow you to change the voice options for the radio to "Male" or "Female".
Wake Up Word	This setting will allow you to set the system "Wake Up" word. The available options are "Off", "Hey, Uconnect", and "Hey, Ram".
Voice Barge-in	This setting will allow Voice Barge-in to be turned on or off. For more information about Voice Barge-in, refer to your Uconnect Radio Instruction Manual.
Show Command List	This setting will allow the Command List on the Voice Recognition window to be shown on or off.
Radio Off Delay	This setting will keep certain electrical features running after the engine is turned off. When any door is opened, the electronics will deactivate. The available settings are "0 sec", "45 sec", "5 min", and "10 min".
Radio Off With Door	This setting will allow you to determine if the radio shuts off when any of the doors are opened.
App Drawer Favoriting Pop-ups	This setting will allow you to favorite app drawer pop-ups with "On" and "Off" options.
App Drawer Unfavoritings Pop-ups	This setting will allow you to unfavorite app drawer pop-ups with "On" and "Off" options.
New Text Message Pop-ups	This setting will allow you to have pop-up notifications for new text messages. Setting options are "On" and "Off".
Missed Calls Message	This setting will allow you to have pop-up notifications for missed calls. Setting options are "On" and "Off".
Navigation Pop-ups	This setting will allow you to have pop-up notifications for Navigation. Setting options are "On" and "Off".
Navigation Settings	This setting will redirect to the list of Navigation settings. Refer to your Uconnect Radio Instruction Manual for further information.

Setting Name	Description
Audio Settings	This setting will open the submenu, containing the audio settings ↗ page 147.
Reset App Drawer to Default Order	This setting will reset the app drawer to its factory default layout.
Restore Settings to Default	This setting will return all the previously changed settings to their factory defaults.
More Profile Options	This setting will give access to more profile options.

Safety & Driving Assistance

When the Safety & Driving Assistance button is pressed on the touchscreen, the system displays the options related to the vehicle's safety settings. These options will differ depending on the features equipped on the vehicle. The settings may display in list form or within subfolders on the screen. To access a subfolder, select the desired folder; the available options related to that feature will then display on the screen.

NOTE:

Depending on the vehicle's options, feature settings may vary.

Setting Name	Description
Forward Collision Sensitivity — Located In Automatic Emergency Braking Submenu	This setting will turn the Forward Collision Warning (FCW) system on or off. The "Off" setting will deactivate the FCW system. The "Warning Only" setting will provide only an audible chime when a collision is detected. The "Warning + Active Braking" setting will provide an audible chime and apply some brake pressure when a collision is detected.
Forward Collision Warning — Located In Automatic Emergency Braking Submenu	This setting will turn the Forward Collision Warning system on or off. The "Off" setting will deactivate the FCW system. The "Warning Only" setting will provide only an audible chime when a collision is detected. The "Warning + Active Braking" setting will provide an audible chime and apply some brake pressure when a collision is detected.
Emergency Vehicle Detection Alerts	This setting will turn alerts on or off for detecting an emergency vehicle near you.
Traffic Sign Assist	This setting will turn Traffic Sign Assist on or off.
Traffic Sign Assist Warning	This setting will allow you to set the warning type related to the traffic sign. The available options are "Off", "Visual", and "Visual + Chime".
New Speed Zone Indication	This setting will allow you to set if the system will warn you that the speed limit has changed in an area. The available options are "Off", "Visual", and "Visual + Chime".
LaneSense Warning	This setting will set the warning type for LaneSense. The available options are "Early", "Medium", and "Late".
LaneSense Strength	This setting will set the strength of the LaneSense system. The available options are "Low", "Medium", and "High".

Setting Name	Description
Side Distance Warning	This setting will turn the Side Distance Warning on or off. The "Off" setting will deactivate the system. The "On" setting will provide both an audible chime and a visual display.
ParkSense	This setting will change the type of ParkSense alert when a close object is detected. The available options are "Sound" which provides only an audible chime and "Sounds & Display" which provides both a sound and a visual display.
Front ParkSense Volume	This setting adjusts the volume of the Front ParkSense system. The available settings are "Low", "Medium", and "High".
Rear ParkSense Volume	This setting adjusts the volume of the Rear ParkSense system. The available settings are "Low", "Medium", and "High".
Drowsy Driver Alert	This setting will monitor the driver's driving habits and warn you of any changes, indicating that the driver may be drowsy. The available options are "On" and "Off".
Blind Spot Alert	This setting will change the type of alert provided when an object is detected in a vehicle's blind spot. The "Off" setting will turn off Blind Spot Alert. The "Lights" setting will activate the Blind Spot Alert lights on the outside mirrors. The "Lights & Chime" setting will activate the lights on the outside mirrors and an audible chime.
Trailer Length For Blind Spot Alert	This setting will detect the length of a trailer. "Auto" will automatically detect the length. "Max" sets all trailers to 39.5 ft (12 m).
Intelligent Speed Options	This setting will let you customize your intelligent speed options. Selectable options are "Manual Confirm" and "Auto Confirm".

Clock & Date

When the Clock & Date button is pressed on the touchscreen, the system displays the different options related to the vehicle's internal clock.

NOTE:

Depending on the vehicle's options, feature settings may vary.

Setting Name	Description
Sync Time With GPS	This setting will sync the time to the GPS receiver in the system. The system will control the time via the GPS location.
Set Time	This setting will allow you to set the hours and minutes. Sync Time With GPS must be off for this setting to be available. The "+" setting will increase the hours and minutes. The "-" setting will decrease the hours and minutes.
Time Format	This setting will allow you to set the time format (AM/PM). Sync Time With GPS must be off for this setting to be available. The "12 hrs" setting will set the time to a 12-hour format. The "24 hrs" setting will set the time to a 24-hour format.
Show Time in Status Bar	This setting will place the time in the radio's status bar.
Set Date	This setting will allow you to set the day, month and year. Using "+" or "-", you can scroll through the available days, months, and years.

Setting Name	Description
Show Time and Date During Screen Off	This setting will allow you to show the time and date while the screen is off. Available options are "On" and "Off".

Phone/Bluetooth®

When the Phone/Bluetooth® button is pressed on the touchscreen, the system displays the options related to Bluetooth® connectivity from an external audio device or smart-phone. The list of paired audio devices or smartphones can be accessed from this menu.

NOTE:

Depending on the vehicle's options, feature settings may vary.

Setting Name	Description
Device Manager	This setting will open the Device Manager main screen.
Do Not Disturb All	This setting will open the Do Not Disturb All settings menu. The available options are "On" and "Off".
Enable Two Active Phones	This setting will enable or disable two active phones with the vehicle. The setting options are "On" and "Off".
Phone Pop-Ups Displayed In Cluster	This setting will activate phone message pop-ups in the Instrument Cluster Display.

Voice

When the Voice button is pressed on the touchscreen, the system displays the options related to the vehicle's Voice Recognition feature.

NOTE:

Depending on the vehicle's options, feature settings may vary.

Setting Name	Description
Voice Options	This setting will allow you to change the system's voice to either "Male" or "Female".
Wake Up Word	This setting will allow you to set the system's "Wake Up" word. The available options are "Off", "Hey, Uconnect", and "Hey, Ram".
Voice Barge-In	This setting allows you to respond to a Voice Response before the statement is completed by the system. The available options are "On" and "Off".

Setting Name	Description
Show Command List	This setting will allow you to turn the Command List on or off. The “Always” setting will always show the Command List. The “With Help” setting will show the Command List and provide a brief description of what the command does. The “Never” setting will turn the Command List off.

Navigation — If Equipped

When the Navigation button is pressed on the touchscreen, the system displays options related to the vehicle’s built-in Navigation system. These settings can change which icons display on the map, how “time to arrival is calculated”, and route types.

For more information on Navigation and settings, refer to your Uconnect Radio Instruction Manual.

NOTE:

Depending on the vehicle’s options, feature settings may vary.

Camera

When the Camera button is pressed on the touchscreen, the system displays the options related to the vehicle’s camera features.

NOTE:

Depending on the vehicle’s options, feature settings may vary.

Setting Name	Description
Surround View Camera Delay	This setting will add a timed delay to the Surround View Camera when shifting out of REVERSE.
Surround View Camera Guidelines	This setting will turn the Surround View Camera Guidelines on or off.
ParkView Backup Camera Delay	This setting will add a timed delay to the ParkView Backup Camera when shifting out of REVERSE.
ParkView Backup Camera Active Guidelines	This setting will turn the ParkView Backup Camera Active Guidelines on or off.

Mirrors & Wipers

When the Mirrors & Wipers button is pressed on the touchscreen, the system displays the options related to the vehicle's mirrors and wipers.

NOTE:

Depending on the vehicle's options, feature settings may vary.

Setting Name	Description
Rain Sensing Auto Wipers	This setting will turn the Rain Sensing Auto Wipers on or off.
Headlights with Wipers	This setting will turn the headlights on when the wipers are activated.

Lights

When the Lights button is pressed on the touchscreen, the system displays the options related to the vehicle's exterior and interior lights.

NOTE:

- When the "Daytime Running Lights" feature is selected, the daytime running lights can be turned on or off. This feature is only allowed by law in the country of the vehicle purchase.
- Depending on the vehicle's options, feature settings may vary.

Setting Name	Description
Headlight Off Delay	This setting will allow you to set the amount of time it takes for the headlights to shut off after the vehicle is turned off. The available settings are "0 sec", "30 sec", "60 sec", and "90 sec".
Greeting Lights	When the "Greeting Lights" feature is selected, it allows the adjustment of the amount of time the headlights remain on after the doors are unlocked with the key fob. The available settings are "0 sec", "30 sec", "60 sec", and "90 sec".
Auto Dim High Beams	This setting will allow you to turn the Auto Dim High Beams on or off.
Daytime Running Lights	This setting will allow you to turn the Daytime Running Lights on or off.
Cornering Lights	When this setting is selected, if the steering wheel rotation angle is large or the turn signal indicators are on, a light (incorporated in the fog light) will turn on, on the relevant side to improve visibility at night.
Flash Lights With Lock	This setting will allow you to turn the flashing of the lights when the Lock button is pushed on the key fob on or off.
Headlights with Wipers	This setting will turn the headlights on when the wipers are activated.

Setting Name	Description
Headlight Sensitivity	This setting will allow you to set the sensitivity of the headlights dependent on the amount of visible light. The greater the sensitivity set, the less the external light variation required to turn on the lights (e.g. with a setting on level 3 at sunset, the headlights turn on earlier than in levels 1 and 2). The available levels are “Level 1: Minimum Sensitivity”, “Level 2: Medium Sensitivity”, and “Level 3: Maximum Sensitivity”.

Brakes

When the Brakes button is pressed on the touchscreen, the system will display the settings related to the vehicle's brake system.

NOTE:

Depending on the vehicle's options, feature settings may vary.

Setting Name	Description
Auto Park Brake	This setting will turn the Auto Park Brake on or off.
Brake Service	This setting will allow you to set the brakes for service. When the setting is selected, a pop-up will display with “Yes” and “No” options.
Hold 'n Go	This setting will turn the Hold 'n Go on or off.

5

Doors & Locks

When the Doors & Locks button is pressed on the touchscreen, the system displays the options related to locking and unlocking the vehicle's doors.

NOTE:

Depending on the vehicle's options, feature settings may vary.

Setting Name	Description
Auto Door Locks	This setting will allow you to change if the doors lock automatically when the vehicle reaches 20 mph (32 km/h).
Auto Unlock On Exit	This setting will unlock the doors when any of the doors are opened from the inside.
Flash Lights With Lock	This setting will allow you to turn the flashing of the lights when the Lock button is pushed on the key fob on or off.

Setting Name	Description
Sound Horn With Lock	This setting will sound the horn when the Lock button is pushed on the key fob. The "Off" setting will not sound the horn when the Lock button is pushed. The "1st Press" setting will sound the horn when the Lock button is pushed once. The "2nd Press" setting will sound the horn when the Lock button is pushed twice.
Sound Horn With Remote Start	This setting will sound the horn when the remote start is activated from the key fob.
Remote Door Unlock, Door Lock/1st Press Of Key Fob Unlocks	This setting will change how many pushes of the Unlock button on the key fob are needed to unlock all the doors. The "Driver Door" setting will only unlock the driver door on the first push on the Unlock button. The "All Doors" setting will unlock all doors with only one push of the Unlock button.
Passive Entry	This setting will allow you to turn the Passive Entry feature (Keyless Enter 'n Go™) between "Off", "All", and "Approach".

Key Off Options

When the Key Off Options Options button is pressed on the touchscreen, the system displays the options related to vehicle shutoff. These settings will only activate when the ignition is set to OFF.

NOTE:

Depending on the vehicle's options, feature settings may vary.

Setting Name	Description
Radio Off Delay	This setting will keep the radio on for the selected amount of time after vehicle shut off. The available options are "0 min" and "20 min".
Radio Off with Door	This setting will keep the radio on when a door is opened or until the Radio Off Delay time is reached. The available settings are "On" and "Off".
Headlight Off Delay	This setting will allow you to set the amount of time the headlights remain on after the vehicle has been turned off. The available settings are "0 sec", "30 sec", "60 sec", and "90 sec".

Audio

When the Audio button is pressed on the touchscreen, the system displays options related to the vehicle's sound system. These settings can change the audio location within the vehicle, adjust the bass or treble levels, and auto-play settings from an audio device or smartphone.

NOTE:

Depending on the vehicle's options, feature settings may vary.

Setting Name	Description
Balance	This setting will adjust audio levels from specific speakers in the front/back and left/right of the vehicle. The Speaker icon can be moved to set audio location.
Equalizer	This setting will adjust the "Bass", "Mid", and "Treble" ranges of the audio.
Speed Adjusted Volume	This setting will adjust audio volume as speeds increase. At a higher setting, the volume will increase more as the vehicle speeds up. The available settings are "Off", "1", "2", and "max".
Surround Sound	This setting will turn the Surround Sound system on or off.
Auto Play	This setting will automatically begin playing audio from a connected device.
Auto-On Radio	This setting will automatically turn the radio on when the vehicle is started. The available settings are "Off", "On", and "Recall Last". With "Recall Last", the system resumes the previous task before vehicle shut off.
Radio off With Door	This setting will keep the radio on when a door is opened or until the Radio Off Delay time is reached. The available settings are "On" and "Off".
Volume Adjustment	This setting will allow you to set the audio volume levels for each option (Media, Phone, Navigation, etc.). You can set the volume between 0 and 38.

Notifications

When the Notifications button is pressed on the touchscreen, the system displays the options related to Notifications for the system.

NOTE:

Depending on the vehicle's options, feature settings may vary.

Setting Name	Description
Notification Sounds	Turn this setting on or off to hear notification sounds throughout your system.
App Drawer Favoriting Pop-Ups	This setting turns the App Favorited pop-up on or off.
App Drawer Unfavoriting Pop-Ups	This setting turns the App Unfavorited pop-up on or off.
New Text Message Pop-Ups	This setting turns receiving/storing a pop-up for new text messages from any connected phone on or off.
Missed Calls Message	This setting turns receiving/storing a pop-up for missed calls from any connected phone on or off.
Navigation Pop-Ups	This setting turns receiving/storing predictive Navigation Pop-Ups on or off.

SiriusXM® Setup

When the SiriusXM® Setup button is pressed on the touchscreen, the system displays the options related to SiriusXM® satellite radio. These settings can be used to skip specific radio channels and restart favorite songs from the beginning.

NOTE:

- A subscription to SiriusXM® satellite radio is required for these settings to be functional.
- Depending on the vehicle's options, feature settings may vary.

Setting Name	Description
SiriusXM® Account, Profile, And Settings	This setting will redirect you to the SiriusXM® Settings menu within the SiriusXM® menu.
Block Explicit	This setting will skip over content labeled as explicit. The available settings are "On" and "Off".

Software Updates

When the Software Updates button is pressed on the touchscreen, the system will display the setting related to updating the Uconnect software.

NOTE:

Depending on the vehicle's options, feature settings may vary.

Setting Name	Description
Software Downloads over Wi-Fi	This setting will allow software updates to happen over Wi-Fi. Selectable options for the setting are "On" and "Off".

System Information

After pressing the System Information button on the touchscreen, the following settings will be available:

NOTE:

Depending on the vehicle's options, feature settings may vary.

Setting Name	Description
Software License	When this feature is selected, a "Software License" screen will appear, displaying the system software version.
Version Information	When this feature is selected, a Version Information screen will appear, displaying information about the version of your radio.
License Information	When this feature is selected, a License Information screen will appear, displaying the licensing information of your radio.

Reset

When the Reset button is pressed on the touchscreen, the system displays the options related to resetting the Uconnect system back to its default settings. These settings can clear personal data and reset selected settings from other menus.

NOTE:

Depending on the vehicle's options, feature settings may vary.

Setting Name	Description
Restart Radio	This setting will reboot the radio.
Reset Apps Drawer To Default Order	This setting will return the apps drawer to the default order. The available options are "Yes" and "Cancel". The X button can also be pressed to cancel the screen.
Restore Settings to Default	This setting will return all the previously changed settings to their factory defaults.

Setting Name	Description
Clear Personal Data	This setting will display a pop-up that gives you the option to clear all personal data from the system, including Bluetooth® devices and presets.
Reset Wi-Fi Password For Projection	This setting will allow you to reset the vehicle's Wi-Fi password for smartphone projection. The available options are "Yes" and "Cancel". The X button can also be pressed to cancel the screen.
Factory Reset	This setting will restore the radio to its factory default settings.
Reset Performance Values	This setting will reset the performance values from your vehicle.

RADIO OPERATION AND MOBILE PHONES

Under certain conditions, the mobile phone being on in your vehicle can cause erratic or noisy performance from your radio. This condition may be lessened or eliminated by relocating the mobile phone antenna. This condition is not harmful to the radio. If your radio performance does not satisfactorily clear from repositioning of the antenna, it is recommended that the volume be turned down or off during mobile phone operation when not using the Uconnect (if equipped).

REGULATORY AND SAFETY INFORMATION

US/CANADA

Exposure to Radio Frequency Radiation

The radiated output power of the internal wireless radio is far below the FCC and IC radio frequency exposure limits. Nevertheless, the wireless radio will be used in such a manner that the radio is 8 inches (20 cm) or further from the human body.

The internal wireless radio operates within guidelines found in radio frequency safety standards and recommendations, which reflect the consensus of the scientific community.

The radio manufacturer believes the internal wireless radio is safe for use by consumers. The level of energy emitted is far less than the electromagnetic energy emitted by wireless devices such as mobile phones. However, the use of wireless radios may be restricted in some situations or environments, such as aboard airplanes. If you are unsure of restrictions, you are encouraged to ask for authorization before turning on the wireless radio ↩ page 269.

MPEG LICENSE AGREEMENT

This product is licensed under the AVC patent portfolio license for the personal and noncommercial use of a consumer to:

1. Encode video in compliance with the AVC standard ("AVC video") and/or
2. Decode AVC video that was encoded by a consumer engaged in a personal and non-commercial activity and/or was obtained from a video provider licensed to provide AVC video

No license is granted or shall be implied for any other use.

Additional information may be obtained from MPEG LA, L.L.C.

See <http://www.mpegla.com>

SAFETY

SAFETY FEATURES

ANTI-LOCK BRAKE SYSTEM (ABS)

The ABS is designed to aid the driver in maintaining vehicle control under adverse braking conditions. The system operates with a separate computer to modulate hydraulic pressure, to prevent wheel lock-up and to help avoid skidding on slippery surfaces.

The system's pump motor runs during an ABS stop to provide regulated hydraulic pressure. The pump motor makes a low humming noise during operation, which is normal.

The ABS includes an yellow ABS Warning Light. When the light is illuminated, the ABS is not functioning. The system reverts to standard non-ABS. Placing the ignition in the OFF mode and to the ON mode again may reset the ABS if the fault detected was only momentary.

WARNING!

- The ABS contains sophisticated electronic equipment that may be susceptible to interference caused by improperly installed or high output radio transmitting equipment. This interference can cause possible loss of anti-lock braking capability. Installation of such equipment should be performed by qualified professionals.

(Continued)

WARNING!

- Pumping of the Anti-Lock Brakes will diminish their effectiveness and may lead to a collision. Pumping makes the stopping distance longer. Just press firmly on your brake pedal when you need to slow down or stop.
- The ABS cannot prevent the natural laws of physics from acting on the vehicle, nor can it increase braking or steering efficiency beyond that afforded by the condition of the vehicle brakes and tires or the traction afforded.
- The ABS cannot prevent collisions, including those resulting from excessive speed in turns, following another vehicle too closely, or hydroplaning.
- The capabilities of an ABS equipped vehicle must never be exploited in a reckless or dangerous manner that could jeopardize the user's safety or the safety of others.

When you are in a severe braking condition involving the use of the ABS, you will experience some pedal drop as the vehicle comes to a stop. This is the result of the system reverting to the base brake system.

Engagement of the ABS may be accompanied by a pulsing sensation. You may also hear a clicking noise. These occurrences are normal and indicate that the system is functioning properly.

REGENERATIVE BRAKING SYSTEM (RBS) — BEV (IF EQUIPPED)

The RBS replenishes the vehicle's high voltage battery during deceleration, and is particularly useful in stop-and-go city traffic. The electric motors that propel the vehicle forward can operate as generators when braking. The RBS recharges the high voltage battery under certain braking conditions by recapturing energy that would otherwise be lost while braking. The electric power that is generated goes back into the high voltage battery for later use, for example, when acceleration is desired.

The RBS uses conventional hydraulic friction brakes, regenerative braking, or a combination to slow the vehicle. If the system detects slippery conditions while braking, ONLY friction is used to slow the vehicle. The RBS can result in extended life of the hydraulic service brakes; however, all inspection, scheduled maintenance, and service intervals for the vehicle brakes must be followed.

AUDIBLE PEDESTRIAN WARNING SYSTEM — BEV (IF EQUIPPED)

Your vehicle is equipped with an Audible Pedestrian Warning system. The Audible Pedestrian Warning system uses distinct sounds to alert pedestrians that your vehicle is approaching. In addition, the module will indicate changes in vehicle speed by varying the relative volume.

The system uses an in-vehicle sound synthesizer with two external speakers. One is located in the under-hood compartment and the other is in the rear of the vehicle. The Audible Pedestrian Warning system is active when the vehicle is not in PARK and is stopped or traveling at lower speeds. Depending on the selected gear (REVERSE, DRIVE, LOW or NEUTRAL), the system activates the corresponding speaker location based on the intended direction of travel.

WARNING!

The Audible Pedestrian Warning system is not intended to avoid a collision. It is always the driver's responsibility to be attentive to the vehicle's distance between other vehicles, people, and objects, and most importantly brake operation to ensure safe operation of the vehicle under all road conditions. Your complete attention is always required while driving to maintain safe control of your vehicle. Failure to follow this warning could result in a collision or serious personal injury.

ELECTRONIC BRAKE CONTROL (EBC) SYSTEM

Your vehicle is equipped with an advanced Electronic Brake Control (EBC) system that includes the Brake Assist System (BAS), Crosswind Assist (CWA), Electronic Stability Control (ESC), Hill Start Assist (HSA), Traction Control System (TCS), and Trailer Sway Control (TSC). These systems complement the Anti-Lock Brake System (ABS) by optimizing the vehicle braking capability during emergency braking maneuvers.

Brake Assist System (BAS)

The BAS is designed to optimize the vehicle's braking capability during emergency braking maneuvers. The system detects an emergency braking situation by sensing the rate and amount of brake application and then applies optimum pressure to the brakes. This can help reduce braking distances. The BAS complements the Anti-Lock Brake System (ABS). Applying the brakes very quickly results in the best BAS assistance. To receive the benefit of the system, you must apply continuous braking pressure during the stopping sequence (do not "pump" the brakes). Do not reduce brake pedal pressure unless braking is no longer desired. Once the brake pedal is released, the BAS is deactivated.

WARNING!

The Brake Assist System (BAS) cannot prevent the natural laws of physics from acting on the vehicle, nor can it increase the traction afforded by prevailing road conditions. BAS cannot prevent collisions, including those resulting from excessive speed in turns, driving on very slippery surfaces, or hydroplaning. The capabilities of a BAS-equipped vehicle must never be exploited in a reckless or dangerous manner, which could jeopardize the user's safety or the safety of others.

Crosswind Assist (CWA)

CWA helps keep your vehicle from drifting out of its lane due to unexpected crosswinds by means of targeted braking of individual wheels. The system will provide automatic stability assistance to counteract the effect of strong side wind. If a strong lateral wind is detected, front and rear brakes on the affected side are applied,

creating a steering effect that mitigates the crosswind influence. During system intervention, the driver should perceive the natural stable handling feel of the vehicle.

Crosswind Assist will activate automatically when the vehicle reaches speeds above approximately 43 mph (70 km/h). When the system is activated, the ESC Warning Light in the instrument cluster will blink to warn the driver.

Electronic Roll Mitigation (ERM)

The ERM system anticipates the potential for wheel lift by monitoring the driver's steering wheel input and the speed of the vehicle. When ERM determines that the rate of change of the steering wheel angle and vehicle's speed are sufficient to potentially cause wheel lift, it then applies the appropriate brake and may also reduce engine power to lessen the chance that wheel lift will occur. ERM can only reduce the chance of wheel lift occurring during severe or evasive driving maneuvers; it cannot prevent wheel lift due to other factors, such as road conditions, leaving the roadway, striking objects or other vehicles.

WARNING!

Many factors, such as vehicle loading, road conditions and driving conditions, influence the chance that wheel lift or rollover may occur. ERM cannot prevent all wheel lift or rollovers, especially those that involve leaving the roadway or striking objects or other vehicles. The capabilities of an ERM-equipped vehicle must never be exploited in a reckless or dangerous manner which could jeopardize the user's safety or the safety of others.

Electronic Stability Control (ESC)

ESC enhances directional control and stability of the vehicle under various driving conditions. ESC corrects for over/under steering of the vehicle by applying the brake of the appropriate wheel(s) to counteract the previous conditions listed. Engine power may also be reduced to help the vehicle maintain the desired path.

- Oversteer – when the vehicle is turning more than appropriate for the steering wheel position.
- Understeer – when the vehicle is turning less than appropriate for the steering wheel position.

ESC uses sensors in the vehicle to determine the vehicle path intended by the driver and compares it to the actual path of the vehicle. When the actual path does not match the intended path, ESC applies the brake of the appropriate wheel to assist in counteracting the oversteer or understeer condition.

WARNING!

- Electronic Stability Control (ESC) cannot prevent the natural laws of physics from acting on the vehicle, nor can it increase the traction afforded by prevailing road conditions. ESC cannot prevent accidents, including those resulting from excessive speed in turns, driving on very slippery surfaces, or hydroplaning. ESC also cannot prevent accidents resulting from loss of vehicle control due to inappropriate driver input for the conditions. Only a safe, attentive, and skillful driver can prevent accidents. The capabilities of an ESC equipped vehicle must never be exploited in a reckless or dangerous manner which could jeopardize the user's safety or the safety of others.

(Continued)

WARNING!

- Vehicle modifications, or failure to properly maintain your vehicle, may change the handling characteristics of your vehicle, and may negatively affect the performance of the ESC system. Changes to the steering system, suspension, braking system, tire type and size or wheel size may adversely affect ESC performance. Improperly inflated and unevenly worn tires may also degrade ESC performance. Any vehicle modification or poor vehicle maintenance that reduces the effectiveness of the ESC system can increase the risk of loss of vehicle control, vehicle rollover, personal injury and death.

ESC Operating Modes



The ESC OFF button is located in the center switch bank, next to the hazard flasher switch.

ESC On

This mode is the normal operating mode for ESC equipped vehicles. Whenever the vehicle is started, the ESC system will be in this mode. This mode should be used for most driving situations. ESC should only be turned off for the following specific reasons.

ESC Partial Off

This mode is entered by momentarily pushing the ESC OFF button.

When in the "Partial Off" mode, the TCS portion of ESC, except for the "limited slip" feature described in the TCS section, has been disabled and the ESC OFF Indicator Light will be illuminated. When in the "Partial Off" mode, ESC will operate without engine torque management. This mode is intended to be used if the vehicle is

in deep snow, sand or gravel conditions and more wheel spin than ESC would normally allow is required to gain traction. To turn ESC on again, momentarily push the ESC OFF button. This will restore the normal "ESC On" mode of operation.

WARNING!

- When in "Partial Off" mode, the TCS functionality of ESC, except for the limited slip feature described in the TCS section, has been disabled and the ESC OFF Indicator Light will be illuminated. When in "Partial Off" mode, the engine power reduction feature of TCS is disabled, and the enhanced vehicle stability offered by the ESC system is reduced.
- Trailer Sway Control (TSC) is disabled when the ESC system is in the "Partial Off" mode.

NOTE:

To improve the vehicle's traction when driving with snow chains, or starting off in deep snow, sand or gravel, it may be desirable to switch to the "Partial Off" mode by pushing the ESC OFF button. Once the situation requiring ESC to be switched to the "Partial Off" mode is over, turn ESC back on by momentarily pushing the ESC OFF button. This may be done while the vehicle is in motion.

ESC Activation/Malfunction Indicator Light And ESC OFF Indicator Light



The ESC Activation/Malfunction Indicator Light in the instrument cluster will come on when the ignition is turned to the ON mode. It should go out with the engine running. If the ESC Activation/Malfunction Indicator Light comes

on continuously with the engine running, a malfunction has been detected in the ESC system. If this light remains on after several ignition cycles, and the vehicle has been driven several miles (kilometers) at speeds greater than 30 mph (48 km/h), see an authorized dealer as soon as possible to have the problem diagnosed and corrected.

The ESC Activation/Malfunction Indicator Light starts to flash as soon as the tires lose traction and the ESC system becomes active. The ESC Activation/Malfunction Indicator Light also flashes when TCS is active. If the ESC Activation/Malfunction Indicator Light begins to flash during acceleration, ease up on the accelerator and apply as little throttle as possible. Be sure to adapt your speed and driving to the prevailing road conditions.



The ESC OFF Indicator Light indicates that the Electronic Stability Control (ESC) is in a reduced mode.

NOTE:

- The ESC Activation/Malfunction Indicator Light and the ESC OFF Indicator Light come on momentarily each time the ignition switch is placed in the ON position.
- Each time the ignition is placed in the ON position, the ESC system will be on even if it was turned off previously.
- The ESC system will make buzzing or clicking sounds when it is active. This is normal; the sounds will stop when ESC becomes inactive following the maneuver that caused the ESC activation.

Hill Start Assist (HSA)

The HSA system is designed to assist the driver when starting a vehicle from a stop on a hill. HSA will maintain the level of brake pressure the driver applied for a short period of time after the driver takes their foot off of the brake pedal. If the driver does not apply the throttle during this short period of time, the system will release brake pressure and the vehicle will roll down the hill. The system will release brake pressure in proportion to the amount of throttle applied as the vehicle starts to move in the intended direction of travel.

HSA Activation Criteria

The following criteria must be met in order for HSA to activate:

- The vehicle must be stopped.
- The vehicle must be on a 6% (approximate) grade or greater hill.
- Gear selection matches vehicle uphill direction (i.e., vehicle facing uphill is in forward gear; vehicle backing uphill is in REVERSE gear).

HSA will work in REVERSE and all forward gears when the activation criteria have been met. The system will not activate if the vehicle is placed in NEUTRAL or PARK.

WARNING!

There may be situations on minor hills with a loaded vehicle, or while pulling a trailer, when the system will not activate and slight rolling may occur. This could cause a collision with another vehicle or object. Always remember the driver is responsible for braking the vehicle.

Towing With HSA

HSA will also provide assistance to mitigate roll back while towing a trailer.

WARNING!

- If you use a trailer brake controller with your trailer, the trailer brakes may be activated and deactivated with the brake switch. If so, there may not be enough brake pressure to hold both the vehicle and the trailer on a hill when the brake pedal is released. In order to avoid rolling down an incline while resuming acceleration, manually activate the trailer brake or apply more vehicle brake pressure prior to releasing the brake pedal.
- HSA is not a parking brake. Always apply the parking brake fully when exiting your vehicle. Also, be certain to place the transmission in PARK.
- Failure to follow these warnings can result in a collision or serious personal injury.

Traction Control System (TCS)

TCS monitors the amount of wheel spin of each of the driven wheels. If wheel spin is detected, brake pressure is applied to the slipping wheel(s) and engine power is reduced, to provide enhanced acceleration and stability. A feature of the TCS, Brake Limited Differential (BLD) functions similarly to a limited slip differential and controls the wheel spin across a driven axle. If one wheel on a driven axle is spinning faster than the other, the system will apply the brake of the spinning wheel. This will allow more engine torque to be applied to the wheel that is not spinning. This feature remains active even if the ESC is in the "Partial Off" mode.

The ESC Activation/Malfunction Indicator Light (in the instrument cluster) will start to flash as soon as the tires lose traction and the wheels begin to spin. This indicates that the TCS is active. If the indicator light flashes during acceleration, ease up on the accelerator and apply as little throttle as possible. Be sure to adapt your speed and driving to the prevailing road conditions, and do not switch off the ESC or TCS.

WARNING!

- The TCS cannot prevent the natural laws of physics from acting on the vehicle, nor can it increase the traction afforded.
- The TCS cannot prevent collisions, including those resulting from excessive speed in turns, or hydroplaning.
- The capabilities of a TCS-equipped vehicle must never be exploited in a reckless or dangerous manner, which could jeopardize the user's safety or the safety of others.

Trailer Sway Control (TSC) — If Equipped

TSC uses sensors in the vehicle to recognize an excessively swaying trailer and will take the appropriate actions to attempt to stop the sway. The system may reduce engine power and apply the brake of the appropriate wheel(s) to counteract the sway of the trailer.

NOTE:

TSC cannot stop all trailers from swaying. Always use caution when towing a trailer and follow the trailer tongue weight recommendations ↪ page 128.

When TSC is functioning, the ESC Activation/Malfunction Indicator Light will flash, the engine power may be reduced, and you may feel the brakes being applied to individual wheels to attempt to stop the trailer from swaying. TSC is disabled when the ESC system is in the "Partial Off" mode.

WARNING!

If TSC activates while driving, slow the vehicle down, stop at the nearest safe location, and adjust the trailer load to eliminate trailer sway.

AUXILIARY DRIVING SYSTEMS

BLIND SPOT MONITORING (BSM) — IF EQUIPPED

The BSM system uses two radar sensors, located inside the taillights, to detect highway licensable vehicles (automobiles, trucks, motorcycles, etc.) that enter the blind spot zones from the rear/front/side of the vehicle.

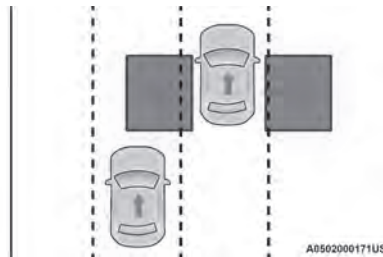

Rear Detection Zones

When the vehicle is started, the BSM Warning Light will momentarily illuminate in both outside rearview mirrors to let the driver know that the system is operational. The BSM system sensors operate when the vehicle is in any forward gear and enters standby mode when the vehicle is in PARK.

The BSM detection zone covers approximately one lane width on both sides of the vehicle 12 ft (3.8 m). The zone length starts at the outside rearview mirror and extends approximately 10 ft (3 m) beyond the rear fascia/bumper of the vehicle. The BSM system monitors the detection zones on both sides of the vehicle when the vehicle speed reaches approximately 6 mph (10 km/h) or higher and will alert the driver of vehicles in these areas.

NOTE:

- The BSM system DOES NOT alert the driver about rapidly approaching vehicles that are outside the detection zones.
- The Blind Spot Monitoring (BSM) system may experience dropouts (blinking on and off) of the side mirror warning indicator lamps when a motorcycle or any small object remains at the side of the vehicle for extended periods of time (more than a couple of seconds).

The vehicle's taillights, where the radar sensors are located, must remain free of snow, ice, and dirt/road contamination so that the BSM system can function properly. Do not block the taillights with foreign objects (bumper stickers, bicycle racks, etc.).



A0503000688US

Radar Sensor Locations

If the system detects degraded performance due to contamination or foreign objects, a message will warn you of a blocked sensor and the warning indicators in the side view mirrors will be on. The warning indicators will remain illuminated until blockage clearing conditions are met. First clear the taillights around the sensors of the blockage. After removing the blockage, the following procedure can be used to reset the system, cycle the ignition from ON to OFF and then back ON.

If the blockage message is still present after cycling the ignition and driving in traffic, check again for a blockage.

The BSM system notifies the driver of objects in the detection zones by illuminating the BSM Warning Light located in the outside mirrors in addition to sounding an audible (chime) alert and reducing the radio volume

➡ page 158.



A0503000687US

Warning Light Location

The BSM system monitors the detection zone from three different entry points (side, rear, front) while driving to see if an alert is necessary. The BSM system will issue an alert during these types of zone entries.

Entering From The Side

Vehicles that move into your adjacent lanes from either side of the vehicle.

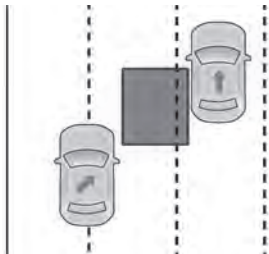

A0502000166US

Side Monitoring

Entering From The Rear

Vehicles that come up from behind your vehicle on either side and enter the rear detection zone with a relative speed of less than 30 mph (48 km/h).

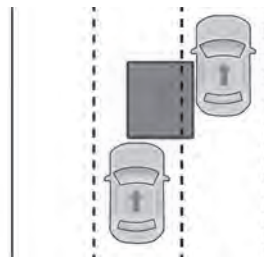

A0502000167US

Rear Monitoring

Overtaking Traffic

If you pass another vehicle slowly with a relative speed less than 15 mph (24 km/h) and the vehicle remains in the blind spot for approximately 1.5 seconds, the warning light will be illuminated. If the difference in speed between the two vehicles is greater than 15 mph (24 km/h), the warning light will not illuminate.

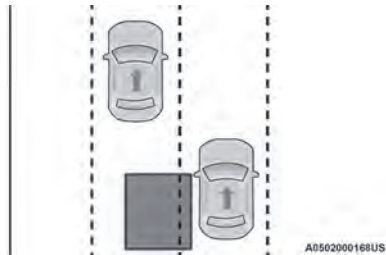

Overtaking/Approaching

A0502000168US

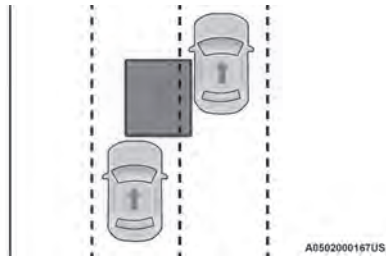

Overtaking/Passing

A0502000167US

The BSM system is designed not to issue an alert on stationary objects such as guardrails, posts, walls, foliage, berms, snow banks, car washes, etc. However, occasionally the system may alert on such objects. This is normal operation and your vehicle does not require service.

The BSM system will not alert you of objects that are traveling in the opposite direction of the vehicle in adjacent lanes → page 269.

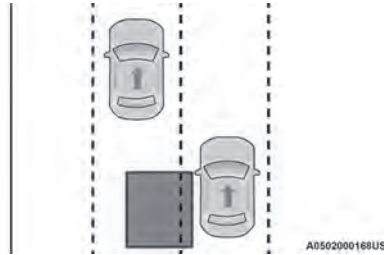

Opposing Traffic

A0502000168US

WARNING!

The Blind Spot Monitoring system is only an aid to help detect objects in the blind spot zones. The BSM system is not designed to detect pedestrians, bicyclists, or animals. Even if your vehicle is equipped with the BSM system, always check your vehicle's mirrors, glance over your shoulder, and use your turn signal before changing lanes. Failure to do so can result in serious injury or death.

Rear Cross Path (RCP)

RCP is intended to aid the driver when backing out of parking spaces where their vision of oncoming vehicles may be blocked. Proceed slowly and cautiously out of

the parking space until the rear end of the vehicle is exposed. The RCP system will then have a clear view of the cross traffic, and if an oncoming vehicle is detected, alert the driver.

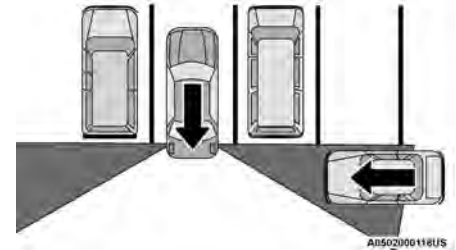

RCP Detection Zones

A05020001168US

RCP monitors the rear detection zones on both sides of the vehicle, for objects that are moving toward the side of the vehicle with a minimum speed of approximately 3 mph (5 km/h), to objects moving a maximum of approximately 20 mph (32 km/h), such as in parking lot situations.

When RCP is on and the vehicle is in REVERSE (R), the driver is alerted using both the visual and audible alarms, including reducing the radio volume.

NOTE:

In a parking lot situation, oncoming vehicles can be blocked by vehicles parked on either side. If the sensors are blocked by other structures or vehicles, the system will not be able to alert the driver.

WARNING!

Rear Cross Path Detection (RCP) is not a backup aid system. It is intended to be used to help a driver detect an oncoming vehicle in a parking lot situation. Drivers must be careful when backing up, even when using RCP. Always check carefully behind your vehicle, look behind you, and be sure to check for pedestrians, animals, other vehicles, obstructions, and blind spots before backing up. Failure to do so can result in serious injury or death.

Blind Spot Modes

Blind Spot has three selectable modes of operation that are available in the Uconnect system.

Blind Spot Alert Lights Only

When operating in Blind Spot Alert mode, the BSM system will provide a visual alert in the appropriate side view mirror based on a detected object. However, when the system is operating in Rear Cross Path (RCP) mode, the system will respond with both visual and audible alerts when a detected object is present. Whenever an audible alert is requested, the radio is muted.

Blind Spot Alert Lights/Chime

When operating in Blind Spot Alert Lights/Chime mode, the BSM system will provide a visual alert in the appropriate side view mirror based on a detected object. If the turn signal is then activated, and it corresponds to an alert present on that side of the vehicle, an audible chime will also be sounded. Whenever a turn signal and detected object are present on the same side at the same time, both the visual and audible alerts will be issued. In addition to the audible alert the radio (if on) will also be muted.

NOTE:

Whenever an audible alert is requested by the BSM system, the radio is also muted.

When the system is in RCP, the system shall respond with both visual and audible alerts when a detected object is present. Whenever an audible alert is requested, the radio is also muted. Turn/hazard signal status is ignored; the RCP state always requests the chime.

Blind Spot Alert Off

When the BSM system is turned off there will be no visual or audible alerts from either the BSM or RCP systems.

NOTE:

The BSM system will store the current operating mode when the vehicle is shut off. Each time the vehicle is started the previously stored mode will be recalled and used.

Trailer Merge Assist — If Equipped

Trailer Merge Assist is a function of the Blind Spot Monitoring (BSM) system that extends the blind spot zone to work while pulling a trailer.

NOTE:

When Trailer Merge Assist is activated, Rear Cross Path is disabled.

Trailer Merge Assist consists of three sub functions:

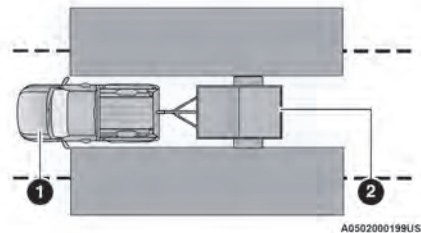

- Automatic Trailer Detection
- Trailer Length Detection
- Trailer Merge Warning

**Blind Spot Zones With Trailer Merge Assist**

- 1 — Vehicle
2 — Trailer

Automatic Trailer Detection

There are two modes of operation for the detection of the trailer length:

- *Automatic Mode* — When “Auto Mode” is selected, the system will use the blind spot sensors to automatically determine the presence and length of a trailer. The presence of a trailer will be detected using the blind spot radar within 90 seconds of forward movement of the vehicle. The vehicle must be moving above 6 mph (10 km/h) to activate the feature. Once the trailer has been detected, the system will default to the maximum blind spot zone until the length has been verified. You will see “Auto” in the instrument panel cluster .
- *Maximum Mode* — When “Max Mode” is selected, the system will default to the maximum blind spot zone regardless of what size trailer is attached .

NOTE:

Selected setting is stored when the ignition is placed in the OFF position. To change this setting, it must be selected through the Uconnect Settings  page 136.

Trailer Length Detection

Once the trailer presence has been established, the trailer length will be established (by making a 90 degree turn) and then the trailer length category (example 10-20 ft (3 m to 6 m)) will be displayed. This can take up to 30 seconds after completing the turn.

NOTE:

During the same ignition cycle, if the vehicle is at a standstill for a minimum of 90 seconds, a new “trailer detection request” is enabled by the system once the vehicle resumes motion.

The maximum trailer length supported by the Trailer Merge Assist feature is 39.5 ft (12 m). Trailer length is considered the forward most portion of the trailer hitch to the rearward most portion of the body, fascia/ bumper, or ramp of the trailer.

The maximum width supported by the Trailer Merge Assist feature is 8.5 ft (2.59 m). Trailer width is measured at the widest portion of the trailer and may include wheels, tires, fenders, or rails.



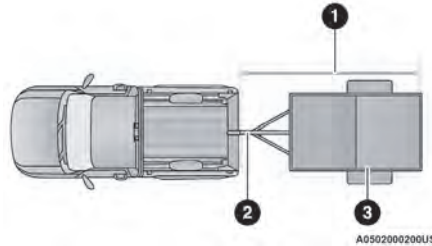

NOTE:

The ability to detect a trailer may be degraded in crowded or busy environments. Busy parking lots, narrow areas surrounded with trees, or any other crowded area may prevent the radar sensors from being able to adequately detect the trailer. The system will try to detect a trailer at every ignition cycle or 90 seconds of standstill.

**Trailer Length Detection**

- 1 – Trailer Length
- 2 – Trailer Hitch
- 3 – Trailer Width

Trailer length will be identified and placed into one of the following categories:

- Trailer length up to 10 ft (3 m) – Blind spot zone will be adjusted to 10 ft (3 m)  .
- Trailer length between 10 ft to 20 ft (3 m to 6 m) – Blind spot zone will be adjusted to 20 ft (6 m) .
- Trailer length between 20 ft to 30 ft (6 m to 9 m) – Blind spot zone will be adjusted to 30 ft (9 m) .
- Trailer length between 30 ft and 39.5 ft (9 m to 12 m) – Blind spot zone will be adjusted to Max distance .

NOTE:

Trailer length is determined within +/- 3 ft (1 m) of actual length. Trailers that are the same size as the category limit, 10/20/30 ft (3/6/9 m), could be subject to being placed in the category above or below the correct one.

Trailer Merge Warning

Trailer Merge Warning is the extension of the blind spot function to cover the length of the trailer, plus a safety margin, to warn the driver when there is a vehicle in the adjacent lane. The driver is alerted by the illumination of the BSM Warning Light located in the outside mirror on the side the other vehicle is detected on. In addition, an audible (chime) alert will be heard and radio volume will be reduced  page 158.

NOTE:

- The Trailer Merge Alert system DOES NOT alert the driver about rapidly approaching vehicles that are outside the detection zones.
- The Blind Spot Monitoring (BSM) system may experience drop outs (blinking on and off) of the side mirror warning indicator lamps when a motorcycle or any small object remains at the side of the vehicle for extended periods of time (more than a couple of seconds).
- Crowded areas such as parking lots, neighborhoods, etc. may lead to an increased amount of false alerts. This is normal operation.

WARNING!

The Blind Spot Monitoring system is only an aid to help detect objects in the blind spot zones. The BSM system is not designed to detect pedestrians, bicyclists, or animals. Even if your vehicle is equipped with the BSM system, always check your vehicle's mirrors, glance over your shoulder, and use your turn signal before changing lanes. Failure to do so can result in serious injury or death.

DROWSY DRIVER DETECTION (DDD) — IF EQUIPPED

DDD detects when the driver is feeling fatigued and warns the driver to pull over and take a break.

To Activate/Deactivate

DDD can be activated and deactivated through the Uconnect system by selecting the following in order:

1. "Safety & Driving Assistance"
2. "Drowsy Driver Detection"

WARNING!

The DDD system is an aid for driving and does not relieve the driver of the responsibility of driving the vehicle. Always drive alert and get plenty of rest before driving. If you experience fatigue while driving, do not wait for the DDD to intervene with a warning. Choose a safe and secure location where you can pull over safely for a break. Only return to the road when you are in the right physical and mental condition to prevent endangering yourself and others.

System Operation

Using feedback obtained from the driver's steering patterns, any buttons/switches that are pressed, and from the front camera, the system implements two operating logics:

- The first operating logic takes the driving style into account, observing the road and detecting to what extent the driver can continue driving with few lane crossing events.
- The second operating logic measures the time spent behind the wheel with the vehicle speed above 40 mph (60 km/h) and below 100 mph (160 km/h).

If the driving style indicates that the driver is unable to follow the road trajectory and respect the horizontal lane markings while within the operating speed range of the system, a pop up will display on the instrument cluster display to suggest that the driver should stop for a break. An audible signal will also sound.

If the driver **accepts** the suggestion provided by the system by pushing the "OK" button on the left side of the steering wheel, the message will disappear from the display.

If the driver **does not acknowledge** the warning, it will be displayed for 60 seconds and then disappear.

NOTE:

In the event of a DDD system failure, a dedicated message will appear in the instrument cluster display.



DDD Warning Message

FORWARD COLLISION WARNING (FCW) WITH MITIGATION — IF EQUIPPED

The FCW with Mitigation system provides the driver with audible warnings, visual warnings (within the instrument cluster display), and may apply a brake jerk to warn the driver when it detects a potential frontal collision. The warnings and limited braking are intended to provide the driver with enough time to react, avoid or mitigate the potential collision.

NOTE:

FCW monitors the information from the forward looking camera as well as the Electronic Brake Controller (EBC), to calculate the probability of a forward collision. When the system determines that a forward collision is probable, the driver will be provided with audible and visual warnings as well as a possible brake jerk warning.

If the driver does not take action based upon these progressive warnings, then the system will provide a limited level of active braking to help slow the vehicle and

mitigate the potential forward collision. If the driver reacts to the warnings by braking and the system determines that the driver intends to avoid the collision by braking but has not applied sufficient brake force, the system will compensate and provide additional brake force as required.

If a FCW with Mitigation event begins at a speed below 26 mph (42 km/h), the system may provide the maximum braking possible to mitigate the potential forward collision. Vehicles With Automatic Transmission: After the end of the intervention of automatic braking, the transmission may remain in last gear stored – therefore the vehicle could lurch forward, once the brakes release a few seconds later. If the Forward Collision Warning with Mitigation event stops the vehicle completely, the system will hold the vehicle at standstill for two seconds and then release the brakes.



FCW Message

When the system determines a collision with the vehicle in front of you is no longer probable, the warning message will be deactivated.

NOTE:

- The minimum speed for FCW activation is 3 mph (5 km/h).
- The FCW alerts may be triggered on objects other than vehicles such as guardrails or sign posts based on the course prediction. This is expected and is a part of normal FCW activation and functionality.
- It is unsafe to test the FCW system. To prevent such misuse of the system the Active Braking portion of FCW will be deactivated for the first 20 seconds from braking actuation.
- The FCW system is intended for on-road use only. If the vehicle is taken off-road, the FCW system should be deactivated to prevent unnecessary warnings to the surroundings.
- FCW may not react to irrelevant objects such as overhead objects, ground reflections, objects not in the path of the vehicle, stationary objects that are far away, oncoming traffic, or leading vehicles with the same or higher rate of speed.
- FCW will be disabled with the unavailable screens [↪ page 269](#).

WARNING!

Forward Collision Warning (FCW) is not intended to avoid a collision on its own, nor can FCW detect every type of potential collision. The driver has the responsibility to avoid a collision by controlling the vehicle via braking and steering. Failure to follow this warning could lead to serious injury or death.

Turning FCW On Or Off

The FCW information is located in the Uconnect display under Automatic Emergency Braking in the control settings [↪ page 136](#).

NOTE:

- Changing the FCW status to “Off” deactivates the system, so no warning or active braking will be available in case of a possible collision.
- Changing the FCW status to “Only Warning” prevents the system from providing limited active braking, or additional brake support if the driver is not braking adequately in the event of a potential frontal collision, but maintains the audible and visual warnings.
- When FCW status is set to “Warning and Braking”, this allows the system to warn the driver of a possible collision with the vehicle in front using audible/visual warnings and it applies autonomous braking.
- The FCW system state is kept in memory from one ignition position to the next. If the system is turned off, it will maintain its status in the next key cycle.

FCW Braking Status And Sensitivity

The FCW Sensitivity and Active Braking status are programmable through the Uconnect system [↪ page 136](#).

- Far
 - When the sensitivity of FCW is set to the “Far” setting and the system status is “Only Warning”, this allows the system to warn the driver of a possible more distant collision with the vehicle in front using audible/visual warnings.
 - More cautious drivers that do not mind frequent warnings may prefer this setting.

NOTE:

The “Far” setting may result in a greater number of FCW possible collision warnings experienced.

- Medium
 - When the sensitivity of FCW is set to the “Medium” setting and the system status is “Only Warning”, this allows the system to warn the driver of a possible collision with the vehicle in front using audible/visual warnings.
- Near
 - When the sensitivity of FCW is set to the “Near” setting and the system status is “Only Warning”, this allows the system to warn the driver of a possible closer collision with the vehicle in front using audible/visual warnings.
 - This setting provides less reaction time than the “Far” and “Medium” settings, which allows for a more dynamic driving experience.
 - More dynamic or aggressive drivers that want to avoid frequent warnings may prefer this setting.

NOTE:

The “Near” setting may result in a lesser number of FCW possible collision warnings experienced.

FCW Limited Warning

If the instrument cluster displays “FCW Limited Functionality Clean Front Windshield” momentarily, there may be a condition that limits FCW functionality. Although the vehicle is still drivable under normal conditions, the active braking may not be fully available. Once the condition that limited the system performance is no longer present, the system will return to its full performance state. If the problem persists, see an authorized dealer.

If the front camera is blocked due to external environmental conditions (i.e. heavy rain, snow, fog), the system will be deactivated and a warning message will display in the instrument cluster.

Service FCW Warning

If the system turns off, and the instrument cluster displays: “FCW Unavailable Service Required”, this indicates there is an internal system fault. Although the vehicle is still drivable under normal conditions, have the system checked by an authorized dealer.

The “FCW Temporarily Unavailable” message can sometimes be displayed while driving in highly reflective areas (i.e. tunnels with reflective tiles, or ice and snow). The system will recover after the vehicle has left these areas. Under rare conditions, when the camera is not tracking any vehicles or objects in its path, this warning may temporarily occur. If weather conditions are not a factor, the driver should examine the fascia/bumper where the camera is located. It may require cleaning or removal of an obstruction from the fascia/bumper cover.

The FCW Warning Light will appear on the instrument cluster to indicate the front camera is obstructed by sun or other visibility reducing weather.

NOTE:

- If the “FCW Temporarily Unavailable” message occurs frequently (e.g. more than once on every trip) without any snow, rain, mud, or other obstruction, have the camera realigned at an authorized dealer.
- Installing a snow plow or front-end protector is not recommended. Doing so may block the camera and inhibit FCW operation.

- Use only a soft cloth for cleaning. Do not use solvents or abrasive pastes.

Precautions While Driving With FCW

In certain driving conditions, such as:

- Driving in the vicinity of a curve
- Small vehicles and/or not aligned to the lane
- Lane changing of other vehicles
- Passing of vehicles in an oncoming intersection

The intervention of the system could be unexpected or delayed. The driver must therefore always pay particular attention, while maintaining control of the vehicle to drive in complete safety.

Driving In The Vicinity Of A Curve

Entering or exiting a large curve, the system could detect the presence of a vehicle that is in front of the vehicle, but that does not reside in the same lane. In cases such as this, the system might respond.

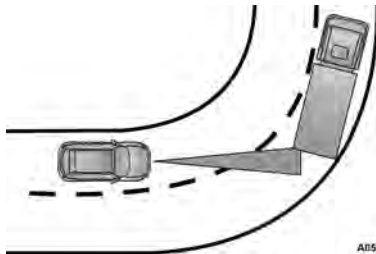

Driving In The Vicinity Of A Curve

Small Vehicles And/Or Not Aligned To The Lane

The system is not able to detect the presence of vehicles that are in front of the vehicle but placed outside the field of action of the camera and could therefore not react in the presence of small vehicles such as bicycles or motorcycles.

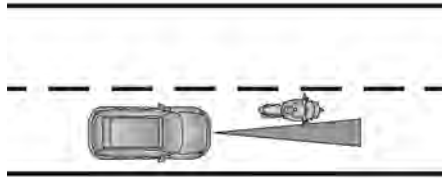

A0502000156U5

Small Vehicles And/Or Not Aligned To The Lane Lane Changing Of Other Vehicles

Vehicles that suddenly change lanes, while staying in the traffic lane of their vehicle and inside the field of action of the camera, may cause the intervention of the system.

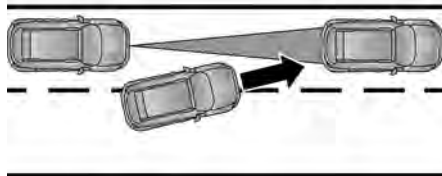

A0502000157U5

Lane Changing Of Other Vehicles

Passing Of Vehicles In An Oncoming Intersection

The system could temporarily react to a vehicle that crossed the range of the camera in an oncoming intersection.

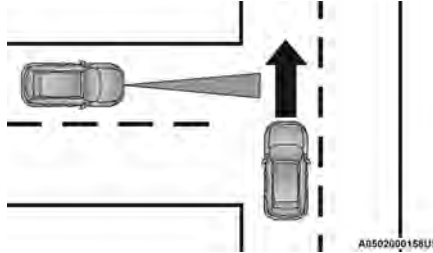

A0502000158U5

Passing Of Vehicles In An Oncoming Intersection

Pedestrian Emergency Braking (PEB) — If Equipped

PEB is a subsystem of the Forward Collision Warning (FCW) system which provides the driver with audible warnings and visual warnings, in the instrument cluster display. It may apply limited automatic braking when it detects a potential frontal collision with a pedestrian/cyclist.



B0502000108U5

PEB Message

If a PEB event begins at a speed below 39 mph (62 km/h), the system may provide maximum braking to mitigate the potential collision with a pedestrian/cyclist. If the PEB event stops the vehicle completely, the system will hold the vehicle at a standstill for two seconds and then release the brakes. When the system determines a collision with the pedestrian/cyclist in front of you is no longer probable, the warning message will be deactivated.

The minimum speed for PEB activation is 3 mph (5 km/h).

WARNING!

Pedestrian Emergency Braking (PEB) is not intended to avoid a collision on its own, nor can PEB detect every type of potential collision with a pedestrian. The driver has the responsibility to avoid a collision by controlling the vehicle via braking and steering. Failure to follow this warning could lead to serious injury or death.

TIRE PRESSURE MONITORING SYSTEM (TPMS)

The Tire Pressure Monitoring System (TPMS) will warn the driver of a low tire pressure based on the vehicle recommended cold placard pressure.

The tire pressure will vary with temperature by about 1 psi (7 kPa) for every 12°F (6.5°C). This means that when the outside temperature decreases, the tire pressure will decrease. Tire pressure should always be set based on cold inflation tire pressure. This is defined as the tire pressure after the vehicle has not been driven for at least three hours, or driven less than 1 mile (1.6 km) after a three hour period. The cold tire inflation pressure must not exceed the maximum inflation pressure molded into the tire sidewall. The tire pressure will also increase as the vehicle is driven — this is normal and there should be no adjustment for this increased pressure.

See ⇨ page 244 on how to properly inflate the vehicle's tires.

The TPMS will warn the driver of a low tire pressure if the tire pressure falls below the low-pressure warning limit for any reason, including low temperature effects and natural pressure loss through the tire.

The TPMS will continue to warn the driver of low tire pressure as long as the condition exists, and will not turn off until the tire pressure is at or above the recommended cold placard pressure. Once the low tire pressure warning (TPMS Warning Light) illuminates, you must increase the tire pressure to the recommended cold placard pressure in order for the TPMS Warning Light to turn off. The system will automatically update and the TPMS Warning Light will turn off once the sys-

tem receives the updated tire pressures. The vehicle may need to be driven for up to 20 minutes above 15 mph (24 km/h) in order for the TPMS to receive this information.

NOTE:

When filling warm tires, the tire pressure may need to be increased up to an additional 4 psi (28 kPa) above the recommended cold placard pressure in order to turn the TPMS Warning Light off.

For example, your vehicle may have a recommended cold (parked for more than three hours) placard pressure of 30 psi (207 kPa). If the ambient temperature is 68°F (20°C) and the measured tire pressure is 27 psi (186 kPa), a temperature drop to 20°F (-7°C) will decrease the tire pressure to approximately 23 psi (158 kPa). This tire pressure is sufficiently low enough to turn on the TPMS Warning Light. Driving the vehicle may cause the tire pressure to rise to approximately 27 psi (186 kPa), but the TPMS Warning Light will still be on. In this situation, the TPMS Warning Light will turn off only after the tires are inflated to the vehicle's recommended cold placard pressure value.

CAUTION!

- The TPMS has been optimized for the original equipment tires and wheels. TPMS pressures and warning have been established for the tire size equipped on your vehicle. Undesirable system operation or sensor damage may result when using replacement equipment that is not of the same size, type, and/or style. Aftermarket wheels can cause sensor damage.

(Continued)

CAUTION!

- Using aftermarket tire sealants may cause the Tire Pressure Monitoring System (TPMS) sensor to become inoperable. After using an aftermarket tire sealant it is recommended that you take your vehicle to an authorized dealership to have your sensor function checked.
- After inspecting or adjusting the tire pressure always reinstall the valve stem cap. This will prevent moisture and dirt from entering the valve stem, which could damage the TPMS sensor.

NOTE:

- The TPMS is not intended to replace normal tire care and maintenance or to provide warning of a tire failure or condition.
- The TPMS should not be used as a tire pressure gauge while adjusting your tire pressure.
- Driving on a significantly underinflated tire causes the tire to overheat and can lead to tire failure. Underinflation also reduces fuel efficiency and tire tread life, and may affect the vehicle's handling and stopping ability.
- The TPMS is not a substitute for proper tire maintenance, and it is the driver's responsibility to maintain correct tire pressure using an accurate tire pressure gauge, even if underinflation has not reached the level to trigger illumination of the TPMS Warning Light.
- Seasonal temperature changes will affect tire pressure, and the TPMS will monitor the actual tire pressure in the tire ⇨ page 269.

Base System



This is the TPMS Warning Light located in the instrument cluster.

The TPMS uses wireless technology with wheel rim mounted electronic sensors to monitor tire pressure levels. Sensors, mounted to each wheel as part of the valve stem, transmit tire pressure readings to the receiver module.

NOTE:

It is particularly important for you to check the tire pressure in all of the tires on your vehicle regularly and to maintain the proper pressure.

The TPMS consists of the following components:

- Receiver module
- Four Tire Pressure Monitoring System sensors
- Tire Pressure Monitoring System Warning Light

Tire Pressure Monitoring System Low Pressure Warnings

The Tire Pressure Monitoring System Warning Light will illuminate in the instrument cluster, an audible chime will be activated, and the “Check tire pressure” message will display when one or more of the four active road tire pressures are low. Should this occur, you should stop as soon as possible, check the inflation pressure of each tire on your vehicle, and inflate each tire to the vehicle’s recommended cold placard pressure value. The system will automatically update and the Tire Pressure Monitoring System Warning Light will

extinguish once the updated tire pressures have been received. The vehicle may need to be driven for up to 20 minutes above 15 mph (24 km/h) to receive this information.

Check TPMS Warnings

The Tire Pressure Monitoring System Warning Light will flash on and off for 75 seconds and remain on solid when a system fault is detected, an audible chime will be activated and the “Tire Pressure Monitoring Unavailable” message will display. If the ignition key is cycled, this sequence will repeat providing the system fault still exists. The TPMS Warning Light will turn off when the fault condition no longer exists. A system fault can occur with any of the following scenarios:

- Jamming due to electronic devices or driving next to facilities emitting the same radio frequencies as the TPMS sensors
- Installing some form of aftermarket window tinting that affects radio wave signals
- Snow or ice around the wheels or wheel housings
- Using tire chains on the vehicle
- Using wheels/tires not equipped with TPMS sensors

NOTE:

Your vehicle is equipped with a regular size spare wheel.

1. The spare tire does not have a TPMS sensor. Therefore, the TPMS will not monitor the pressure in the spare tire.
2. If a spare tire not equipped with the Tire Pressure Monitoring System sensor is used, the TPMS Warning Light will turn on, flashing for 75 seconds and then remaining solid for each subsequent ignition key cycle.

3. Once you repair or replace the original road tire and reinstall it on the vehicle in place of the spare tire, the TPMS will update automatically and the Tire Pressure Monitoring System Warning Light will extinguish once the updated tire pressures have been received. The vehicle may need to be driven for up to 20 minutes above 15 mph (24 km/h) to receive this information.

NOTE:

For correct Tire Pressure Monitoring System behavior, please wait for about 20 minutes in key-off during each tire substitution.

OCCUPANT RESTRAINT SYSTEMS

Some of the most important safety features in your vehicle are the restraint systems:

OCCUPANT RESTRAINT SYSTEMS FEATURES

- Seat Belt Systems
- Supplemental Restraint Systems (SRS) Air Bags
- Child Restraints

Some of the safety features described in this section may be standard equipment on some models, or may be optional or not equipped on others. If you are not sure, ask an authorized dealer.

IMPORTANT SAFETY PRECAUTIONS

Please pay close attention to the information in this section. It tells you how to use your restraint system properly, to keep you and your passengers (if your vehicle is equipped with passenger seating) as safe as possible.

Here are some simple steps you can take to minimize the risk of harm from a deploying air bag:

1. Children 12 years old and under should always ride buckled up in the rear seat of a vehicle with a rear seat.
2. A child who is not big enough to wear the vehicle seat belt properly must be secured in the appropriate child restraint or belt-positioning booster seat in a rear seating position ↪ page 177.
3. If a child from 2 to 12 years old (not in a rear-facing child restraint) must ride in the front passenger seat, move the seat as far back as possible and use the proper child restraint ↪ page 177.
4. Never allow children to slide the shoulder belt behind them or under their arm.
5. You should read the instructions provided with your child restraint to make sure that you are using it properly.
6. All occupants should always wear their lap and shoulder belts properly.
7. The driver and front passenger seats should be moved back as far as practical to allow the front air bags room to inflate.
8. Do not lean against the door or window. If your vehicle has side air bags, and deployment occurs, the side air bags will inflate forcefully into the space between occupants and the door and occupants could be injured.
9. If the air bag system in this vehicle needs to be modified to accommodate a disabled person, see ↪ page 266 for customer service contact information.

WARNING!

- Never place a rear-facing child restraint in front of an air bag. A deploying passenger front air bag can cause death or serious injury to a child 12 years or younger, including a child in a rear-facing child restraint.
- Never install a rear-facing child restraint in the front seat of a vehicle. Only use a rear-facing child restraint in the rear seat. If the vehicle does not have a rear seat, do not transport a rear-facing child restraint in that vehicle.

SEAT BELT SYSTEMS

Buckle up even though you are an excellent driver, even on short trips. Someone on the road may be a poor driver and could cause a collision that includes you. This can happen far away from home or on your own street.

Research has shown that seat belts save lives, and they can reduce the seriousness of injuries in a collision. Some of the worst injuries happen when people are thrown from the vehicle. Seat belts reduce the possibility of ejection and the risk of injury caused by striking the inside of the vehicle. Everyone in a motor vehicle should be belted at all times.

Enhanced Seat Belt Use Reminder System (BeltAlert)

Driver And Passenger BeltAlert — If Equipped



BeltAlert is a feature intended to remind the driver and outboard front seat passenger (if equipped with outboard front passenger

seat BeltAlert) to buckle their seat belts. The BeltAlert feature is active whenever the ignition switch is in the AVV (START) or MAR (ACC/ON/RUN) position.

Initial Indication

If the driver is unbuckled when the ignition switch is first in the AVV (START) or MAR (ACC/ON/RUN) position, a chime will signal for a few seconds. If the driver or outboard front seat passenger (if equipped with outboard front passenger seat BeltAlert) is unbuckled when the ignition switch is first in the AVV (START) or MAR (ACC/ON/RUN) position the Seat Belt Reminder Light will turn on and remain on until both outboard front seat belts are buckled. The outboard front passenger seat BeltAlert is not active when an outboard front passenger seat is unoccupied.

BeltAlert Warning Sequence

The BeltAlert warning sequence is activated when the vehicle is moving above a specified vehicle speed range and the driver or outboard front seat passenger is unbuckled (if equipped with outboard front passenger seat BeltAlert) (the outboard front passenger seat BeltAlert is not active when the outboard front passenger seat is unoccupied). The BeltAlert warning sequence starts by blinking the Seat Belt Reminder Light and sounding an intermittent chime. Once the BeltAlert warning sequence has completed, the Seat Belt Reminder Light will remain on until the seat belts are buckled. The BeltAlert warning sequence may repeat based on vehicle speed until the driver and occupied outboard front seat passenger seat belts are buckled. The driver should instruct all occupants to buckle their seat belts.

Change Of Status

If the driver or outboard front seat passenger (if equipped with outboard front passenger seat BeltAlert) unbuckles their seat belt while the vehicle is traveling, the BeltAlert warning sequence will begin until the seat belts are buckled again.

The outboard front passenger seat BeltAlert is not active when the outboard front passenger seat is unoccupied. BeltAlert may be triggered when an animal or other items are placed on the outboard front passenger seat or when the seat is folded flat (if equipped). It is recommended that pets be restrained in the rear seat (if equipped) in pet harnesses or pet carriers that are secured by seat belts, and cargo is properly stowed.

BeltAlert can be activated or deactivated by an authorized dealer. FCA US LLC does not recommend deactivating BeltAlert.

NOTE:

If BeltAlert has been deactivated and the driver or outboard front seat passenger (if equipped with outboard front passenger seat BeltAlert) is unbuckled the Seat Belt Reminder Light will turn on and remain on until the driver and outboard front seat passenger seat belts are buckled.

Lap/Shoulder Belts

All seating positions in your vehicle are equipped with lap/shoulder belts.

The seat belt webbing retractor will lock only during very sudden stops or collisions. This feature allows the shoulder part of the seat belt to move freely with you under normal conditions. However, in a collision the seat belt will lock and reduce your risk of striking the inside of the vehicle or being thrown out of the vehicle.

WARNING!

- Relying on the air bags alone could lead to more severe injuries in a collision. The air bags work with your seat belt to restrain you properly. In some collisions, the air bags won't deploy at all. Always wear your seat belt even though you have air bags.
- In a collision, you and your passengers can suffer much greater injuries if you are not properly buckled up. You can strike the interior of your vehicle or other passengers, or you can be thrown out of the vehicle. Always be sure you and others in your vehicle are buckled up properly.
- It is dangerous to ride in a cargo area, inside or outside of a vehicle. In a collision, people riding in these areas are more likely to be seriously injured or killed.
- Do not allow people to ride in any area of your vehicle that is not equipped with seats and seat belts.
- Be sure everyone in your vehicle is in a seat and using a seat belt properly. Occupants, including the driver, should always wear their seat belts whether or not an air bag is also provided at their seating position to minimize the risk of severe injury or death in the event of a crash.
- Wearing your seat belt incorrectly could make your injuries in a collision much worse. You might suffer internal injuries, or you could even slide out of the seat belt. Follow these instructions to wear your seat belt safely and to keep your passengers safe, too.
- Two people should never be belted into a single seat belt. People belted together can crash into one another in a collision, hurting one another

(Continued)

WARNING!

badly. Never use a lap/shoulder belt or a lap belt for more than one person, no matter what their size.

WARNING!

- A lap belt worn too high can increase the risk of injury in a collision. The seat belt forces won't be at the strong hip and pelvic bones, but across your abdomen. Always wear the lap part of your seat belt as low as possible and keep it snug.
- A twisted seat belt may not protect you properly. In a collision, it could even cut into you. Be sure the seat belt is flat against your body, without twists. If you can't straighten a seat belt in your vehicle, take it to an authorized dealer immediately and have it fixed.
- A seat belt that is buckled into the wrong buckle will not protect you properly. The lap portion could ride too high on your body, possibly causing internal injuries. Always buckle your seat belt into the buckle nearest you.
- A seat belt that is too loose will not protect you properly. In a sudden stop, you could move too far forward, increasing the possibility of injury. Wear your seat belt snugly.
- A seat belt that is worn under your arm is dangerous. Your body could strike the inside surfaces of the vehicle in a collision, increasing head and neck injury. A seat belt worn under the arm can cause

(Continued)

WARNING!

internal injuries. Ribs aren't as strong as shoulder bones. Wear the seat belt over your shoulder so that your strongest bones will take the force in a collision.

- A shoulder belt placed behind you will not protect you from injury during a collision. You are more likely to hit your head in a collision if you do not wear your shoulder belt. The lap and shoulder belt are meant to be used together.
- A frayed or torn seat belt could rip apart in a collision and leave you with no protection. Inspect the seat belt system periodically, checking for cuts, frays, or loose parts. Damaged parts must be replaced immediately. Do not disassemble or modify the seat belt system. If your vehicle is involved in a collision, or if you have questions regarding seat belt or retractor conditions, take your vehicle to an authorized FCA dealer or authorized FCA Certified Collision Care Program facility for inspection.

Lap/Shoulder Belt Operating Instructions

1. Enter the vehicle and close the door. Sit back and adjust the seat.
2. The seat belt latch plate is above the back of the front seat, and next to your arm in the rear seat (for vehicles equipped with a rear seat). Grab the latch plate and pull out the seat belt. Slide the latch plate up the webbing as far as necessary to allow the seat belt to go around your lap.



Pulling Out The Latch Plate



Inserting Latch Plate Into Buckle

3. When the seat belt is long enough to fit, insert the latch plate into the buckle until you hear a "click."
4. Position the lap belt so that it is snug and lies low across your hips, below your abdomen. To remove slack in the lap belt portion, pull up on the shoulder belt. To loosen the lap belt if it is too tight, tilt the latch plate and pull on the lap belt. A snug seat belt reduces the risk of sliding under the seat belt in a collision.



Positioning The Lap Belt

5. Position the shoulder belt across the shoulder and chest with minimal, if any slack so that it is comfortable and not resting on your neck. The retractor will withdraw any slack in the shoulder belt.
6. To release the seat belt, push the red button on the buckle. The seat belt will automatically retract to its stowed position. If necessary, slide the latch plate down the webbing to allow the seat belt to retract fully.

Lap/Shoulder Belt Untwisting Procedure

Use the following procedure to untwist a twisted lap/shoulder belt.

1. Position the latch plate as close as possible to the anchor point.
2. At about 6 to 12 inches (15 to 30 cm) above the latch plate, grab and twist the seat belt webbing 180 degrees to create a fold that begins immediately above the latch plate.

- Slide the latch plate upward over the folded webbing. The folded webbing must enter the slot at the top of the latch plate.
- Continue to slide the latch plate up until it clears the folded webbing and the seat belt is no longer twisted.

Adjustable Upper Shoulder Belt Anchorage - If Equipped

In the driver and outboard front passenger seats, the top of the shoulder belt can be adjusted upward or downward to position the seat belt away from your neck. Push or squeeze the anchorage button to release the anchorage, and move it up or down to the position that serves you best.

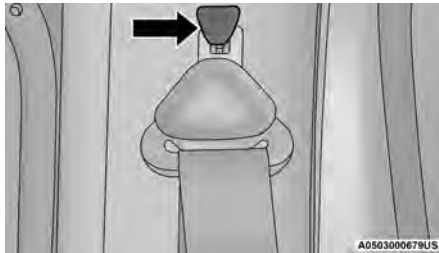

Adjustable Anchorage

As a guide, if you are shorter than average, you will prefer the shoulder belt anchorage in a lower position, and if you are taller than average, you will prefer the shoulder belt anchorage in a higher position. After you release the anchorage button, try to move it up or down to make sure that it is locked in position.

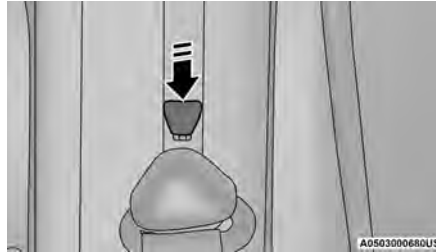

Adjustable Anchorage

NOTE:

The adjustable upper shoulder belt anchorage is equipped with an Easy Up feature. This feature allows the shoulder belt anchorage to be adjusted in the upward position without pushing or squeezing the release button. To verify the shoulder belt anchorage is latched, pull downward on the shoulder belt anchorage until it is locked into position.

WARNING!

- Wearing your seat belt incorrectly could make your injuries in a collision much worse. You might suffer internal injuries, or you could even slide out of the seat belt. Follow these instructions to wear your seat belt safely and to keep your passengers safe, too.
- Position the shoulder belt across the shoulder and chest with minimal, if any slack so that it is comfortable and not resting on your neck. The retractor will withdraw any slack in the shoulder belt.

(Continued)

WARNING!

- Misadjustment of the seat belt could reduce the effectiveness of the safety belt in a crash.
- Always make all seat belt height adjustments when the vehicle is stationary.

Seat Belts And Pregnant Women



Seat Belts And Pregnant Women

Seat belts must be worn by all occupants including pregnant women: the risk of injury in the event of an accident is reduced for the mother and the unborn child if they are wearing a seat belt.

Position the lap belt snug and low below the abdomen and across the strong bones of the hips. Place the shoulder belt across the chest and away from the neck. Never place the shoulder belt behind the back or under the arm.

Seat Belt Pretensioner — If Equipped

The front seat belt system is equipped with pretensioning devices that are designed to remove slack from the seat belt in the event of a collision. These devices may improve the performance of the seat belt by removing slack from the seat belt early in a collision. Pretensioners work for all size occupants, including those in child restraints.

NOTE:

These devices are not a substitute for proper seat belt placement by the occupant. The seat belt still must be worn snugly and positioned properly.

The pretensioners are triggered by the Occupant Restraint Controller (ORC). Like the air bags, the pretensioners are single use items. A deployed pretensioner or a deployed air bag must be replaced immediately.

Energy Management Feature

The front seat belt system is equipped with an Energy Management feature that may help further reduce the risk of injury in the event of a collision. The seat belt system has a retractor assembly that is designed to release webbing in a controlled manner.

Switchable Automatic Locking Retractor (ALR) — If Equipped

The seat belt in the passenger seating position is equipped with a Switchable Automatic Locking Retractor (ALR) which is used to secure a child restraint system → page 179. The figure below illustrates the locking feature for each seating position.

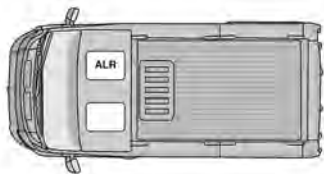

A0503000681US

Front Bucket Seat: Switchable Automatic Locking Retractor (ALR) Location

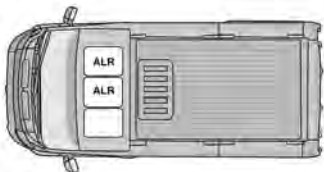

A0503000682US

Front Bench Seat: Switchable Automatic Locking Retractor (ALR) Locations

NOTE:

The BEV model is not equipped with a passenger seat. If the passenger seating position is equipped with an ALR and is being used for normal usage, only pull the seat belt webbing out far enough to comfortably wrap around the occupant's mid-section so as to not activate the ALR. If the ALR is activated, you will hear a clicking sound as the seat belt retracts. Allow the webbing to retract completely in this case and then carefully pull out only the amount of webbing necessary to comfortably wrap around the occupant's mid-section. Slide the latch plate into the buckle until you hear a "click."

In Automatic Locking Mode, the shoulder belt is automatically pre-locked. The seat belt will still retract to remove any slack in the shoulder belt. Use the Automatic Locking Mode anytime a child restraint is installed in a seating position that has a seat belt with this feature. Children 12 years old and under should always be properly restrained in the rear seat of a vehicle with a rear seat.

WARNING!

- Never place a rear-facing child restraint in front of an air bag. A deploying passenger front air bag can cause death or serious injury to a child 12 years or younger, including a child in a rear-facing child restraint.
- Never install a rear-facing child restraint in the front seat of a vehicle. Only use a rear-facing child restraint in the rear seat. If the vehicle does not have a rear seat, do not transport a rear-facing child restraint in that vehicle.

How To Engage The Automatic Locking Mode

1. Buckle the combination lap and shoulder belt.
2. Grab the shoulder portion and pull downward until the entire seat belt is extracted.
3. Allow the seat belt to retract. As the seat belt retracts, you will hear a clicking sound. This indicates the seat belt is now in the Automatic Locking Mode.

How To Disengage The Automatic Locking Mode

Unbuckle the combination lap/shoulder belt and allow it to retract completely to disengage the Automatic Locking Mode and activate the vehicle sensitive (emergency) locking mode.

WARNING!

- The seat belt assembly must be replaced if the switchable Automatic Locking Retractor (ALR) feature or any other seat belt function is not working properly when checked according to the procedures in the Service Manual.
- Failure to replace the seat belt assembly could increase the risk of injury in collisions.
- Do not use the Automatic Locking Mode to restrain occupants who are wearing the seat belt or children who are using booster seats. The locked mode is only used to install rear-facing or forward-facing child restraints that have a harness for restraining the child.

SUPPLEMENTAL RESTRAINT SYSTEMS (SRS)

Some of the safety features described in this section may be standard equipment on some models, or may be optional or not equipped on others. If you are not sure, ask an authorized dealer.

The air bag system must be ready to protect you in a collision. The Occupant Restraint Controller (ORC) monitors the internal circuits and interconnecting wiring associated with the electrical Air Bag System Components. Your vehicle may be equipped with the following Air Bag System Components:

Air Bag System Components

- Occupant Restraint Controller (ORC)
- Air Bag Warning Light 
- Steering Wheel and Column
- Instrument Panel
- Driver and Front Passenger Air Bags (If Equipped)
- Seat Belt Buckle Switch
- Supplemental Side Air Bags
- Front and Side Impact Sensors
- Seat Belt Pretensioners

Air Bag Warning Light



The Occupant Restraint Controller (ORC) monitors the readiness of the electronic parts of the air bag system whenever the ignition switch is in the START or ON/RUN position. If the ignition switch is in the OFF position or in the ACC position, the air bag system is not on and the air bags will not inflate.

The ORC contains a backup power supply system that may deploy the air bag system even if the battery loses power or it becomes disconnected prior to deployment.

The ORC turns on the Air Bag Warning Light in the instrument panel for approximately four to eight seconds for a self-check when the ignition switch is first in the ON/RUN position. After the self-check, the Air Bag Warning Light will turn off. If the ORC detects a malfunction in any part of the system, it turns on the Air Bag Warning Light, either momentarily or continuously. A single chime will sound to alert you if the light comes on again after initial startup.

The ORC also includes diagnostics that will illuminate the instrument panel Air Bag Warning Light if a malfunction is detected that could affect the air bag system. The diagnostics also record the nature of the malfunction. While the air bag system is designed to be maintenance free, if any of the following occurs, have an authorized dealer service the air bag system immediately.

- The Air Bag Warning Light does not come on during the four to eight seconds when the ignition switch is first in the ON/RUN position.
- The Air Bag Warning Light remains on after the four to eight-second interval.
- The Air Bag Warning Light comes on intermittently or remains on while driving.

NOTE:

If the speedometer, tachometer, or any engine related gauges are not working, the Occupant Restraint Controller (ORC) may also be disabled. In this condition the air bags may not be ready to inflate for your protection. Have an authorized dealer service the air bag system immediately.

WARNING!

Ignoring the Air Bag Warning Light in your instrument panel could mean you won't have the air bag system to protect you in a collision. If the light does not come on as a bulb check when the ignition is first turned on, stays on after you start the vehicle, or if it comes on as you drive, have an authorized dealer service the air bag system immediately.

Front Air Bags

This vehicle has front air bags and lap/shoulder belts for both the driver and front passenger. The front air bags are a supplement to the seat belt restraint systems. The driver front air bag is mounted in the center of the steering wheel. The passenger front air bag (if equipped) is mounted in the instrument panel, above the glove compartment. The words "SRS AIRBAG" or "AIRBAG" are embossed on the air bag covers.

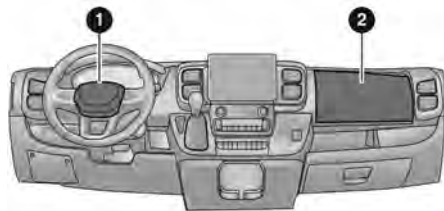

A185030091248US

Front Air Bag Locations

- 1 — Driver Front Air Bag
2 — Passenger Front Air Bag (If Equipped)

WARNING!

- Being too close to the steering wheel or instrument panel during front air bag deployment could cause serious injury, including death. Air bags need room to inflate. Sit back, comfortably extending your arms to reach the steering wheel or instrument panel.
- Never place a rear-facing child restraint in front of an air bag. A deploying passenger front air bag can cause death or serious injury to a child 12 years or younger, including a child in a rear-facing child restraint.
- Never install a rear-facing child restraint in the front seat of a vehicle. Only use a rear-facing child restraint in the rear seat. If the vehicle does not have a rear seat, do not transport a rear-facing child restraint in that vehicle.

Driver And Passenger Front Air Bag Features

The driver and passenger front air bag system is designed to inflate based on the severity and type of collision as determined by the Occupant Restraint Controller (ORC), which may receive information from the front impact sensors (if equipped) or other system components.

WARNING!

- No objects should be placed over or near the air bag on the instrument panel or steering wheel because any such objects could cause harm if the vehicle is in a collision severe enough to cause the air bag to inflate.

*(Continued)***WARNING!**

- Do not put anything on or around the air bag covers or attempt to open them manually. You may damage the air bags and you could be injured because the air bags may no longer be functional. The protective covers for the air bag cushions are designed to open only when the air bags are inflating.
- Relying on the air bags alone could lead to more severe injuries in a collision. The air bags work with your seat belt to restrain you properly. In some collisions, air bags won't deploy at all. Always wear your seat belts even though you have air bags.

Front Air Bag Operation

Front Air Bags are designed to provide additional protection by supplementing the seat belts. Front air bags are not expected to reduce the risk of injury in rear, side, or rollover collisions. The front air bags will not deploy in all frontal collisions, including some that may produce substantial vehicle damage — for example, some pole collisions, truck underrides, and angle offset collisions.

On the other hand, depending on the type and location of impact, front air bags may deploy in crashes with little vehicle front-end damage but that produce a severe initial deceleration.

Because air bag sensors measure vehicle deceleration over time, vehicle speed and damage by themselves are not good indicators of whether or not an air bag should have deployed.

Seat belts are necessary for your protection in all collisions, and also are needed to help keep you in position, away from an inflating air bag.

When the Occupant Restraint Controller (ORC) detects a collision requiring the front air bags, it signals the inflator units. A large quantity of non-toxic gas is generated to inflate the front air bags.

The steering wheel hub trim cover and the upper passenger side of the instrument panel separate and fold out of the way as the air bags inflate to their full size. The front air bags fully inflate in less time than it takes to blink your eyes. The front air bags then quickly deflate while helping to restrain the driver and front passenger.

Supplemental Side Air Bags

Supplemental Seat-Mounted Side Air Bags (SABs)

This vehicle is equipped with Supplemental Seat-Mounted Side Air Bags (SABs).

Supplemental Seat-Mounted Side Air Bags (SABs) are located in the outboard side of the front seats. The SABs are marked with "SRS AIRBAG" or "AIRBAG" on a label or on the seat trim on the outboard side of the seats.

The SABs may help to reduce the risk of occupant injury during certain side impacts, in addition to the injury reduction potential provided by the seat belts and body structure (where that side of the vehicle has an outboard seat equipped).

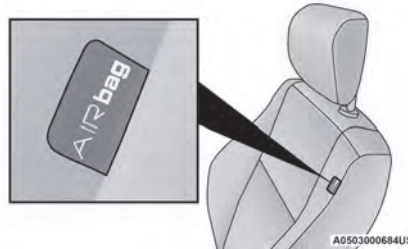

Front Supplemental Seat-Mounted Side Air Bag Label

When the SAB deploys, it opens the seam on the outboard side of the seatback's trim cover. The inflating SAB deploys through the seat seam into the space between the occupant and the door. The SAB moves at a very high speed and with such a high force that it could injure occupants if they are not seated properly, or if items are positioned in the area where the SAB inflates. Children are at an even greater risk of injury from a deploying air bag.

WARNING!

Do not use accessory seat covers or place objects between you and the Side Air Bags; the performance could be adversely affected and/or objects could be pushed into you, causing serious injury.

Supplemental Side Air Bag Inflatable Curtains (SABICs)

This vehicle is equipped with Supplemental Side Air Bag Inflatable Curtains (SABICs).

Supplemental Side Air Bag Inflatable Curtains (SABICs) are located above the side windows. The trim covering the SABICs is labeled "SRS AIRBAG" or "AIRBAG."



Supplemental Side Air Bag Inflatable Curtain (SABIC) Label Location

SABICs may help reduce the risk of head and other injuries to front and rear seat outboard occupants in certain side impacts, in addition to the injury reduction potential provided by the seat belts and body structure.

The SABIC deploys downward, covering the side windows. An inflating SABIC pushes the outside edge of the headliner out of the way and covers the window. The SABICs inflate with enough force to injure occupants if they are not belted and seated properly, or if items are positioned in the area where the SABICs inflate. Children are at an even greater risk of injury from a deploying air bag.

The SABICs may help reduce the risk of partial or complete ejection of vehicle occupants through side windows in certain side impact events.

WARNING!

- Do not mount equipment, or stack luggage or other cargo up high enough to block the deployment of the SABICs. The trim covering above the side windows where the SABIC and its deployment path are located should remain free from any obstructions.
- In order for the SABICs to work as intended, do not install any accessory items in your vehicle which could alter the roof. Do not add an aftermarket sunroof to your vehicle. Do not add roof racks that require permanent attachments (bolts or screws) for installation on the vehicle roof. Do not drill into the roof of the vehicle for any reason.

Side Impacts

The Side Air Bags are designed to activate in certain side impacts. The Occupant Restraint Controller (ORC) determines whether the deployment of the Side Air Bags in a particular impact event is appropriate, based on the severity and type of collision. The side impact sensors aid the ORC in determining the appropriate response to impact events. The system is calibrated to deploy the Side Air Bags on the impact side of the vehicle during impacts that require Side Air Bag occupant protection. In side impacts, the Side Air Bags deploy independently; a left side impact deploys the left Side Air Bags only and a right-side impact deploys the right Side Air Bags only. Vehicle damage by itself is not a good indicator of whether or not Side Air Bags should have deployed.

The Side Air Bags will not deploy in all side collisions, including some collisions at certain angles, or some side collisions that do not impact the area of the passenger compartment. The Side Air Bags may deploy during angled or offset frontal collisions where the front air bags deploy.

Side Air Bags are a supplement to the seat belt restraint system. Side Air Bags deploy in less time than it takes to blink your eyes.

WARNING!

- Occupants, including children, who are up against or very close to Side Air Bags can be seriously injured or killed. Occupants, including children, should never lean on or sleep against the door, side windows, or area where the side air bags inflate, even if they are in an infant or child restraint.
- Seat belts (and child restraints where appropriate) are necessary for your protection in all collisions. They also help keep you in position, away from an inflating Side Air Bag. To get the best protection from the Side Air Bags, occupants must wear their seat belts properly and sit upright with their backs against the seats. Children must be properly restrained in a child restraint or booster seat that is appropriate for the size of the child.

WARNING!

- Side Air Bags need room to inflate. Do not lean against the door or window. Sit upright in the center of the seat.

(Continued)

WARNING!

- Being too close to the Side Air Bags during deployment could cause you to be severely injured or killed.
- Relying on the Side Air Bags alone could lead to more severe injuries in a collision. The Side Air Bags work with your seat belt to restrain you properly. In some collisions, Side Air Bags won't deploy at all. Always wear your seat belt even though you have Side Air Bags.

NOTE:

Air bag covers may not be obvious in the interior trim, but they will open during air bag deployment.

Rollover Events

Side Air Bags and seat belt pretensioners are designed to activate in certain rollover events. The Occupant Restraint Controller (ORC) determines whether deployment in a particular rollover event is appropriate, based on the severity and type of collision. Vehicle damage by itself is not a good indicator of whether or not Side Air Bags and seat belt pretensioners should have deployed.

The Side Air Bags and seat belt pretensioners will not deploy in all rollover events. The rollover sensing system determines if a rollover event may be in progress and whether deployment is appropriate. In the event the vehicle experiences a rollover or near rollover event, and deployment is appropriate, the rollover sensing system will deploy the side air bags and seat belt pretensioners on both sides of the vehicle.

The SABICs may help reduce the risk of partial or complete ejection of vehicle occupants through side windows in certain rollover or side impact events.

Air Bag System Components

NOTE:

The Occupant Restraint Controller (ORC) monitors the internal circuits and interconnecting wiring associated with electrical Air Bag System Components listed below:

- Occupant Restraint Controller (ORC)
- Air Bag Warning Light 
- Steering Wheel and Column
- Instrument Panel
- Driver and Front Passenger Air Bags (If Equipped)
- Seat Belt Buckle Switch
- Supplemental Side Air Bags
- Front and Side Impact Sensors
- Seat Belt Pretensioners

If A Deployment Occurs

The front air bags are designed to deflate immediately after deployment.

NOTE:

Front and/or side air bags will not deploy in all collisions. This does not mean something is wrong with the air bag system.

If you do have a collision which deploys the air bags, any or all of the following may occur:

- The air bag material may sometimes cause abrasions and/or skin reddening to the occupants as the air bags deploy and unfold. The abrasions are similar to friction rope burns or those you might get sliding along a carpet or gymnasium floor. They are not caused by contact with chemicals. They are not per-

manent and normally heal quickly. However, if you haven't healed significantly within a few days, or if you have any blistering, see your doctor immediately.

- As the air bags deflate, you may see some smoke-like particles. The particles are a normal by-product of the process that generates the non-toxic gas used for air bag inflation. These airborne particles may irritate the skin, eyes, nose, or throat. If you have skin or eye irritation, rinse the area with cool water. For nose or throat irritation, move to fresh air. If the irritation continues, see your doctor. If these particles settle on your clothing, follow the garment manufacturer's instructions for cleaning.

Do not drive your vehicle after the air bags have deployed. If you are involved in another collision, the air bags will not be in place to protect you.

WARNING!

Deployed air bags and seat belt pretensioners cannot protect you in another collision. Have the air bags, seat belt pretensioners, and the seat belt retractor assemblies replaced by an authorized dealer immediately. Also, have the Occupant Restraint Controller System serviced as well.

NOTE:

- Air bag covers may not be obvious in the interior trim, but they will open during air bag deployment.
- After any collision, the vehicle should be taken to an authorized dealer immediately.

Enhanced Accident Response System

In the event of an impact, if the communication network remains intact, and the power remains intact, depending on the nature of the event, the Occupant Restraint Controller (ORC) will determine whether to have the Enhanced Accident Response System perform the following functions:

- Cut off fuel to the engine (if equipped)
- Cut off battery power to the electric motor (if equipped)
- Flash hazard lights as long as the battery has power
- Turn on the interior lights, which remain on as long as the battery has power or for 15 minutes from the intervention of the Enhanced Accident Response System
- Unlock the power door locks

Your vehicle may also be designed to perform any of these other functions in response to the Enhanced Accident Response System:

- Turn off the Fuel Filter Heater, Turn off the HVAC Blower Motor, Close the HVAC Circulation Door
- Cut off battery power to the:
 - Engine (if equipped)
 - Electric Motor (if equipped)
 - Electric power steering
 - Brake booster
 - Electric park brake
 - Automatic transmission gear selector
 - Horn
 - Front wiper

NOTE:

For gas vehicles, after an accident, remember to place the ignition in the STOP (OFF) position to avoid draining the battery. Carefully check the vehicle for fuel leaks in the engine compartment and on the ground near the engine compartment and fuel tank before resetting the system and starting the engine. If there are no fuel leaks or damage to the vehicle electrical devices (e.g. headlights) after an accident, reset the system by following the procedure described below. If you have any doubt, contact an authorized dealer.

NOTE:

For BEV vehicles, after an accident, remember to place the ignition in the STOP (OFF) position to avoid draining the battery. Carefully check the vehicle before resetting the system. If there is no damage to the vehicles' electrical devices (e.g. headlights) after an accident, reset the system by following the procedure described below. If you have any doubt, contact an authorized dealer.

Enhanced Accident Response System Reset Procedure

After the event occurs, when the system is active, a message regarding the fuel cutoff is displayed. Turn the ignition switch from ignition ON to ignition OFF. Carefully check the vehicle for fuel leaks in the engine compartment and on the ground near the engine compartment and fuel tank before resetting the system and starting the engine.

Depending on the nature and severity of the event, the reset procedure can be performed by turning the ignition switch from ignition OFF to ignition ON. If the vehicle will not start after performing the reset procedure, the vehicle must be towed to an authorized dealer to be inspected and to have the Enhanced Accident Response System reset.

BEV (If Equipped)

After an event occurs requiring activation of the Enhanced Accident Response System, when the system is active, a "Service Electrical System" message will be displayed on the instrument cluster. The vehicle is not drivable in this state and must be towed to an authorized dealer immediately to be inspected and have the Enhanced Accident Response System reset.

Maintaining Your Air Bag System

WARNING!

- Modifications to any part of the air bag system could cause it to fail when you need it. You could be injured if the air bag system is not there to protect you. Do not modify the components or wiring, including adding any kind of badges or stickers to the steering wheel hub trim cover or the upper passenger side of the instrument panel. Do not modify the front fascia/bumper, vehicle body structure, or add aftermarket side steps or running boards.
- It is dangerous to try to repair any part of the air bag system yourself. Be sure to tell anyone who works on your vehicle that it has an air bag system.
- Do not attempt to modify any part of your air bag system. The air bag may inflate accidentally or may not function properly if modifications are made. Take your vehicle to an authorized dealer for any air bag system service. If your seat, including your trim cover and cushion, needs to be serviced in any way (including removal or loosening/tightening of seat attachment bolts), take the vehicle to an authorized dealer. Only manufacturer approved

(Continued)

WARNING!

seat accessories may be used. If it is necessary to modify the air bag system for persons with disabilities, contact an authorized dealer.

Event Data Recorder (EDR)

This vehicle is equipped with an event data recorder (EDR). The main purpose of an EDR is to record, in certain crash or near crash-like situations, such as an air bag deployment or hitting a road obstacle, data that will assist in understanding how a vehicle's systems performed. The EDR is designed to record data related to vehicle dynamics and safety systems for a short period of time, typically 30 seconds or less. The EDR in this vehicle is designed to record such data as:

- How various systems in your vehicle were operating;
- Whether or not the driver and passenger safety belts were buckled/fastened;
- How far (if at all) the driver was depressing the accelerator and/or brake pedal; and,
- How fast the vehicle was traveling.

These data can help provide a better understanding of the circumstances in which crashes and injuries occur.

NOTE:

EDR data are recorded by your vehicle only if a non-trivial crash situation occurs; no data are recorded by the EDR under normal driving conditions and no personal data (e.g., name, gender, age, and crash location) are recorded. However, other parties, such as law enforcement, could combine the EDR data with the type of personally identifying data routinely acquired during a crash investigation.

To read data recorded by an EDR, special equipment is required, and access to the vehicle or the EDR is needed. In addition to the vehicle manufacturer, other parties, such as law enforcement, that have the special equipment, can read the information if they have access to the vehicle or the EDR.

CHILD RESTRAINTS

Everyone in your vehicle needs to be buckled up at all times, including babies and children. Every state in the United States, and every Canadian province, requires that small children ride in proper restraint systems. This is the law, and you can be prosecuted for ignoring it. Children 12 years or younger should ride properly buckled up in a rear seat, if available. According to crash statistics, children are safer when properly restrained in the rear seats rather than in the front.

BEV Models

This commercial vehicle is not designed for use as a family vehicle and is not intended for carrying children. Never install front-facing child restraints in this vehicle.

WARNING!

In a collision, an unrestrained child can become a projectile inside the vehicle. The force required to hold even an infant on your lap could become so great that you could not hold the child, no matter how strong you are. The child and others could be badly injured or killed. Any child riding in your vehicle should be in a proper restraint for the child's size.

There are different sizes and types of restraints for children from newborn size to the child almost large enough for an adult safety belt. Always check the child seat Owner's Manual to make sure you have the correct

seat for your child. Carefully read and follow all the instructions and warnings in the child restraint Owner's Manual and on all the labels attached to the child restraint.

Before buying any restraint system, make sure that it has a label certifying that it meets all applicable Safety Standards. You should also make sure that you can install it in the vehicle where you will use it.

NOTE:

- For additional information, refer to <http://www.nhtsa.gov/parents-and-caregivers> or call: 1-888-327-4236
- Canadian residents should refer to Transport Canada's website for additional information: <http://www.tc.gc.ca/en/services/road/child-car-seat-safety.html>

Summary Of Recommendations For Restraining Children In Vehicles

	Child Size, Height, Weight Or Age	Recommended Type Of Child Restraint
Infants and Toddlers	Children who are two years old or younger and who have not reached the height or weight limits of their child restraint	Either an Infant Carrier or a Convertible Child Restraint, facing rearward in a rear seat of the vehicle
Small Children	Children who are at least two years old or who have outgrown the height or weight limit of their rear-facing child restraint	Forward-Facing Child Restraint with a five-point Harness, facing forward in a rear seat of the vehicle
Larger Children	Children who have outgrown their forward-facing child restraint, but are too small to properly fit the vehicle's seat belt	Belt Positioning Booster Seat and the vehicle seat belt, seated in a rear seat of the vehicle
Children Too Large for Child Restraints	Children 12 years old or younger, who have outgrown the height or weight limit of their booster seat	Vehicle Seat Belt, seated in a rear seat of the vehicle

Infant And Child Restraints

NOTE:

This vehicle's optional rear bench seat allows rear-facing child restraints only. Do not place forward-facing child restraints in the rear seats because these restraints require upper tether attachments. This vehicle is not equipped with upper tethers.

Safety experts recommend that children ride rear-facing in the vehicle until they are two years old or until they reach either the height or weight limit of their rear-facing child restraint. Two types of child restraints can be used rear-facing: infant carriers and convertible child seats.

The infant carrier is only used rear-facing in the vehicle. It is recommended for children from birth until they reach the weight or height limit of the infant carrier. Convertible child seats can be used either rear-facing or forward-facing in the vehicle. Convertible child seats often have a higher weight limit in the rear-facing direction than infant carriers do, so they can be used rear-facing by children who have outgrown their infant carrier but are still less than at least two years old. Children should remain rear-facing until they reach the highest weight or height allowed by their convertible child seat.

WARNING!

- Never place a rear-facing child restraint in front of an air bag. A deploying passenger front air bag can cause death or serious injury to a child 12 years or younger, including a child in a rear-facing child restraint.

(Continued)

WARNING!

- Never install a rear-facing child restraint in the front seat of a vehicle. Only use a rear-facing child restraint in the rear seat. If the vehicle does not have a rear seat, do not transport a rear-facing child restraint in that vehicle.

Older Children And Child Restraints

Children who are two years old or who have outgrown their rear-facing convertible child seat can ride forward-facing in the vehicle. Forward-facing child seats and convertible child seats used in the forward-facing direction are for children who are over two years old or who have outgrown the rear-facing weight or height limit of their rear-facing convertible child seat. Children should remain in a forward-facing child seat with a harness for as long as possible, up to the highest weight or height allowed by the child seat.

All children whose weight or height is above the forward-facing limit for the child seat should use a belt-positioning booster seat until the vehicle's seat belts fit properly. If the child cannot sit with knees bent over the vehicle's seat cushion while the child's back is against the seatback, they should use a belt-positioning booster seat. The child and belt-positioning booster seat are held in the vehicle by the seat belt.

WARNING!

- Improper installation can lead to failure of an infant or child restraint. It could come loose in a collision. The child could be badly injured or killed. Follow the child restraint manufacturer's directions exactly when installing an infant or child restraint.

(Continued)

WARNING!

- After a child restraint is installed in the vehicle, do not move the vehicle seat forward or rearward because it can loosen the child restraint attachments. Remove the child restraint before adjusting the vehicle seat position. When the vehicle seat has been adjusted, reinstall the child restraint.
- When your child restraint is not in use, secure it in the vehicle with the seat belt or LATCH anchorages, or remove it from the vehicle. Do not leave it loose in the vehicle. In a sudden stop or accident, it could strike the occupants or seatbacks and cause serious personal injury.

Children Too Large For Booster Seats

Children who are large enough to wear the shoulder belt comfortably, and whose legs are long enough to bend over the front of the seat when their back is against the seatback, should use the seat belt in a rear seat. Use this simple 5-step test to decide whether the child can use the vehicle's seat belt alone:

1. Can the child sit all the way back against the back of the vehicle seat?
2. Do the child's knees bend comfortably over the front of the vehicle seat while the child is still sitting all the way back?
3. Does the shoulder belt cross the child's shoulder between the neck and arm?
4. Is the lap part of the belt as low as possible, touching the child's thighs and not the stomach?
5. Can the child stay seated like this for the whole trip?

If the answer to any of these questions was “no,” then the child still needs to use a booster seat in this vehicle. If the child is using the lap/shoulder belt, check seat belt fit periodically and make sure the seat belt buckle is latched. A child’s squirming or slouching can move the belt out of position. If the shoulder belt contacts the face or neck, move the child closer to the center of the vehicle, or use a booster seat to position the seat belt on the child correctly.

WARNING!

Never allow a child to put the shoulder belt under an arm or behind their back. In a crash, the shoulder belt will not protect a child properly, which may result in serious injury or death. A child must always wear both the lap and shoulder portions of the seat belt correctly.

Installing Child Restraints In Commercial Vehicles

This commercial vehicle is not designed for use as a family vehicle and is not intended for carrying children. Never install rear-facing child restraints in this vehicle unless your vehicle is equipped with the optional rear bench seats. Although the seat belt can be locked to secure a child restraint, there are no tether anchorages to complete the proper installation of a forward-facing child restraint. If you must carry a child in a forward-facing, the front passenger seat should be moved to the full rearward position and the child must be in a proper restraint system based on its age, size and weight. Follow the instructions below to secure the child restraint using the seat belt.

WARNING!

Rear-facing infant restraints must never be secured in the passenger seat of a vehicle with a passenger air bag. In a collision, a passenger air bag may deploy causing severe injury or death to infants riding in rear-facing infant restraints.

Installing Child Restraints Using The Vehicle Seat Belt

Child restraint systems are designed to be secured in vehicle seats by lap belts or the lap belt portion of a lap/shoulder belt.

WARNING!

- Improper installation or failure to properly secure a child restraint can lead to failure of the restraint. The child could be badly injured or killed.
- Follow the child restraint manufacturer’s directions exactly when installing an infant or child restraint.

The seat belts in some passenger seating positions are equipped with a Switchable Automatic Locking Retractor (ALR). This seat belt is designed to keep the lap portion of the seat belt tight around the child restraint so that it is not necessary to use a locking clip. The ALR retractor can be “switched” into a locked mode by pulling all of the webbing out of the retractor and then letting the webbing retract back into the retractor. If it is locked, the ALR will make a clicking noise while the webbing is pulled back into the retractor. See the “Automatic Locking Mode” description in “Switchable Automatic Locking Retractors (ALR)” ↪ page 170 for additional information on ALR.

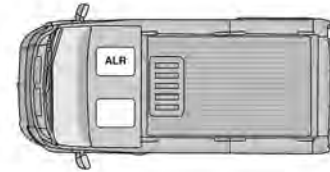

A0503000681US

**Front Bucket Seat Automatic Locking Retractor (ALR)
Location (Gas Models) – If Equipped**

ALR – Switchable Automatic Locking Retractor

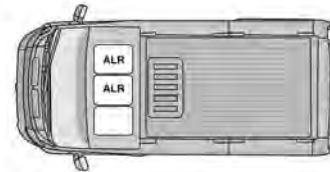

A0503000682US

**Front Bench Seat Automatic Locking Retractor (ALR)
Locations (Gas Models) – If equipped**

ALR – Switchable Automatic Locking Retractor

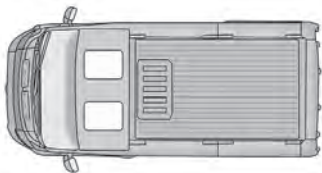

0603202879U5

Front Jump Seat Automatic Locking Retractor (ALR) Location (BEV Models) – If Equipped

ALR – Switchable Automatic Locking Retractor

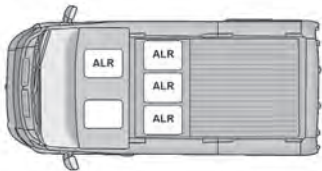

0603202854U5

Front Bucket Seat with Rear Bench Seat Automatic Locking Retractor (ALR) Locations – If equipped

ALR – Switchable Automatic Locking Retractor

Installing A Child Restraint With A Switchable Automatic Locking Retractor (ALR)

Child restraint systems are designed to be secured in vehicle seats by lap belts or the lap belt portion of a lap/shoulder belt.

WARNING!

- Improper installation or failure to properly secure a child restraint can lead to failure of the restraint. The child could be badly injured or killed.
- Follow the child restraint manufacturer's directions exactly when installing an infant or child restraint.

1. Place the child seat in the center of the seating position.
2. Pull enough of the seat belt webbing from the retractor to pass it through the belt path of the child restraint. Do not twist the belt webbing in the belt path.
3. Slide the latch plate into the buckle until you hear a "click."
4. Pull on the webbing to make the lap portion tight against the child seat.
5. To lock the seat belt, pull down on the shoulder part of the belt until you have pulled all the seat belt webbing out of the retractor. Then, allow the webbing to retract back into the retractor. As the webbing retracts, you will hear a clicking sound. This means the seat belt is now in the Automatic Locking mode.

6. Try to pull the webbing out of the retractor. If it is locked, you should not be able to pull out any webbing. If the retractor is not locked, repeat step 5.
7. Finally, pull up on any excess webbing to tighten the lap portion around the child restraint while you push the child restraint rearward and downward into the vehicle seat.
8. Test that the child restraint is installed tightly by pulling back and forth on the child seat at the belt path. It should not move more than 1 inch (25.4 mm) in any direction.

Any seat belt system will loosen with time, so check the belt occasionally, and pull it tight if necessary.

REAR BENCH SEAT – IF EQUIPPED

This vehicle is not equipped with Top Tether Anchors - Do not use forward-facing child restraints.

For rear-facing child restraints, use the lower anchorage system until the combined weight of the child and child restraint is 65 lb (29.5 kg). Use the seat belt instead of the lower anchorage system once the combined weight is more than 65 lb (29.5 kg).

NOTE:

Using the seat belt instead of the lower anchorage system is also acceptable below this combined weight.

Recommendations for Attaching Child Restraints

Restraint Type	Combined Weight of the Child + Child Restraint	Use Any Attachment Method Shown With An "X" Below	
		Lower Anchors Only	Seat Belt Only
Rear-Facing Child Restraint	Up to 65 lb (29.5 kg)	X	X
Rear-Facing Child Restraint	More than 65 lb (29.5 kg)		X
Forward-Facing Child Restraint	Up to 65 lb (29.5 kg)		
Forward-Facing Child Restraint	More than 65 lb (29.5 kg)		

Lower Anchor Positions for Installing Child Restraints in this Vehicle

The bench seat's outboard seating positions have two lower anchorages located at the back of the seat cushion where it meets the seatback. Please see the following table for more information.

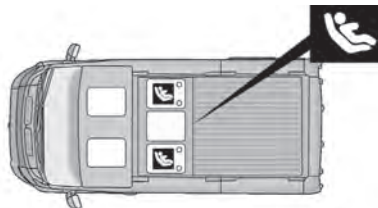

0603202856US

Lower Anchor Positions

 Lower Anchorage Symbol (2 Anchorages Per Seating Position)

Frequently Asked Questions About Installing Child Restraints With Lower Anchors

What is the weight limit (child's weight + weight of the child restraint) for using the lower anchorage system to attach the child restraint?	65 lb (29.5 kg)	For Rear-Facing Child Restraints, use the lower anchorage system until the combined weight of the child and the child restraint is 65 lb (29.5 kg). Use the seat belt instead of the lower anchorage system once the combined weight is more than 65 lb (29.5 kg). For vehicles equipped with a rear bench seat, do not use Forward-Facing Child Restraints in the rear seating positions.
Can the lower anchorages and the seat belt be used together to attach a rear-facing or forward-facing child restraint?	No	Do not use the seat belt when you use the lower anchorage system to attach a child restraint. Do not use forward-facing child restraints. Booster seats may be attached to the lower anchorages if allowed by the booster seat manufacturer. See your booster seat owner's manual for more information.
Can two child restraints be attached using a common lower LATCH anchorage?	No	Never "share" a lower anchorage with two or more child restraints. If the center position does not have dedicated lower anchorages, use the seat belt to install a child seat in the center position next to a child seat using the lower anchorages in an outboard position.
Can the rear-facing child restraint touch the back of the front passenger seat?	Yes	The child seat may touch the back of the front passenger seat if the child restraint manufacturer also allows contact. See your child restraint owner's manual for more information.
Can the rear head restraints be removed?	Yes	The head restraints can be removed if it interferes with the installation of the child restraint → page 43.

Locating the Lower Anchorages

The lower anchorages are round bars that are found at the rear of the seat cushion where it meets the seatback. They are just visible when you lean into the rear seat to install the child restraint. You will easily feel them if you run your finger along the gap between the seatback and seat cushion. If your vehicle is equipped with anchorage symbols on the seatback, they will be located above the lower anchorages

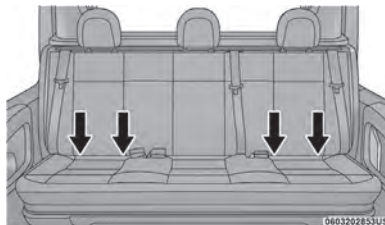

Center Seat Lower Anchor

WARNING!

- Do not install a child restraint in the center position using the Lower Anchorage system. This position does not feature Lower Anchor attachments.
- Never use the same lower anchorage to attach more than one child restraint.

To Install A Lower Anchorage Compatible Child Restraint

The following instructions are intended for rear-facing child seats only. For front or rear facing child seats using the vehicle seat belt, please see "Installing Child Restraints Using the Vehicle Seat Belt" ↗ page 179 for operation instructions.

1. Loosen the adjusters on the lower straps of the child seat so that you can more easily attach the hooks or connectors to the vehicle anchorages.
2. Place the child seat between the lower anchorages for that seating position. You may move the front seat forward to allow more room for the child seat.
3. Attach the lower hooks or connectors of the child restraint to the lower anchorages in the selected seating position.
4. Tighten all of the straps as you push the child restraint rearward and downward into the seat. Remove slack in the straps according to the child restraint manufacturer's instructions.
5. Test that the child restraint is installed tightly by pulling back and forth on the child seat at the belt path. It should not move more than 1 inch (25.4 mm) in any direction.

SAFETY TIPS

TRANSPORTING PASSENGERS

NEVER TRANSPORT PASSENGERS IN THE CARGO AREA.

WARNING!

- Do not leave children or animals inside parked vehicles in hot weather. Interior heat buildup may cause serious injury or death.
- It is extremely dangerous to ride in a cargo area, inside or outside of a vehicle. In a collision, people riding in these areas are more likely to be seriously injured or killed.
- Do not allow people to ride in any area of your vehicle that is not equipped with seats and seat belts.
- Be sure everyone in your vehicle is in a seat and using a seat belt properly.

TRANSPORTING PETS

Air Bags deploying in the front seat could harm your pet. An unrestrained pet will be thrown about and possibly injured, or injure a passenger during panic braking or in a collision.

Pets should be restrained in the rear seat (if equipped) in pet harnesses or pet carriers that are secured by seat belts.

CONNECTED VEHICLES

Privacy of any wireless and wired communications cannot be assured. Third parties may unlawfully intercept information and private communications without your consent. For further information, refer to "Data Collection & Privacy" in your Uconnect Owner's Manual Supplement or "Onboard Diagnostic System (OBD II) Cybersecurity" ↗ page 136.

WARNING!

It is not possible to know or to predict all of the possible outcomes if your vehicle's systems are breached. It may be possible that vehicle systems, including safety related systems, could be impaired or a loss of vehicle control could occur that may result in an accident involving serious injury or death.

SAFETY CHECKS YOU SHOULD MAKE INSIDE THE VEHICLE

Seat Belts

Inspect the seat belt system periodically, checking for cuts, frays, and loose parts. Damaged parts must be replaced immediately. Do not disassemble or modify the system.

If your vehicle is involved in a collision, or if you have questions regarding the seat belt or retractor conditions, take your vehicle to an authorized FCA dealer or authorized FCA Certified Collision Care Program facility for inspection.

Air Bag Warning Light



The Air Bag Warning Light will turn on for four to eight seconds as a bulb check when the ignition switch is first placed in the MAR (ACC/ON/RUN) position. If the light is either not on during starting, stays on, or turns on while driving, have the system inspected at an authorized dealer as soon as possible. After the bulb check, this light will illuminate with a single chime when a fault with the Air Bag System has been detected. It will stay on until the fault is removed. If the light comes on intermittently or remains on while driving, have an authorized dealer service the vehicle immediately → page 165.

Defroster

Check operation by selecting the defrost mode and place the blower control on high speed. You should be able to feel the air directed against the windshield. See an authorized dealer for service if your defroster is inoperable.

Floor Mat Safety Information

Always use floor mats designed to fit your vehicle. Only use a floor mat that does not interfere with the operation of the accelerator, brake or clutch pedals. Only use a floor mat that is securely attached using the floor mat fasteners so it cannot slip out of position and interfere with the accelerator, brake or clutch pedals or impair safe operation of your vehicle in other ways.

WARNING!

An improperly attached, damaged, folded, or stacked floor mat, or damaged floor mat fasteners may cause your floor mat to interfere with the accelerator, brake, or clutch pedals and cause a loss of vehicle control.

To prevent **SERIOUS INJURY** or **DEATH**:

- ALWAYS securely attach your floor mat using the floor mat fasteners. **DO NOT** install your floor mat upside down or turn your floor mat over. Lightly pull to confirm mat is secured using the floor mat fasteners on a regular basis.
- ALWAYS REMOVE THE EXISTING FLOOR MAT FROM THE VEHICLE before installing any other floor mat. NEVER install or stack an additional floor mat on top of an existing floor mat.
- ONLY install floor mats designed to fit your vehicle. NEVER install a floor mat that cannot be properly attached and secured to your vehicle. If a floor mat needs to be replaced, only use a FCA approved floor mat for the specific make, model, and year of your vehicle.
- ONLY use the driver's side floor mat on the driver's side floor area. To check for interference, with the vehicle properly parked with the engine off, fully depress the accelerator, the brake, and the clutch pedal (if present) to check for interference. If your floor mat interferes with the operation of any pedal, or is not secure to the floor, remove the floor mat from the vehicle and place the floor mat in your trunk.
- ONLY use the passenger's side floor mat on the passenger's side floor area.



(Continued)

WARNING!

- ALWAYS make sure objects cannot fall or slide into the driver's side floor area when the vehicle is moving. Objects can become trapped under accelerator, brake, or clutch pedals and could cause a loss of vehicle control.
- NEVER place any objects under the floor mat (e.g., towels, keys, etc.). These objects could change the position of the floor mat and may cause interference with the accelerator, brake, or clutch pedals.
- If the vehicle carpet has been removed and re-installed, always properly attach carpet to the floor and check the floor mat fasteners are secure to the vehicle carpet. Fully depress each pedal to check for interference with the accelerator, brake, or clutch pedals then re-install the floor mats.
- It is recommended to only use mild soap and water to clean your floor mats. After cleaning, always check your floor mat has been properly installed and is secured to your vehicle using the floor mat fasteners by lightly pulling mat.

PERIODIC SAFETY CHECKS YOU SHOULD MAKE OUTSIDE THE VEHICLE

Tires

Examine tires for excessive tread wear and uneven wear patterns. Check for stones, nails, glass, or other objects lodged in the tread or sidewall. Inspect the tread for cuts and cracks. Inspect sidewalls for cuts, cracks, and bulges. Check the lug nut/bolt torque for tightness. Check the tires (including spare) for proper cold inflation pressure.

Lights

Have someone observe the operation of brake lights and exterior lights while you work the controls. Check turn signal and high beam indicator lights on the instrument panel.

Door Latches

Check for proper closing, latching, and locking.

Fluid Leaks

Check area under the vehicle after overnight parking for fuel, coolant, oil, or other fluid leaks. Also, if gasoline fumes are detected or if fuel or brake fluid leaks are suspected, the cause should be located and corrected immediately.

EXHAUST GAS

WARNING!

Exhaust gases can injure or kill. They contain carbon monoxide (CO), which is colorless and odorless. Breathing it can make you unconscious and can eventually poison you. To avoid breathing (CO), follow these safety tips:

- Do not run the engine in a closed garage or in confined areas any longer than needed to move your vehicle in or out of the area.
- If you are required to drive with the trunk/liftgate/rear doors open, make sure that all windows are closed and the climate control BLOWER switch is set at high speed. DO NOT use the recirculation mode.

(Continued)

WARNING!

- If it is necessary to sit in a parked vehicle with the engine running, adjust your heating or cooling controls to force outside air into the vehicle. Set the blower at high speed.

The best protection against carbon monoxide entry into the vehicle body is a properly maintained engine exhaust system.

Whenever a change is noticed in the sound of the exhaust system, when exhaust fumes can be detected inside the vehicle, or when the underside or rear of the vehicle is damaged, have an authorized dealer inspect the complete exhaust system and adjacent body areas for broken, damaged, deteriorated, or mispositioned parts. Open seams or loose connections could permit exhaust fumes to seep into the passenger compartment. In addition, inspect the exhaust system each time the vehicle is raised for lubrication or oil change. Replace as required.

CARBON MONOXIDE WARNINGS

WARNING!

Carbon monoxide (CO) in exhaust gases is deadly. Follow the precautions provided to prevent carbon monoxide poisoning:

- Do not inhale exhaust gases. They contain carbon monoxide, a colorless and odorless gas, which can kill. Never run the engine in a closed area, such as a garage, and never sit in a parked vehicle with the engine running for an extended period. If the

(Continued)

WARNING!

vehicle is stopped in an open area with the engine running for more than a short period, adjust the ventilation system to force fresh, outside air into the vehicle.

- Guard against carbon monoxide with proper maintenance. Have the exhaust system inspected every time the vehicle is raised. Have any abnormal conditions repaired promptly. Until repaired, drive with all side windows fully open.
- When exiting the vehicle, always make sure the ignition is in the OFF position, remove the key fob from the vehicle, and lock your vehicle.

IN CASE OF EMERGENCY

HAZARD WARNING FLASHERS

The Hazard Warning Flashers button is located on the instrument panel below the climate controls.

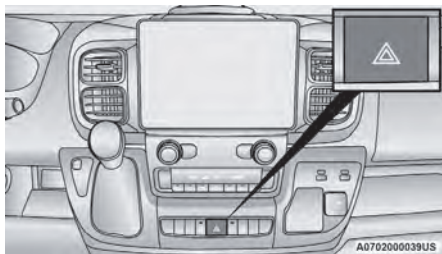

Hazard Warning Flashers Button

Push the button to turn on the Hazard Warning Flashers. When the button is activated, all directional turn signals will flash on and off to warn oncoming traffic of an emergency. Push the button a second time to turn off the Hazard Warning Flashers.

This is an emergency warning system and it should not be used when the vehicle is in motion. Use it only when your vehicle is disabled or signaling a safety hazard warning for other motorists.

When you must leave the vehicle to seek assistance, the Hazard Warning Flashers will continue to operate even though the ignition is placed in the OFF position.

NOTE:

With extended use, the Hazard Warning Flashers may wear down your battery.

SOS AND ASSIST SYSTEM



Assist And SOS Buttons

- 1 – SOS Button
2 – ASSIST Button

The overhead console contains an SOS and ASSIST button.

WARNING!

ALWAYS obey traffic laws and pay attention to the road. ALWAYS drive safely with your hands on the steering wheel. You have full responsibility and assume all risks related to the use of the features and applications in this vehicle. Only use the features and applications when it is safe to do so. Failure to do so may result in an accident involving serious injury or death.

NOTE:

- Your vehicle may be transmitting data as authorized by the subscriber → page 269.
- The SOS and ASSIST buttons will only function if you are connected to an operable LTE (voice/data) or 4G (data) network, which comes as a built in function. Other Uconnect services will only be operable if your SiriusXM Guardian™ service is active and connected to an operable LTE (voice/data) or 4G (data) network.

SOS Call

- Push the SOS Call button on the overhead console.

NOTE:

In case the SOS Call button is pushed in error, there will be a ten second delay before the SOS Call system initiates a call to an SOS operator. To cancel the SOS Call connection, push the SOS Call button on the overhead console or press the cancellation button on the Device Screen. Termination of the SOS Call will turn off the green LED light on the overhead console.

2. The LED lights located within the SOS and ASSIST buttons on the overhead console will turn green once a connection to an SOS operator has been made.
3. Once a connection between the vehicle and an SOS operator is made, the SOS Call system may transmit the following important vehicle information to an SOS operator:
 - Indication that the occupant placed an SOS Call
 - The vehicle brand
 - The last known GPS coordinates of the vehicle
4. You should be able to speak with the SOS operator through the vehicle audio system to determine if additional help is needed.

WARNING!

ALWAYS obey traffic laws and pay attention to the road. ALWAYS drive safely with your hands on the steering wheel. You have full responsibility and assume all risks related to the use of the features and applications in this vehicle. Only use the features and applications when it is safe to do so. Failure to do so may result in an accident involving serious injury or death.

NOTE:

- Your vehicle may be transmitting data as authorized by the subscriber.
 - Once a connection is made between the vehicle's SOS Call system and the SOS operator, the SOS operator may be able to open a voice connection with the vehicle to determine if additional help is needed. Once the SOS operator opens a voice connection with the vehicle's SOS Call system, the operator should be able to speak with you or other vehicle occupants and hear sounds occurring in the vehicle. The vehicle's SOS Call system will attempt to remain connected with the SOS operator until the SOS operator terminates the connection.
5. The SOS operator may attempt to contact appropriate emergency responders and provide them with important vehicle information and GPS coordinates.

WARNING!

- If anyone in the vehicle could be in danger (e.g., fire or smoke is visible, dangerous road conditions or location), do not wait for voice contact from an Emergency Services Agent. All occupants should exit the vehicle immediately and move to a safe location.
- Never place anything on or near the vehicle's operable network and GPS antennas. You could prevent operable network and GPS signal reception, which can prevent your vehicle from placing an emergency call. An operable network and GPS signal reception is required for the SOS Call system to function properly.

(Continued)

WARNING!

- The SOS Call system is embedded into the vehicle's electrical system. Do not add aftermarket electrical equipment to the vehicle's electrical system. This may prevent your vehicle from sending a signal to initiate an emergency call. To avoid interference that can cause the SOS Call system to fail, never add aftermarket equipment (e.g., two-way mobile radio, CB radio, data recorder, etc.) to your vehicle's electrical system or modify the antennas on your vehicle. IF YOUR VEHICLE LOSES BATTERY POWER FOR ANY REASON (INCLUDING DURING OR AFTER AN ACCIDENT), THE UCONNECT FEATURES, APPS AND SERVICES, AMONG OTHERS, WILL NOT OPERATE.
- Modifications to any part of the SOS Call system could cause the air bag system to fail when you need it. You could be injured if the air bag system is not there to help protect you.

SOS Call System Limitations

Vehicles sold in Mexico **DO NOT** have SOS Call system capabilities.

SOS or other emergency line operators in Mexico may not answer or respond to SOS system calls.

If the SOS Call system detects a malfunction, any of the following may occur at the time the malfunction is detected, and at the beginning of each ignition cycle:

- The overhead console lights located within the SOS and ASSIST buttons will continuously illuminate red.
- The Device Screen will display the following message: "Vehicle device requires service. Please contact an authorized dealer."

- An In-Vehicle Audio message will state “Vehicle device requires service. Please contact an authorized dealer.”

WARNING!

- Ignoring the overhead console light could mean you will not have SOS Call services. If the overhead console light is illuminated, have an authorized dealer service the SOS Call system immediately.
- The Occupant Restraint Control module turns on the air bag Warning Light on the instrument panel if a malfunction in any part of the system is detected. If the Air Bag Warning Light is illuminated, have an authorized dealer service the Occupant Restraint Control system immediately.

Even if the SOS Call system is fully functional, factors beyond FCA US LLC’s control may prevent or stop the SOS Call system operation. These include, but are not limited to, the following factors:

- The ignition is in the OFF position
- The vehicle’s electrical systems are not intact
- The SOS Call system software and/or hardware are damaged during a crash
- The vehicle battery loses power or becomes disconnected during a vehicle crash
- LTE (voice/data) or 4G (data) network and/or Global Positioning Satellite signals are unavailable or obstructed
- Equipment malfunction at the SOS operator facility
- Operator error by the SOS operator

- LTE (voice/data) or 4G (data) network congestion
- Weather
- Buildings, structures, geographic terrain, or tunnels

WARNING!

ALWAYS obey traffic laws and pay attention to the road. ALWAYS drive safely with your hands on the steering wheel. You have full responsibility and assume all risks related to the use of the features and applications in this vehicle. Only use the features and applications when it is safe to do so. Failure to do so may result in an accident involving serious injury or death.

NOTE:

- Your vehicle may be transmitting data as authorized by the subscriber.
- Never place anything on or near the vehicle’s LTE (voice/data) or 4G (data) and GPS antennas. You could prevent LTE (voice/data) or 4G (data) and GPS signal reception, which can prevent your vehicle from placing an emergency call. An operable LTE (voice/data) or 4G (data) network connection and a GPS signal is required for the SOS Call system to function properly.

NOTE:

Changes or modifications not expressly approved by the party responsible for compliance could void the user’s authority to operate the equipment.

CAUTION!

To avoid damage to the mirror during cleaning, never spray any cleaning solution directly onto the mirror. Apply the solution onto a clean cloth and wipe the mirror clean.

Automatic SOS — If Equipped

Automatic SOS is a hands-free safety service that can immediately connect you with help in the event that your vehicle’s airbags deploy. Please refer to your provided radio supplement for complete information.

ASSIST Call

The ASSIST button is used to automatically connect you to any one of the following support centers:

- Roadside Assistance – If you get a flat tire, or need a tow, just push the ASSIST button to be connected to someone who can help. Roadside Assistance will know what vehicle you’re driving and its location. Additional fees may apply for roadside assistance.
- SiriusXM Guardian™ Customer Care – In-vehicle support for SiriusXM Guardian™.
- Vehicle Customer Care – Total support for all other vehicle issues.
- Uconnect Customer Care – Total support for Radio, Phone and NAV issues.

JACKING AND TIRE CHANGING — IF EQUIPPED

Use this QR code to access your digital experience.



WARNING!

- Do not attempt to change a tire on the side of the vehicle close to moving traffic. Pull far enough off the road to avoid the danger of being hit when operating the jack or changing the wheel.
- Being under a jacked-up vehicle is dangerous. The vehicle could slip off the jack and fall on you. You could be crushed. Never put any part of your body under a vehicle that is on a jack. If you need to get under a raised vehicle, take it to a service center where it can be raised on a lift.
- Never start or run the engine while the vehicle is on a jack.
- The jack is designed to be used as a tool for changing tires only. The jack should not be used to lift the vehicle for service purposes. The vehicle should be jacked on a firm level surface only. Avoid ice or slippery areas.

PREPARATIONS FOR JACKING

1. Park the vehicle on a firm, level surface. Avoid ice or slippery areas.

WARNING!

Do not attempt to change a tire on the side of the vehicle close to moving traffic. Pull far enough off the road to avoid being hit when operating the jack or changing the wheel.

2. Turn on the Hazard Warning Flashers.
3. Apply the parking brake firmly.
4. Place the transmission in PARK (P) or REVERSE (R) for manual transmission.
5. Turn the ignition OFF.
6. Block both front and rear of the wheel diagonally opposite of the jacking position. For example, if the driver's front wheel is being changed, block the passenger's rear wheel.

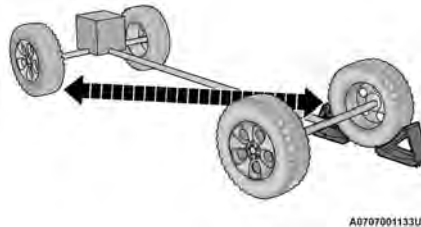

A0707001133US

Wheel Blocked Example

NOTE:

Passengers should not remain in the vehicle when the vehicle is being lifted or raised.

JACK AND TOOLS LOCATION

Depending on vehicle trim level, the jack and tools are stored under the front passenger seat in a box, or strapped behind the driver seat in a tool bag. Tools may vary.

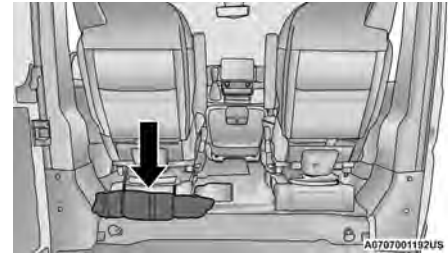

Jack Tool Bag Location — If Equipped

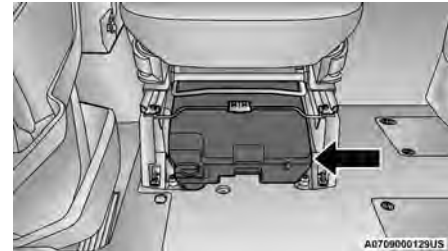

Jack Kit Location — If Equipped

To release the jack kit from its storage location, turn the lock knob a quarter turn counterclockwise to the unlock position.

CAUTION!

Do not force lock knob over limit. Damage to lock knob may occur.

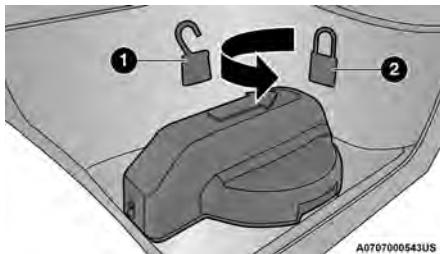
**Lock Knob**

- 1 – Unlock Position
- 2 – Lock Position

To open the jack kit container, you must push the container's release to separate the top and bottom.

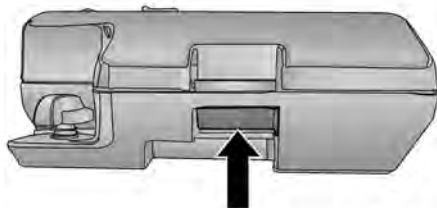

A0707000540US

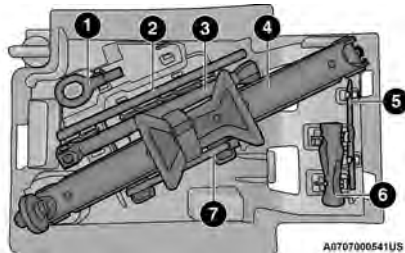
Container Release

A0707000541US

Jacking Tools

- 1 – Tow Eye – If Equipped
- 2 – Wrench Handle
- 3 – Lug Bolt Adapter
- 4 – Jack
- 5 – Reversible Tool – If Equipped
- 6 – Tool Handle – If Equipped
- 7 – Winch Extension

SPARE TIRE REMOVAL

1. Remove the spare tire before attempting to jack up the vehicle. Attach the lug bolt adapter to the winch extension and insert it into the winch mechanism.

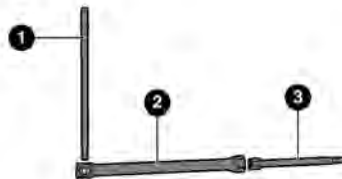

A0707000544US

Jack Tools

- 1 – Wrench Handle
- 2 – Lug Bolt Adapter
- 3 – Winch Extension

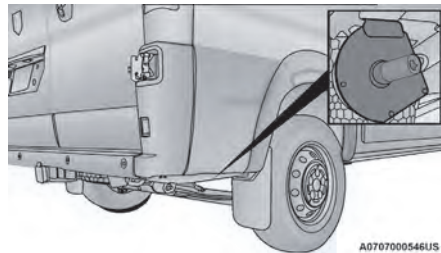

A0707000546US

Winch Location

The winch mechanism is located under the rear of the vehicle in between the right rear tire and spare tire.

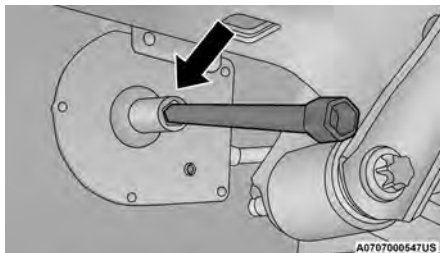

Winch Extension

2. Rotate the wheel wrench handle counterclockwise until the spare tire is on the ground with enough cable slack to allow you to pull it out from under the vehicle.

CAUTION!

The winch mechanism is designed for use with the jack wrench extension tool only. Use of air wrench or power tool may damage the winch.

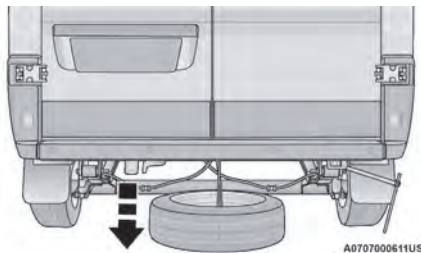

Lowering Spare Tire

3. Pull the spare tire out from under the vehicle to gain access to the spare tire retainer.

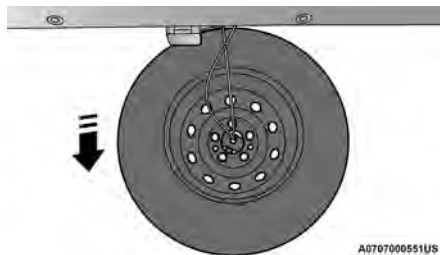

Spare Tire

4. Lift the spare tire with one hand to give clearance to tilt the retainer at the end of the cable.

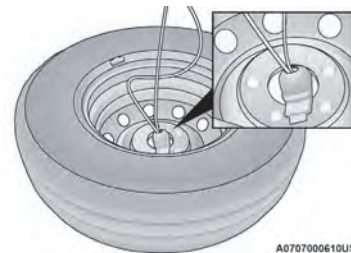

Lifting Spare Tire

5. Pull the retainer through the center of the wheel.

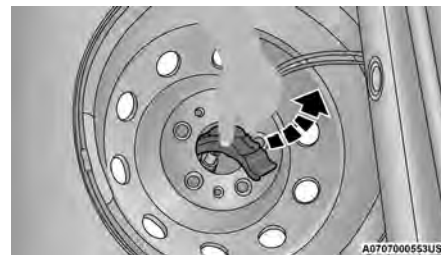

Retainer

JACKING INSTRUCTIONS

WARNING!

Carefully follow these tire changing warnings to help prevent personal injury or damage to your vehicle:

- Always park on a firm, level surface as far from the edge of the roadway as possible before raising the vehicle.
- Turn on the Hazard Warning Flashers.
- Apply the parking brake firmly and place an automatic transmission in PARK; a manual transmission in REVERSE.
- Block the wheel diagonally opposite of the wheel that is to be raised.
- Never start or run the engine with the vehicle on a jack.
- Do not let anyone sit in the vehicle when it is on a jack.
- Do not get under the vehicle when it is on a jack. If you need to get under a raised vehicle, take it to a service center where it can be raised on a lift.
- Only use the jack in the positions indicated and for lifting this vehicle during a tire change.
- If working on or near a roadway, be extremely careful of motor traffic.
- To assure that spare tires, flat or inflated, are securely stowed, spares must be stowed with the valve stem facing the ground.



Jack Warning Label



A0707000555US

Assembled Jack

1. Loosen (but do not remove) the wheel lug bolts by turning them counterclockwise one turn while the wheel is still on the ground.
2. There are two jack engagement locations on each side of the vehicle body. The length of the jack engagement brackets may differ on gas and BEV vehicles.

CAUTION!

Do not attempt to raise the vehicle by jacking on locations other than those indicated in the Jacking Instructions for this vehicle.



A0707001075US

Jacking Engagement Locations

NOTE:

The front jacking location is located behind the front tire and in front of the driver/passenger door.

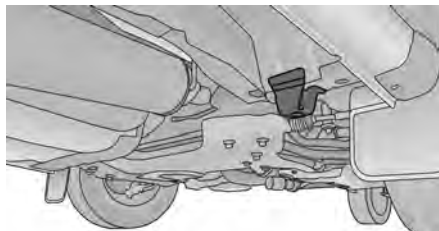

A0707000560US

Front Lifting Point

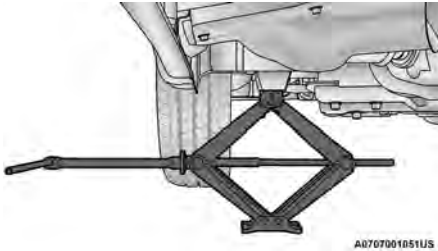

Front Jacking Location

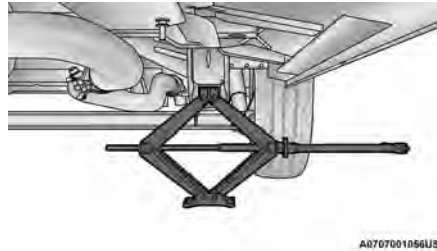

Rear Jacking Location

NOTE:

The rear jacking location is located in front of the rear tire and in front of the leaf spring mount.

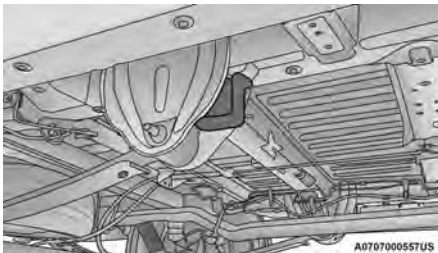

Rear Lifting Point

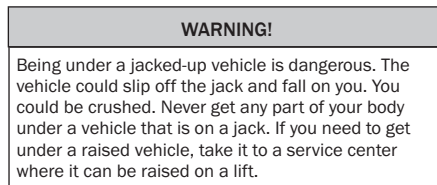
**WARNING!**

Being under a jacked-up vehicle is dangerous. The vehicle could slip off the jack and fall on you. You could be crushed. Never get any part of your body under a vehicle that is on a jack. If you need to get under a raised vehicle, take it to a service center where it can be raised on a lift.

- Place the wrench handle and lug bolt adapter on the jack screw and turn clockwise until the jack head is properly engaged in the described location. **Do not raise the vehicle until you are sure the jack is securely engaged.**
- Raise the vehicle by turning the jack screw clockwise, using the wrench handle and lug bolt adapter. Raise the vehicle only until the tire just clears the surface and enough clearance is obtained to install the spare tire. Minimum tire lift provides maximum stability.

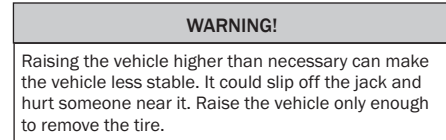
**WARNING!**

Raising the vehicle higher than necessary can make the vehicle less stable. It could slip off the jack and hurt someone near it. Raise the vehicle only enough to remove the tire.

- Remove the wheel lug bolts. For vehicles with wheel covers, remove the cover from the wheel by hand. Do not pry the wheel cover off. Then pull the wheel off the hub.
- Install the spare tire. Lightly tighten the wheel lug bolts.

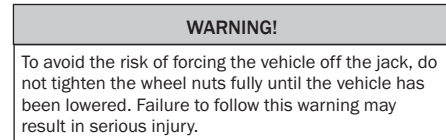
**WARNING!**

To avoid the risk of forcing the vehicle off the jack, do not tighten the wheel nuts fully until the vehicle has been lowered. Failure to follow this warning may result in serious injury.

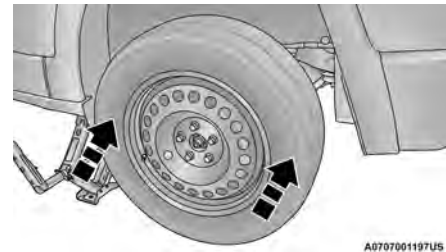

Mounting Spare Tire

CAUTION!

Be sure to mount the spare tire with the valve stem facing outward. The vehicle could be damaged if the spare tire is mounted incorrectly.

NOTE:

Do not install the wheel cover on the spare tire.

- Lower the vehicle by turning the jack screw left, making sure it is securely on the ground. Tighten the lug nuts/bolts in a star pattern until each nut/bolt has been tightened twice. Ensure that the socket is fully engaged on the lug nut/bolt (do not insert it halfway) → page 261.

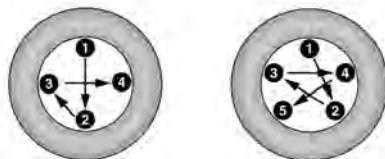

A0910000005US

Torque Patterns

- Lower the jack to its fully-closed position.
- Stow the damaged wheel/spare tire by reinstalling the wheel retainer and using the cable winch mechanism to securely tighten under the vehicle before driving.

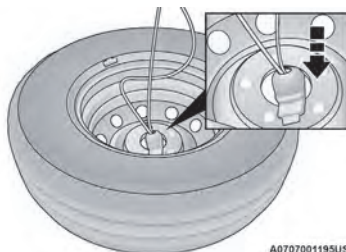

A0707001195US

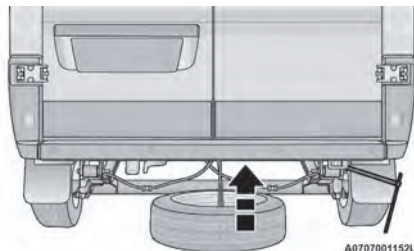
Reinstalling The Retainer

A0707001152US

Damaged Wheel Stowage

- Install the winch extension and rotate the wrench handle clockwise until the winch mechanism operator hears "three clicks" from the device to indicate the wheel is properly stowed under the vehicle.
- Stow the jack, jack handle and winch handle tools back in the storage compartment.

WARNING!

A loose tire or jack thrown forward in a collision or hard stop could endanger the occupants of the vehicle. Always stow the jack parts and the spare tire in the places provided. Have the deflated (flat) tire repaired or replaced immediately.

- Check the spare tire pressure as soon as possible. Correct the tire pressure, as required.

For vehicles with aluminum wheels:

The center cap must be pushed out from the rear to install the retainer and stow the tire.

WHEEL COVERS

The wheel covers on the vehicle are held in place by the wheel lug bolts and can be removed after the wheel lug bolts are taken off.

CAUTION!

Use a back-and-forth motion to remove the hub cap. Do not use a twisting motion when removing the hub cap, damage to the hub cap finish may occur.

TIRE SERVICE KIT — IF EQUIPPED

Use this QR code to access your digital experience.

Depending on vehicle trim level, tire service kit models may vary.



Scan me

Small punctures up to 1/4 inch (6 mm) in the tire tread can be sealed with the Tire Service Kit. Foreign objects (e.g., screws or nails) should not be removed from the tire. The Tire Service Kit can be used in outside temperatures down to approximately -4 °F (-20 °C).

This kit will provide a temporary tire seal, allowing you to drive your vehicle up to 100 miles (160 km) with a maximum speed of 50 mph (80 km/h).

Tire Service Kit Components And Operation

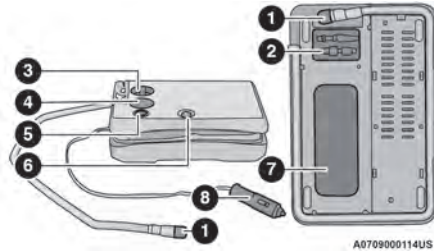

Tire Service Kit Components

- 1 – Sealant/Air Hose
- 2 – Hose Accessories
- 3 – Mode Select Knob
- 4 – Pressure Gauge
- 5 – Deflation Button
- 6 – Power Switch
- 7 – Sealant Bottle
- 8 – Power Plug

Using The Mode Select Knob And Hoses

Your Tire Service Kit is equipped with the following symbols to indicate the air or sealant mode.

● Selecting Air Mode

Push in the Mode Select Knob and turn to this position for air pump operation only.



● Selecting Sealant Mode

Push in the Mode Select Knob and turn to this position to inject the Tire Service Kit Sealant and to inflate the tire.



● Using The Power Button

Push and release the Power Button once to turn on the Tire Service Kit. Push and release the Power Button again to turn off the Tire Service Kit.



● Using The Deflation Button

Push the Deflation Button to reduce the air pressure in the tire if it becomes overinflated.



Tire Service Kit Usage Precautions

- Replace the Tire Service Kit Sealant Bottle prior to the expiration date (printed at the lower right hand corner on the bottle label) to assure optimum operation of the system. See the Sealant Bottle Replacement in this section for further information.
- The Sealant Bottle is a one tire application use and needs to be replaced after each use. Always replace these components immediately at your original equipment vehicle dealer.
- When the Tire Service Kit sealant is in a liquid form, clean water, and a damp cloth will remove the material from the vehicle or tire and wheel components. Once the sealant dries, it can easily be peeled off and properly discarded.
- For optimum performance, make sure the valve stem on the wheel is free of debris before connecting the Tire Service Kit.

- The Tire Service Kit Sealant is only intended to seal punctures less than 1/4 inch (6 mm) diameter in the tread/contact surface of your vehicle's tires.
- The Tire Service Kit Sealant is not intended to seal punctures on the tires' side walls.
- You can use the Tire Service Kit air pump to inflate bicycle tires. The kit also comes with two needles, located in the Accessory Storage Compartment (on the bottom of the air pump) for inflating sport balls, rafts, or similar inflatable items. However, use only the Air Pump and make sure the Mode Select Knob is in the Air Mode when inflating such items to avoid injecting sealant into them.
- Do not lift or carry the Tire Service Kit by the hoses.

WARNING!

- Do not attempt to seal a tire on the side of the vehicle closest to traffic. Pull far enough off the road to avoid the danger of being hit when using the Tire Service Kit.
- Do not use Tire Service Kit or drive the vehicle under the following circumstances:
 - If the puncture in the tire tread is approximately 1/4 inch (6 mm) or larger.
 - If the tire has any sidewall damage.
 - If the tire has any damage from driving with extremely low tire pressure.
 - If the tire has any damage from driving on a flat tire.
 - If the wheel has any damage.
 - If you are unsure of the condition of the tire or the wheel.
- Keep Tire Service Kit away from open flames or heat source.

(Continued)

WARNING!

- A loose Tire Service Kit thrown forward in a collision or hard stop could endanger the occupants of the vehicle. Always stow the Tire Service Kit in the place provided. Failure to follow these warnings can result in injuries that are serious or fatal to you, your passengers, and others around you.
- Take care not to allow the contents of Tire Service Kit to come in contact with hair, eyes, or clothing. Tire Service Kit sealant is harmful if inhaled, swallowed, or absorbed through the skin. It causes skin, eye, and respiratory irritation. Flush immediately with plenty of water if there is any contact with eyes or skin. Change clothing as soon as possible, if there is any contact with clothing.
- Tire Service Kit Sealant solution contains latex. In case of an allergic reaction or rash, consult a physician immediately. Keep Tire Service Kit out of reach of children. If swallowed, rinse mouth immediately with plenty of water and drink plenty of water. Do not induce vomiting! Consult a physician immediately.

Sealing A Tire With Tire Service Kit

Whenever You Stop To Use Tire Service Kit:

1. Pull over to a safe location and turn on the vehicle's Hazard Warning Flashers.
2. Verify that the valve stem (on the wheel with the deflated tire) is in a position that is near to the ground. This will allow the Tire Service Kit Hose to reach the valve stem and keep the Tire Service Kit flat on the ground. This will provide the best positioning of the kit when injecting the sealant into the

deflated tire and running the air pump. Move the vehicle as necessary to place the valve stem in this position before proceeding.

3. Place the gear selector in PARK, then push and release the ENGINE START/STOP button to set the ignition switch to the OFF position.

4. Apply the parking brake.

Setting Up To Use Tire Service Kit:

1. Uncoil the Sealant Hose and then remove the cap from the fitting at the end of the hose.
2. Place the Tire Service Kit flat on the ground next to the deflated tire.
3. Remove the cap from the valve stem and then screw the fitting at the end of the Sealant Hose onto the valve stem.
4. Uncoil the Power Plug and insert the plug into the vehicle's 12 Volt power outlet.

**NOTE:**

Do not remove foreign objects (e.g., screws or nails) from the tire.

Injecting Tire Service Kit Sealant Into The Deflated Tire:

1. Always start the vehicle before turning the Tire Service Kit on.
2. Ensure the Mode Select Knob is in the Sealant Mode position.



3. After pushing the Power Button, the sealant (white fluid) will flow from the Sealant Bottle through the Sealant Hose and into the tire.

**NOTE:**

Sealant may leak out through the puncture in the tire.

If the sealant (white fluid) does not flow within 0 – 10 seconds through the Sealant Hose:

1. Push the Power Button to turn the Tire Service Kit off. Disconnect the Sealant Hose from the valve stem. Make sure the valve stem is free of debris. Reconnect the Sealant Hose to the valve stem. Check that the Mode Select Knob is in the Sealant Mode position and not Air Mode. Push the Power Button to turn the Tire Service Kit on.
2. Connect the Power Plug to a different 12 Volt power outlet in your vehicle or another vehicle, if available. Make sure the vehicle is running before turning the Tire Service Kit on.
3. The Sealant Bottle may be empty due to previous use. Call for assistance.

If the sealant (white fluid) does flow through the Sealant Hose:

1. Continue to operate the pump until sealant is no longer flowing through hose (typically takes 30 - 70 seconds). As the sealant flows through the Sealant Hose, the Pressure Gauge can read as high as 70 psi (4.8 bar). The Pressure Gauge will decrease quickly from approximately 70 psi (4.8 bar) to the actual tire pressure when the Sealant Bottle is empty.



2. The pump will start to inject air into the tire immediately after the Sealant Bottle is empty. Continue to operate the pump and inflate the tire to the cold tire inflation pressure found on the tire and loading information label located in the driver-side door opening. Check the tire pressure by looking at the Pressure Gauge.



If the tire does not inflate to at least 26 psi (1.8 bar) within 15 minutes:

- The tire is too badly damaged. Do not attempt to drive the vehicle further. Call for assistance.

If the tire inflates to the recommended pressure or is at least 26 psi (1.8 bar) within 15 minutes:

NOTE:

If the tire becomes overinflated, push the Deflation Button to reduce the tire pressure to the recommended inflation pressure before continuing.

1. Push the Power Button to turn the Tire Service Kit off.



2. Remove the speed limit label from the Tire Service Kit and place sticker on the steering wheel.



3. Immediately disconnect the Sealant Hose from the valve stem, reinstall the cap on the fitting at the end of the hose, and place the Tire Service Kit in the vehicle storage location.

Drive Vehicle:



Immediately after injecting sealant and inflating the tire, drive the vehicle 5 miles (8 km) or 10 minutes to ensure distribution of the Tire Service Kit Sealant within the tire. Do not exceed 50 mph (80 km/h).

WARNING!

The Tire Service Kit is not a permanent flat tire repair. Have the tire inspected and repaired or replaced after using the Tire Service Kit. Do not exceed 50 mph (80 km/h) until the tire is repaired or replaced. Failure to follow this warning can result in injuries that are serious or fatal to you, your passengers, and others around you. Have the tire checked as soon as possible at an authorized dealer.

After Driving:

- Pull over to a safe location and turn on the vehicle's Hazard Warning Flashers.
- Verify that the valve stem (on the wheel with the deflated tire) is in a position that is near to the ground. This will allow the Tire Service Kit Hose to reach the valve stem and keep the Tire Service Kit flat on the ground. This will provide the best positioning of the kit when injecting the sealant into the deflated tire and running the air pump. Move the vehicle as necessary to place the valve stem in this position before proceeding.
- Place the transmission in PARK (P) and cycle the ignition in the OFF position.
- Apply the parking brake.

NOTE:

If tire has improper inflation follow these next steps:

1. Uncoil the Sealant Hose, and then remove the cap from the fitting at the end of the hose.
2. Place the Tire Service Kit flat on the ground next to the deflated tire



3. Remove the cap from the valve stem, and then screw the fitting at the end of the Sealant Hose onto the valve stem.

4. Uncoil the Power Plug and insert the plug into the vehicle's 12 Volt power outlet.



5. Uncoil the Hose and screw the fitting at the end of the hose onto the valve stem.



6. Turn the Mode Select Knob to the Air Mode position.



7. Check the pressure in the tire by reading the Pressure Gauge.

If tire pressure is less than 19 psi (1.3 bar):

The tire is too badly damaged. Do not attempt to drive the vehicle further. Call for assistance.

If the tire pressure is 19 psi (1.3 bar) or higher:

1. Push the Power Button to turn on Tire Service Kit and inflate the tire to the cold tire inflation pressure found on the tire and loading information label located in the driver-side door opening.

**NOTE:**

If the tire becomes overinflated, push the Deflation Button to reduce the tire pressure to the recommended inflation pressure before continuing.

2. Disconnect the Tire Service Kit from the valve stem, reinstall the cap on the valve stem and unplug from 12 Volt outlet.
3. Place the Tire Service Kit in its proper storage area in the vehicle.
4. Have the tire inspected and repaired or replaced at the earliest opportunity at an authorized dealer or tire service center.
5. Remove the Speed Limit sticker from the steering wheel after the tire has been repaired.
6. Replace the Sealant Bottle at an authorized dealer as soon as possible.

NOTE:

When having the tire serviced, advise the authorized dealer or service center that the tire has been sealed using the Tire Service Kit.

Sealant Bottle Replacement:

1. Unwrap the power cord.
2. Unwrap the hose.

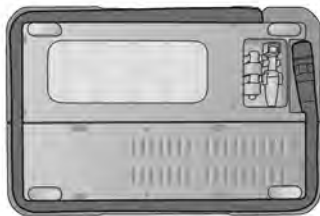

A0709000070US

Hose Location

3. Remove the bottle cover.

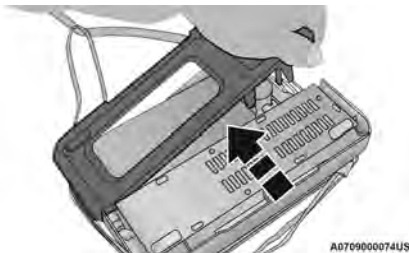

A0709000074US

Remove The Bottle Cover

4. Rotate the bottle up beyond vertical to release.

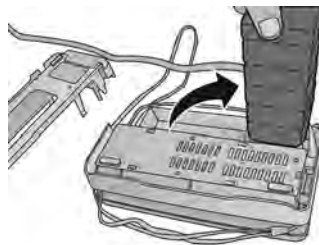

A0709000075US

Rotate The Bottle Up

5. Pull the bottle away from the Compressor.

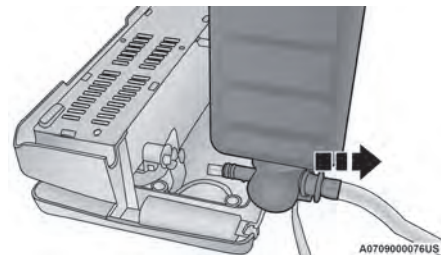

A0709000076US

Remove The Bottle**NOTE:**

- For sealant bottle installation, follow these steps in reverse order.

- The Sealant Bottle is a one tire application use and needs to be replaced after each use. Always replace these components immediately at your original equipment vehicle dealer.
- Replace the Tire Service Kit Sealant Bottle prior to the expiration date (printed on the bottle label) to ensure optimum operation of the system.

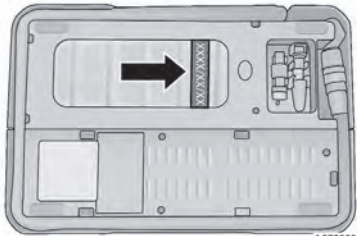

Sealant Bottle Expiration Date Location

WARNING!

As required by current regulations, the information on chemical substances for the protection of human health and the environment and on the safe use of the sealing fluid are on the packaging label. Compliance with the indications on the label is an essential condition to ensure the safety and effectiveness of the product. Remember to carefully read the label

(Continued)

WARNING!

before use. The user of the product is responsible for any damages caused by improper use. The sealing fluid has an expiration date. Replace the bottle if the sealant has expired.

CAUTION!

Dispose of the bottle and the sealant liquid properly. Have them disposed of in compliance with national and local regulations.

ALTERNATE TIRE SERVICE KIT – IF EQUIPPED

Depending on vehicle trim levels, the Tire Service Kit designs may vary and can be stored in the driver's door pocket or the passenger's side compartment area.

TIRE SERVICE KIT COMPONENTS AND OPERATION

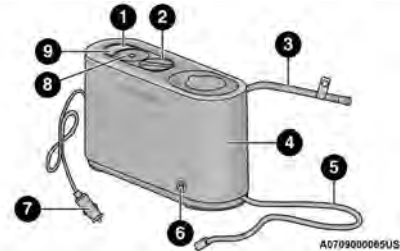

Tire Service Kit Components

- 1 – Power Button
- 2 – Mode Select Knob
- 3 – Sealant Hose (Clear)
- 4 – Sealant Bottle
- 5 – Air Pump Hose (Black)
- 6 – Sealant Bottle Release Button
- 7 – Power Plug
- 8 – Pressure Gauge
- 9 – Deflation Button

Using the Mode Select Knob And Hoses

Your Tire Service Kit is equipped with the following symbols:

- **Selecting Air Mode**

Push in the Mode Select Knob and turn to this position for air pump operation only. Use the black Air Pump Hose when selecting this mode.



- **Selecting Sealant Mode**

Push in the Mode Select Knob and turn to this position to inject the Tire Service Kit Sealant and to inflate the tire. Use the Sealant Hose when selecting this mode.



- **Using The Power Button**

Push and release the Power Button once to turn on the Tire Service Kit. Push and release the Power Button again to turn off the Tire Service Kit.



- **Using The Deflation Button**

Push the Deflation Button to reduce the air pressure in the tire if it becomes overinflated.



TIRE SERVICE KIT USAGE PRECAUTIONS

- The Sealant Bottle and Sealant Hose are a one tire application use and need to be replaced after each use. Always replace these components immediately at your original equipment vehicle dealer.
- When the Tire Service Kit sealant is in a liquid form, clean water and a damp cloth will remove the material from the vehicle or tire and wheel components. Once the sealant dries, it can easily be peeled off and properly discarded.
- For optimum performance, make sure the valve stem on the wheel is free of debris before connecting the Tire Service Kit.
- You can use the Tire Service Kit air pump to inflate bicycle tires. The kit also comes with two needles, located in the Accessory Storage Compartment (on the bottom of the air pump) for inflating sport balls, rafts, or similar inflatable items. However, use only the Air Pump Hose and make sure the Mode Select

Knob is in Air Mode when inflating such items to avoid injecting sealant into them. The Tire Service Kit Sealant is only intended to seal punctures less than 1/4 inch (6 mm) diameter in the tread of your tire.

- Do not lift or carry the Tire Service Kit by the hoses.

WARNING!

- Do not attempt to seal a tire on the side of the vehicle closest to traffic. Pull far enough off the road to avoid the danger of being hit when using the Tire Service Kit.
- Do not use Tire Service Kit or drive the vehicle under the following circumstances:
 - If the puncture in the tire tread is approximately 1/4 inch (6 mm) or larger.
 - If the tire has any sidewall damage.
 - If the tire has any damage from driving with extremely low tire pressure.
 - If the tire has any damage from driving on a flat tire.
 - If the wheel has any damage.
 - If you are unsure of the condition of the tire or the wheel.
- Keep Tire Service Kit away from open flames or heat sources.
- A loose Tire Service Kit thrown forward in a collision or hard stop could endanger the occupants of the vehicle. Always stow the Tire Service Kit in the place provided. Failure to follow these warnings can result in injuries that are serious or fatal to you, your passengers, and others around you.
- Take care not to allow the contents of Tire Service Kit to come in contact with hair, eyes, or clothing. Tire Service Kit sealant is harmful if inhaled, swal-

(Continued)

WARNING!

lowed, or absorbed through the skin. It causes skin, eye, and respiratory irritation. Flush immediately with plenty of water if there is any contact with eyes or skin. Change clothing as soon as possible, if there is any contact with clothing.

- Tire Service Kit Sealant solution contains latex. In case of an allergic reaction or rash, consult a physician immediately. Keep Tire Service Kit out of reach of children. If swallowed, rinse mouth immediately with plenty of water and drink plenty of water. Do not induce vomiting! Consult a physician immediately.

SEALING A TIRE WITH TIRE SERVICE KIT

(A) Whenever You Stop To Use Tire Service Kit:

1. Pull over to a safe location and turn on the vehicle's Hazard Warning Flashers.
2. Verify that the valve stem (on the wheel with the deflated tire) is in a position that is near to the ground. This will allow the Tire Service Kit Hoses and to reach the valve stem and keep the Tire Service Kit flat on the ground. This will provide the best positioning of the kit when injecting the sealant into the deflated tire and running the air pump. Move the vehicle as necessary to place the valve stem in this position before proceeding.
3. Place the transmission in PARK (P) (auto transmission) or in Gear (manual transmission) and place the ignition in the OFF position.
4. Apply the parking brake.

(B) Setting Up To Use Tire Service Kit:

1. Push in the Mode Select Knob and turn to the Sealant Mode position.
2. Uncoil the Sealant Hose and then remove the cap from the fitting at the end of the hose.
3. Place the Tire Service Kit flat on the ground next to the deflated tire.
4. Remove the cap from the valve stem and then screw the fitting at the end of the Sealant Hose onto the valve stem.
5. Uncoil the Power Plug and insert the plug into the vehicle's 12 Volt power outlet.

NOTE:

Do not remove foreign objects (e.g., screws or nails) from the tire.

(C) Injecting Tire Service Kit Sealant Into The Deflated Tire:

- Always start the engine before turning on the Tire Service Kit.

NOTE:

Manual transmission vehicles must have the parking brake engaged and the gear selector in NEUTRAL.

- After pushing the Power Button, the sealant (white fluid) will flow from the Sealant Bottle through the Sealant Hose and into the tire.

NOTE:

Sealant may leak out through the puncture in the tire.

If the sealant (white fluid) does not flow within 0 – 10 seconds through the Sealant Hose (3):

1. Push the Power Button to turn off the Tire Service Kit. Disconnect the Sealant Hose from the valve stem. Make sure the valve stem is free of debris. Reconnect the Sealant Hose to the valve stem. Check that the Mode Select Knob is in the Sealant Mode position and not Air Mode. Push the Power Button to turn on the Tire Service Kit.
2. Connect the Power Plug to a different 12 Volt power outlet in your vehicle or another vehicle, if available. Make sure the engine is running before turning on the Tire Service Kit.
3. The Sealant Bottle may be empty due to previous use. Call for assistance.

NOTE:

If the Mode Select Knob is on Air Mode and the pump is operating, air will dispense from the Air Pump Hose only, not the Sealant Hose.

If the sealant (white fluid) does flow through the Sealant Hose (3):

1. Continue to operate the pump until sealant is no longer flowing through the hose (typically takes 30 - 70 seconds). As the sealant flows through the Sealant Hose, the Pressure Gauge can read as high as 70 psi (4.8 Bar). The Pressure Gauge will decrease quickly from approximately 70 psi (4.8 Bar) to the actual tire pressure when the Sealant Bottle is empty.
2. The pump will start to inject air into the tire immediately after the Sealant Bottle is empty. Continue to operate the pump and inflate the tire to the pres-

sure indicated on the tire pressure label on the driver-side latch pillar (recommended pressure). Check the tire pressure by looking at the Pressure Gauge.

If the tire does not inflate to at least 26 psi (1.8 Bar) pressure within 15 minutes:

- The tire is too badly damaged. Do not attempt to drive the vehicle further. Call for assistance.

NOTE:

If the tire becomes overinflated, push the Deflation Button to reduce the tire pressure to the recommended inflation pressure before continuing.

If the tire inflates to the recommended pressure or is at least 26 psi (1.8 Bar) pressure within 15 minutes:

1. Push the Power Button to turn off the Tire Service Kit.
2. Remove the Speed Limit sticker from the top of the Sealant Bottle and place the sticker on the instrument panel.
3. Immediately disconnect the Sealant Hose from the valve stem, reinstall the cap on the fitting at the end of the hose, and place the Tire Service Kit in the vehicle storage location.

CAUTION!

- The metal end fitting from Power Plug may get hot after use, so it should be handled carefully.
- Failure to reinstall the cap on the fitting at the end of the Sealant Hose can result in sealant contacting your skin, clothing, and the vehicle's interior. It

(Continued)

CAUTION!

can also result in sealant contacting internal Tire Service Kit components which may cause permanent damage to the kit.

(D) Drive Vehicle:

Immediately after injecting sealant and inflating the tire, drive the vehicle 5 miles (8 km) or 10 minutes to ensure distribution of the Tire Service Kit Sealant within the tire. Do not exceed 50 mph (80 km/h).

WARNING!

Tire Service Kit is not a permanent flat tire repair. Have the tire inspected and repaired or replaced after using Tire Service Kit. Do not exceed 50 mph (80 km/h) until the tire is repaired or replaced. Failure to follow this warning can result in injuries that are serious or fatal to you, your passengers, and others around you.

(E) After Driving:

Pull over to a safe location ↪ page 200.

1. Push in the Mode Select Knob and turn to the Air Mode position.
2. Uncoil the power plug and insert the plug into the vehicle's 12 Volt power outlet.
3. Uncoil the Air Pump Hose (black in color) and screw the fitting at the end of hose onto the valve stem.
4. Check the pressure in the tire by reading the Pressure Gauge.

If tire pressure is less than 19 psi (1.3 Bar):

The tire is too badly damaged. Do not attempt to drive the vehicle further. Call for assistance.

If the tire pressure is 19 psi (1.3 Bar) or higher:

1. Push the Power Button to turn on Tire Service Kit and inflate the tire to the pressure indicated on the tire and loading information label on the driver-side door opening.

NOTE:

If the tire becomes overinflated, push the Deflation Button to reduce the tire pressure to the recommended inflation pressure before continuing.

2. Disconnect the Tire Service Kit from the valve stem, reinstall the cap on the valve stem and unplug from 12 Volt outlet.
3. Place the Tire Service Kit in its proper storage area in the vehicle.
4. Have the tire inspected and repaired or replaced at the earliest opportunity at an authorized dealer or tire service center.
5. Remove the Speed Limit sticker from the instrument panel after the tire has been repaired.
6. Replace the Sealant Bottle and Sealant Hose assembly at an authorized dealer as soon as possible ↪ page 202.

NOTE:

When having the tire serviced, advise the authorized dealer or service center that the tire has been sealed using the Tire Service Kit.

(F) Sealant Bottle And Hose Replacement:

1. Replace the Tire Service Kit Sealant Bottle and Sealant Hose prior to the expiration date (printed at the upper right hand corner on the bottle label) to assure optimum operation of the system
↪ page 202.



Tire Service Kit Sealant Expiration Date Location

2. Uncoil the Sealant Hose (clear in color).
3. Locate the red colored round Sealant Bottle release button at the lower right hand corner of the kit.
4. Push and hold the Sealant Bottle release button, then pull out the bottle holding the button.
5. Clean any remaining sealant from the Tire Service Kit housing.
6. Position the new Sealant Bottle in the housing so that the Sealant Hose aligns with the hose slot in the front of the housing. Push and hold the Sealant

Bottle release button, then push the bottle into the housing by holding the button. An audible click will be heard indicating the bottle is locked into place. Release the button.

- Verify that the cap is installed on the fitting at the end of the Sealant Hose and return the hose to its storage area (located on top of the housing).
- Return the Tire Service Kit to its storage location in the vehicle.

JUMP STARTING — GAS MODELS

If your vehicle has a discharged battery, it can be jump started using a set of jumper cables and a battery in another vehicle or by using a portable battery booster pack. Jump starting can be dangerous if done improperly, so please follow the procedures in this section carefully.

NOTE:

When using a portable battery booster pack, follow the manufacturer's operating instructions and precautions.

WARNING!

Do not attempt jump starting if the battery is frozen. It could rupture or explode and cause personal injury.

CAUTION!

Do not use a portable battery booster pack or any other booster source with a system voltage greater than 12 Volts or damage to the battery, starter motor, alternator or electrical system may occur.

PREPARATIONS FOR JUMP START — GAS MODELS

The vehicle's jump starting remote posts are located under the hood, in the engine compartment on the driver's side.

The Remote positive (+) Post is covered with a protective cap located on the side of the Front Power Distribution Center.

The Remote negative (-) Post is located on the core support closest to the front of the vehicle.

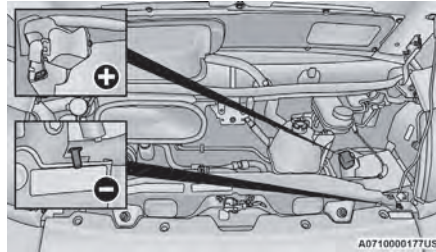

Jump Starting Locations

Remote Positive (+) Post
Remote Negative (-) Post

See the following steps to prepare for jump starting:

- Apply the parking brake, shift the automatic transmission into PARK (P) and turn the ignition to the OFF position.
- Turn off the heater, radio, and all electrical accessories.

- Pull upward and remove the protective cover over the remote positive (+) battery post.
- If using another vehicle to jump start the battery, park the vehicle within the reach of the jumper cables, apply the parking brake and make sure the ignition is OFF.

WARNING!

- Do not allow vehicles to touch each other as this could establish a ground connection and personal injury could result.
- Take care to avoid the radiator cooling fan whenever the hood is raised. It can start anytime the ignition switch is ON. You can be injured by moving fan blades.
- Remove any metal jewelry such as rings, watch bands and bracelets that could make an inadvertent electrical contact. You could be seriously injured.
- Batteries contain sulfuric acid that can burn your skin or eyes and generate hydrogen gas which is flammable and explosive. Keep open flames or sparks away from the battery.

7

JUMP STARTING PROCEDURE — GAS MODELS

WARNING!

Failure to follow this jump starting procedure could result in personal injury or property damage due to battery explosion.

CAUTION!

Failure to follow these procedures could result in damage to the charging system of the booster vehicle or the discharged vehicle.

Connecting The Jumper Cables

1. Connect the positive (+) end of the jumper cable to the remote positive (+) post of the discharged vehicle.

NOTE:

The remote positive (+) post is located in the engine compartment on the driver's side under the cover of the Front Power Distribution Center.

2. Connect the opposite end of the positive (+) jumper cable to the positive (+) post of the booster battery.
3. Connect the negative (-) end of the jumper cable to the negative (-) post of the booster battery.
4. Connect the opposite end of the negative (-) jumper cable to the remote negative post or a good engine ground of the discharged vehicle. A "ground" is an exposed metallic/unpainted part of the engine, frame or chassis, such as an accessory bracket or large bolt. The ground must be away from the battery and the fuel injection system.

NOTE:

The remote negative (-) post is located in the front of the engine compartment on the driver's side.

WARNING!

Do not connect the jumper cable to the negative (-) post of the discharged battery. The resulting electrical spark could cause the battery to explode and could result in personal injury.

5. Start the engine in the vehicle that has the booster battery. Let the engine idle a few minutes and then start the engine in the vehicle with the discharged battery.
6. Once the engine is started, follow the disconnecting procedure.

Disconnecting The Jumper Cables

1. Disconnect the negative (-) end of the jumper cable from the remote negative (-) post of the vehicle with the discharged battery.
2. Disconnect the opposite end of the negative (-) jumper cable from the negative (-) post of the booster battery.
3. Disconnect the positive (+) end of the jumper cable from the positive (+) post of the booster battery.
4. Disconnect the opposite end of the positive (+) jumper cable from the remote positive (+) post of the discharged vehicle, and reinstall the protective cap.
5. Close the cover of the Front Power Distribution Center.

If frequent jump starting is required to start your vehicle you should have the battery and charging system inspected at an authorized dealer.

CAUTION!

Accessories plugged into the vehicle power outlets draw power from the vehicle's battery, even when not in use (i.e., cellular devices, etc.). Eventually, if plugged in long enough without engine operation, the vehicle's battery will discharge sufficiently to degrade battery life and/or prevent the engine from starting.

BATTERY LOCATION

There are two remote jump starting posts under the hood which is the recommended jump start location. If access to the battery is needed, an access panel on the driver's side floor will allow for battery access.

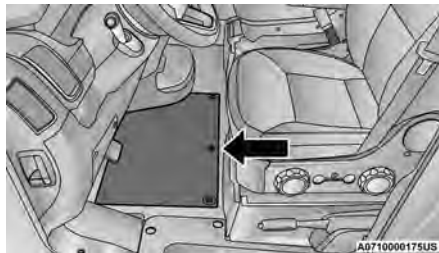
**Battery Access Panel**

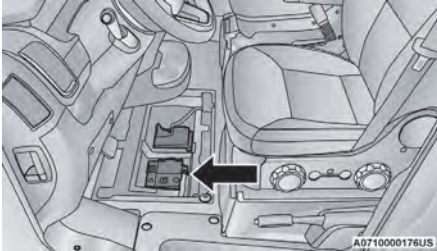

Battery Location

JUMP STARTING — BEV MODELS

If your vehicle has a discharged battery, it can be jump started using a set of jumper cables and a battery in another vehicle or by using a portable battery booster pack. Jump starting can be dangerous if done improperly, so please follow the procedures in this section carefully.

NOTE:

When using a portable battery booster pack, follow the manufacturer's operating instructions and precautions. The vehicle requires its 12 Volt battery power to turn-on the vehicle's high voltage battery. The high voltage battery is used to charge the 12 Volt battery, provide electric vehicle operation. If the 12 Volt battery has been discharged, the vehicle can be jump started using a set of jumper cables and a battery in another vehicle or by using a portable battery booster pack.

If the vehicle's high voltage battery has also been discharged, it will need to be recharged to a minimum operating State Of Charge (SOC) before the vehicle can be operated:

- If the vehicle can be connected to a Level 1 or Level 2 charger where it is currently parked, the vehicle will still require a jump start to allow the vehicle to begin the battery charging process. Once the vehicle charging has begun (indicated by the charge status indicator on top of the vehicle's instrument panel), the jumper cables can be removed from the vehicle jump posts.
- If the vehicle cannot be connected to a Level 1 or Level 2 charger where it is currently parked, the vehicle can be moved by connecting 12 Volt power to the vehicle's jump posts and then shifting the transmission from PARK (P) into NEUTRAL (N). Power provided by the jumper cables will also allow the Electric Park Brake to be released. Carefully move the vehicle to a Level 1 or Level 2 charge location. While the vehicle is being moved, the external 12 Volt power must remain connected to the vehicle jump posts.

NOTE:

Be careful when moving the vehicle - ensure that control of the vehicle is maintained. Also, ensure that vehicle is secured to prevent unintentional movement during and after moving the vehicle. If the external 12 Volt power becomes disconnected from the vehicle jump posts or there is an interruption of the 12 Volt power while moving the vehicle, the vehicle's transmission may engage PARK. Do not allow the jumper cables to come in contact with each other or to the vehicle, this will result in a short.

When the vehicle is at the charging location, shift the transmission back to PARK, apply the Electric Park Brake, and start the high voltage battery charging. Once the vehicle has been secured against unintentional movement and high voltage battery charging has been initiated, the jumper cables can be removed from the vehicle jump posts.

WARNING!

Do not attempt jump starting if the battery is frozen. It could rupture or explode and cause personal injury.

CAUTION!

Do not use a portable battery booster pack or any other booster source with a system voltage greater than 12 Volts or damage to the battery, starter motor, alternator or electrical system may occur.

PREPARATIONS FOR JUMP START — BEV MODELS

The vehicle's jump starting remote posts are located under the hood, on the driver's side.

The remote positive (+) post is covered with a protective cap located on the side of the Fuse And Relay Box.

The remote negative (-) post is located near the center of the windshield cowl.

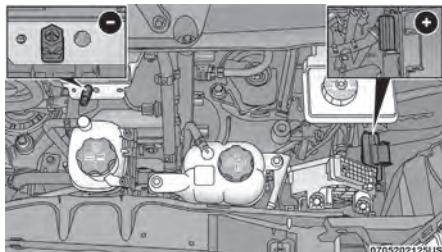

Jump Starting Locations

Remote Positive (+) Post
Remote Negative (-) Post

See the following steps to prepare for jump starting:

1. Apply the parking brake, shift the automatic transmission into PARK (P) and turn the ignition to the OFF position.
2. Turn off the heater, radio, and all electrical accessories.
3. Pull upward and remove the protective cover over the remote positive (+) battery post.
4. If using another vehicle to jump start the 12 Volt electrical system, park the vehicle within the reach of the jumper cables, apply the parking brake and make sure the ignition is OFF.

WARNING!

- Do not allow vehicles to touch each other as this could establish a ground connection and personal injury could result.
- Take care to avoid the radiator cooling fan whenever the hood is raised. It can start anytime the ignition switch is ON. You can be injured by moving fan blades.
- Remove any metal jewelry such as rings, watch bands and bracelets that could make an inadvertent electrical contact. You could be seriously injured.
- Batteries contain sulfuric acid that can burn your skin or eyes and generate hydrogen gas which is flammable and explosive. Keep open flames or sparks away from the battery.

JUMP STARTING PROCEDURE — BEV MODELS

WARNING!

Failure to follow this jump starting procedure could result in personal injury or property damage due to battery explosion.

CAUTION!

Failure to follow these procedures could result in damage to the charging system of the booster vehicle or the discharged vehicle.

Connecting The Jumper Cables

1. Connect the positive (+) end of the jumper cable to the remote positive (+) post of the discharged vehicle.

NOTE:

The remote positive (+) post is located in the engine compartment on the driver's side under the cover of the Fuse And Relay Box.

2. Connect the opposite end of the positive (+) jumper cable to the positive (+) post of the booster battery.
3. Connect the negative (-) end of the jumper cable to the negative (-) post of the booster battery.
4. Connect the opposite end of the negative (-) jumper cable to the remote negative post or a good ground of the discharged vehicle. A "ground" is an exposed metallic/unpainted part of the engine, frame or chassis, such as an accessory bracket or large bolt. The ground must be away from the battery and the fuel injection system.

NOTE:

The remote negative (-) post is located in the front of the engine compartment on the driver's side.

WARNING!

Do not connect the jumper cable to the negative (-) post of the discharged battery. The resulting electrical spark could cause the battery to explode and could result in personal injury.

- Start the engine in the vehicle that has the booster battery, let the engine idle a few minutes and then cycle the ignition to ON/RUN in the vehicle with the discharged battery.
- After a couple minutes (depending on the level of 12 Volt battery discharge), attempt to start the vehicle. Once the vehicle starts, follow the disconnecting procedure.

Disconnecting The Jumper Cables

- Disconnect the negative (-) end of the jumper cable from the remote negative (-) post of the vehicle with the discharged battery.
- Disconnect the opposite end of the negative (-) jumper cable from the negative (-) post of the booster battery.
- Disconnect the positive (+) end of the jumper cable from the positive (+) post of the booster battery.
- Disconnect the opposite end of the positive (+) jumper cable from the remote positive (+) post of the discharged vehicle, and reinstall the protective cap.
- Close the cover of the Front Power Distribution Center.

If frequent jump starting is required to start your vehicle you should have the battery and charging system inspected at an authorized dealer.

CAUTION!

Accessories plugged into the vehicle power outlets draw power from the vehicle's battery, even when not in use (i.e., cellular devices, etc.). Eventually, if plugged in long enough without engine operation, the vehicle's battery will discharge sufficiently to degrade battery life and/or prevent the engine from starting.

BATTERY LOCATION

There are two remote jump starting posts under the hood which is the recommended jump start location. If access to the battery is needed, an access panel on the driver's side floor will allow for battery access.

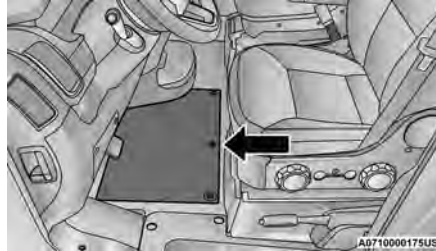

Battery Access Panel

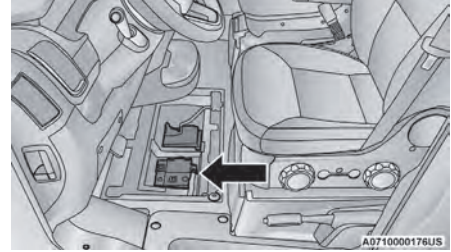

Battery Location

IF YOUR ENGINE OVERHEATS

If the vehicle is overheating, it will need to be serviced by an authorized dealer.

In any of the following situations, you can reduce the potential for overheating by taking the appropriate action.

- On the highways — slow down.
- In city traffic — while stopped, place the transmission in NEUTRAL (N), but do not increase the engine idle speed while preventing vehicle motion with the brakes.

NOTE:

There are steps that you can take to slow down an impending overheating condition:

- If your Air Conditioner (A/C) is on, turn it off. The A/C system adds heat to the engine cooling system and turning the A/C off can help remove this heat.

- You can also turn the temperature control to maximum heat, the mode control to floor and the blower control to high. This allows the heater core to act as a supplement to the radiator and aids in removing heat from the engine cooling system.

WARNING!

You or others can be badly burned by hot engine coolant (antifreeze) or steam from your radiator. If you see or hear steam coming from under the hood, do not open the hood until the radiator has had time to cool. Never try to open a cooling system pressure cap when the radiator or coolant bottle is hot.

CAUTION!

Driving with a hot cooling system could damage your vehicle. If the temperature gauge reads HOT (H), pull over and stop the vehicle. Idle the vehicle with the air conditioner turned off until the pointer drops back into the normal range. If the pointer remains on HOT (H), and you hear continuous chimes, turn the engine off immediately and call for service.

GEAR SELECTOR OVERRIDE

If a malfunction occurs and the gear selector cannot be moved out of the PARK (P) position, you can use the following procedure to temporarily move the gear selector:

1. Turn the engine OFF.
2. Firmly apply the parking brake.
3. Using a small screwdriver or similar tool, remove the shifter boot material of the gear selector by pulling up to carefully separate the gear selector bezel and boot assembly from the console.

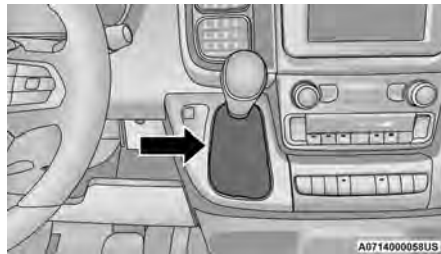
**Shifter Boot And Bezel**

4. Press and maintain firm pressure on the brake pedal.
5. Insert the screwdriver or similar tool into the gear selector override release and push down while depressing the shifter button at the same time.

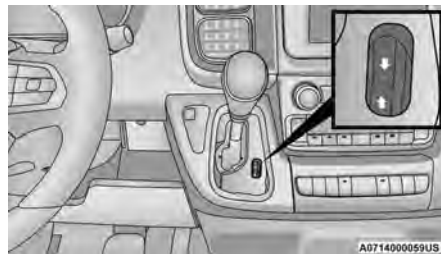
**Gear Selector Override Release Lever**

6. Move the gear selector to the NEUTRAL (N) position.
7. The vehicle may then be started in NEUTRAL.
8. Reinstall the shifter boot and bezel.

FREING A STUCK VEHICLE

If your vehicle becomes stuck in mud, sand, or snow, it can often be moved using a rocking motion. Turn the steering wheel right and left to clear the area around the front wheels. Shift back and forth between DRIVE (D) and REVERSE (R), while gently pressing the accelerator. Use the least amount of accelerator pedal pressure that will maintain the rocking motion, without spinning the wheels or racing the engine.

CAUTION!

Racing the engine or spinning the wheels may lead to transmission overheating and failure. Allow the engine to idle with the transmission in NEUTRAL for at least one minute after every five rocking-motion cycles. This will minimize overheating and reduce the risk of transmission failure during prolonged efforts to free a stuck vehicle.

WARNING!

Fast spinning tires can be dangerous. Forces generated by excessive wheel speeds may cause damage, or even failure, of the axle and tires. A tire could explode and injure someone. Do not spin your vehicle's wheels faster than 30 mph (48 km/h) or for longer than 30 seconds continuously without stopping when you are stuck and do not let anyone near a spinning wheel, no matter what the speed.

CAUTION!

- When "rocking" a stuck vehicle by shifting between DRIVE and REVERSE, do not spin the wheels faster than 15 mph (24 km/h), or drivetrain damage may result.
- Spinning the wheels too fast may lead to transmission overheating and failure. It can also damage the tires. Do not spin the wheels above 30 mph (48 km/h) while in gear (no transmission shifting occurring).

NOTE:

Push the ESC OFF button, to place the Electronic Stability Control System (ESC) in "Partial OFF" mode, before rocking the vehicle → page 153. Once the vehicle has been freed, push the ESC OFF button again to restore "ESC ON" mode.

TOWING A DISABLED VEHICLE

This section describes procedures for towing a disabled vehicle using a commercial towing service.

Towing Condition	Wheels OFF the Ground	Automatic Transmission
Flat Tow	NONE	NOT ALLOWED
Dolly Tow	Front	OK
	Rear	NOT ALLOWED
On Trailer	ALL	OK

NOTE:

When towing your vehicle, always follow applicable state and provincial laws. Contact state and provincial Highway Safety offices for additional details.

Proper towing or lifting equipment is required to prevent damage to your vehicle. Use only tow bars and other equipment designed for this purpose, following equipment manufacturer's instructions. Use of safety chains is mandatory. Attach a tow bar or other towing device to main structural members of the vehicle, not to fascia/bumper or associated brackets. State and local laws regarding vehicles under tow must be observed.

NOTE:

- You must ensure that the Auto Park Brake  page 89 feature is disabled before towing this vehicle to avoid inadvertent Electric Park Brake engagement. The Auto Park Brake feature is enabled or disabled via the customer programmable features in the Uconnect Settings.
- Vehicles with a discharged battery, or total electrical failure when the Electric Park Brake (EPB) is engaged, will need a wheel dolly or jack to raise the rear wheels off the ground when moving the vehicle onto a flatbed.
- The Safehold feature will engage the Electric Park Brake whenever the driver's door is opened (if the battery is connected, ignition is ON, transmission is not in PARK, and brake pedal is released). If you are towing this vehicle with the ignition in the ON/RUN mode, you must manually disable the Electric Park Brake each time the driver's door is opened by pressing the brake pedal and then releasing the EPB.

If you must use the accessories (wipers, defrosters, etc.) while being towed, the ignition must be in the ON/RUN mode.

If the key fob is unavailable or the vehicle's battery is discharged, for instructions on shifting the automatic transmission out of PARK (P) for towing  page 208.

CAUTION!

- Do not use sling type equipment when towing. Vehicle damage may occur.
- When securing the vehicle to a flat bed truck, do not attach to front or rear suspension components. Damage to your vehicle may result from improper towing.

AUTOMATIC TRANSMISSION

The FCA US LLC recommends towing your vehicle with all four wheels **OFF** the ground using a flatbed.

If flatbed equipment is not available, and the transmission is operable, this vehicle may be towed (with front wheels on the ground) under the following conditions:

- The transmission must be in NEUTRAL (N).
- For gas vehicles, the towing speed must not exceed 25 mph (40 km/h).
- For BEV vehicles, the towing speed must not exceed 5 mph (8 km/h).
- For gas vehicles, the towing distance must not exceed 15 miles (24 km).
- For BEV vehicles, the towing distance must not exceed 65 feet (0.0198 km).

For Gas vehicles, if the transmission is not operable, or the vehicle must be towed faster than 25 mph (40 km/h) or farther than 15 miles (24 km), tow with the front wheels **OFF** the ground (using a flatbed truck, or wheel lift equipment with the front wheels raised).

CAUTION!

- For gas vehicles, towing faster than 25 mph (40 km/h) or farther than 15 miles (24 km) with

(Continued)

CAUTION!

front wheels on the ground can cause severe transmission damage. Damage from improper towing is not covered under the New Vehicle Limited Warranty.

- For BEV vehicles, towing faster than 5 mph (8 km/h) or farther than 65 feet (0.0198 km) with front wheels on the ground can cause severe transmission damage. Damage from improper towing is not covered under the New Vehicle Limited Warranty.
- Towing this vehicle in violation of the approved requirements can cause severe transmission damage. Damage from improper towing is not covered under the New Vehicle Limited Warranty.

Tow Eye Usage — If Equipped

Your vehicle may come equipped with a front tow eye that can be used to move a disabled vehicle.



A071700043US

Tow Eye

When using the tow eye, see the following precautions.

Tow Eye Usage Precautions

CAUTION!

- The tow eye must only be used for roadside emergencies. Use with an appropriate device in accordance with highway code (a rigid bar) to maneuver the vehicle in preparation for transport via a tow truck.
- The tow eye must not be used to move the vehicle off the road or where there are obstacles.
- Do not use the tow eyes for tow truck hookup or highway towing.
- Do not use the tow eye to free a stuck vehicle ↪ page 208.
- Damage to your vehicle may occur if these guidelines are not followed ↪ page 209.



0614050552

Tow Eye Warning Label

WARNING!

Stand clear of vehicles when pulling with tow eyes.

- Do not use a chain with a tow eye. Chains may break, causing serious injury or death.
- Do not use a tow strap with a tow eye. Tow straps may break or become disengaged, causing serious injury or death.
- Failure to follow proper tow eye usage may cause components to break resulting in serious injury or death.
- Before tightening the tow-eye, clean the threaded housing thoroughly. Make sure that the tow-eye is fully fastened in the housing before towing a disabled vehicle.
- For BEV vehicles, NEVER tow a disabled vehicle with two or four wheels on the road. Risk of damaging the motor and fire hazard. It is imperative that the vehicle is towed by a tow truck.
- For BEV vehicles, in the case of a discharged high voltage battery and a discharged 12V battery, NEVER tow the disabled vehicle. Transport it on a tow truck and contact a Ram Dealership.
- For BEV vehicles, it is permitted to tow for short distances at a speed not exceeding 5 mph using a special device conforming to the Highway Code (rigid bar) and ONLY for preparation for transport by tow truck, keeping the disabled vehicle aligned on the same centerline as the tow truck.
- For BEV vehicles, the tow eye MUST NOT be used to tow cars off the road or where there are obstacles and/or for towing operations using cables or other non-rigid devices.

TOW EYE INSTALLATION

The front tow eye receptacle is located behind a door on the passenger's side of the fascia/bumper.

To install the tow eye, open the door using the vehicle key or a small screwdriver. Thread the tow eye into the receptacle, making sure it is fully tightened.

The tow eye must be securely seated to the attaching bracket through the lower front fascia/bumper. If the tow eye is not securely seated to the attaching bracket, the vehicle should not be moved.

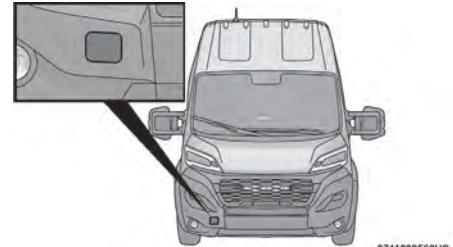

0711202562US

Front Tow Eye Access Door

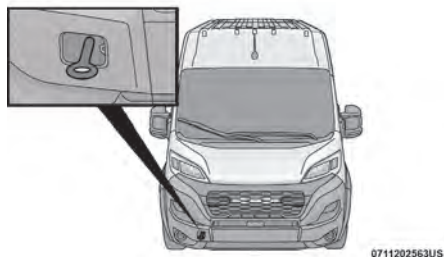

Front Tow Eye Installed

ENHANCED ACCIDENT RESPONSE SYSTEM (EARS)

This vehicle is equipped with an Enhanced Accident Response System.

This feature is a communication network that takes effect in the event of an impact. ↪ page 175

EVENT DATA RECORDER (EDR)

This vehicle is equipped with an event data recorder (EDR). The main purpose of an EDR is to record data that will assist in understanding how a vehicle's systems performed under certain crash or near crash-like situations, such as an air bag deployment or hitting a road obstacle ↪ page 176.

SERVICING AND MAINTENANCE

SCHEDULED SERVICING

Your vehicle is equipped with an automatic oil change indicator system. The oil change indicator system will remind you that it is time to take your vehicle in for scheduled maintenance.

Based on engine operation conditions, the oil change indicator message will illuminate in the instrument cluster. This means that service is required for your vehicle. Operating conditions such as frequent short-trips, trailer tow, and extremely hot or cold ambient temperatures will influence when the "Oil Change Required" message is displayed. Have the vehicle serviced as soon as possible, within the next 500 miles (805 km).

An authorized dealer will reset the oil change indicator message after completing the scheduled oil change. If a scheduled oil change is performed by someone other than an authorized dealer, the message can be reset by referring to the steps described under Instrument Cluster Display ↪ page 71.

NOTE:

Under no circumstances should oil change intervals exceed 10,000 miles (16,000 km), 12 months or 350 hours of engine run time, whichever comes first. The 350 hours of engine run or idle time is generally only a concern for fleet customers.

Once A Month Or Before A Long Trip:

- Check engine oil level
- Check windshield washer fluid level

- Check the tire pressures and look for unusual wear or damage. Rotate at the first sign of irregular wear, even if it occurs before the oil indicator system turns on
- Check the fluid levels of the coolant reservoir, and brake master cylinder and fill as needed
- Check function of all interior and exterior lights

MAINTENANCE PLAN

Refer to the maintenance plan for the required maintenance intervals. More frequent maintenance may be needed in severe conditions, such as dusty areas and very short trip driving. In some extreme conditions, additional maintenance not specified in the maintenance schedule may be required.

At Every Oil Change Interval As Indicated By Oil Change Indicator System

- Change oil and filter.
- Rotate the tires at the first sign of irregular wear, even if it occurs before the oil indicator system turns on.
- Inspect battery and clean and tighten terminals as required.
- Inspect the CV/Universal joints.
- Inspect brake pads, shoes, rotors, drums, hoses and parking brake.
- Inspect engine cooling system protection and hoses.
- Inspect exhaust system.
- Inspect engine air cleaner filter if using in dusty or off-road conditions.
- Inspect and replace the Evaporative System Fresh Air Filter as necessary, replacement may be more frequent if vehicle is operated in extreme dusty conditions.

Mileage Or Time Passed (Whichever Comes First)	20,000	30,000	40,000	50,000	60,000	70,000	80,000	90,000	100,000	110,000	120,000	130,000	140,000	150,000
Or Years:	2	3	4	5	6	7	8	9	10	11	12	13	14	15
Or Kilometers:	32,000	48,000	64,000	80,000	96,000	112,000	128,000	144,000	160,000	176,000	192,000	208,000	224,000	240,000
Additional Inspections														
Inspect the CV/Universal joints.	X	X	X	X	X	X	X	X	X	X	X	X	X	X
Inspect front suspension, tie rod ends, boot seals, and replace if necessary.	X		X		X		X		X		X		X	
Inspect the brake pads, replace as necessary.	X		X		X		X		X		X		X	
Inspect the rear door net block gap, adjust/replace as necessary.		X			X			X			X			X
Additional Maintenance														
Replace the engine air cleaner filter.		X			X			X			X			X
Inspect the cabin air filter, replace as necessary.	X		X		X		X		X		X		X	
Replace the Brake Fluid every two years. *	X		X		X		X		X		X		X	
Replace the spark plugs. **									X					
Flush and replace the engine coolant at 10 years or 150,000 miles (240,000 km) whichever comes first.									X					X
Inspect and replace the PCV valve if necessary.									X					

* The brake fluid change interval is time based only, mileage intervals do not apply.

** The spark plug change interval is mileage based only, yearly intervals do not apply.

WARNING!

- You can be badly injured working on or around a motor vehicle. Do only service work for which you have the knowledge and the right equipment. If you have any doubt about your ability to perform a service job, take your vehicle to a competent mechanic.
- Failure to properly inspect and maintain your vehicle could result in a component malfunction and affect vehicle handling and performance. This could cause an accident.

ENGINE COMPARTMENT

3.6L ENGINE

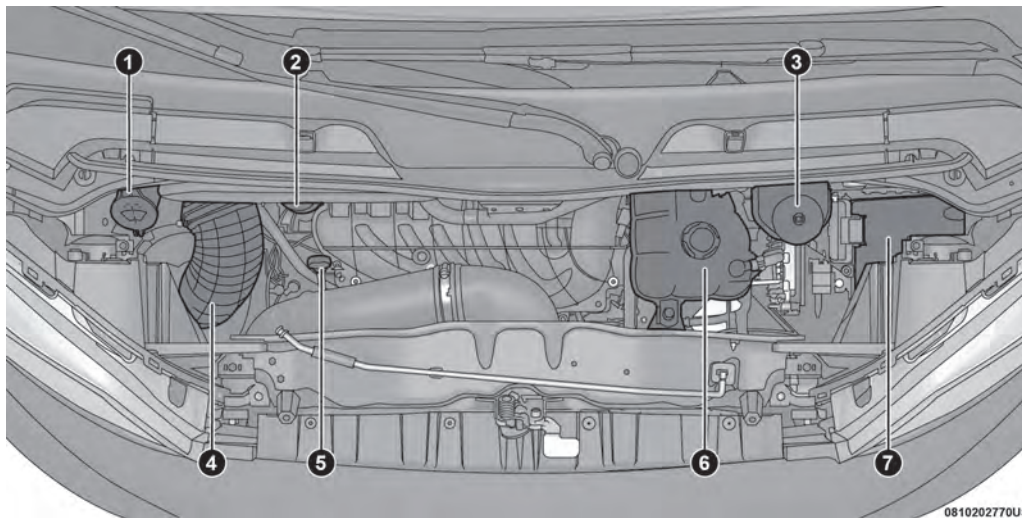

0810202770US

- 1 – Washer Fluid Reservoir Cap
- 2 – Engine Oil Fill
- 3 – Brake Fluid Reservoir Cap
- 4 – Engine Air Cleaner, Filter

- 5 – Engine Oil Dipstick
- 6 – Coolant Reservoir Cap
- 7 – Power Distribution Center (Fuses)

CHECKING OIL LEVEL

WARNING!

- Never smoke while working in the engine compartment: gas and flammable vapors may be present, with the risk of fire.
- Be very careful when working in the engine compartment when the engine is hot: you may get burned. Do not get too close to the radiator cooling fan: the electric fan may start; danger of injury. Scarves, ties and other loose clothing might be pulled by moving parts.

CAUTION!

- Be careful not to confuse the various types of fluids while topping up: they are not compatible with each other! Topping up with an unsuitable fluid could severely damage your car.
- The oil level must never exceed the MAX mark.
- Always top up using engine oil of the same specifications as that already in the engine.
- If the engine oil is being topped up, wait for the engine to cool down before loosening the filler cap, particularly for vehicles with aluminum caps (if equipped). WARNING: risk of burns!
- Overfilling or underfilling the crankcase will cause aeration or loss of oil pressure. This could damage your engine.

To ensure proper engine lubrication, the engine oil must be maintained at the correct level. Check the oil level at regular intervals, such as every fuel stop. The best time to check the engine oil level is about five minutes after a fully warmed up engine is shut off.

Checking the oil while the vehicle is on level ground will improve the accuracy of the oil level readings.

There are four possible dipstick types:

- Crosshatched zone.
- Crosshatched zone marked SAFE.
- Crosshatched zone marked with MIN at the low end of the range and MAX at the high end of the range.
- Crosshatched zone marked with dimples at the MIN and the MAX ends of the range.

NOTE:

Always maintain the oil level within the crosshatch markings on the dipstick.

Adding 1 qt (1 L) of oil when the reading is at the low end of the dipstick range will raise the oil level to the high end of the range marking.

CAUTION!

Overfilling or underfilling the crankcase will cause aeration or loss of oil pressure. This could damage your engine.

ADDING WASHER FLUID

The fluid reservoir is located in the engine compartment and should be checked at regular intervals. Fill the reservoir with windshield washer solvent (not radiator antifreeze) and operate the system for a few seconds to flush out any residual water.

The washer fluid reservoir will hold a full gallon of fluid when the Low Washer Fluid Light illuminates.

WARNING!

Commercially available windshield washer solvents are flammable. They could ignite and burn you. Care must be exercised when filling or working around the washer solution.

After the engine has warmed, operate the defroster for a few minutes to reduce the possibility of smearing or freezing the fluid on the cold windshield. Mopar® All Weather Windshield Washer Solution or equivalent, used with water as directed on the container, aids cleaning action, reduces the freezing point to avoid line clogging, and is not harmful to paint or trim.

MAINTENANCE-FREE BATTERY

Your vehicle is equipped with a maintenance-free battery. You will never have to add water, and periodic maintenance is not required.

WARNING!

- Battery fluid is a corrosive acid solution and can burn or even blind you. Do not allow battery fluid to contact your eyes, skin, or clothing. Do not lean over a battery when attaching clamps. If acid splashes in eyes or on skin, flush the area immediately with large amounts of water → page 203.
- Battery gas is flammable and explosive. Keep flame or sparks away from the battery. Do not use a booster battery or any other booster source with an output greater than 12 Volts. Do not allow cable clamps to touch each other.

(Continued)

WARNING!

- Battery posts, terminals, and related accessories contain lead and lead compounds. Wash hands after handling.

CAUTION!

- It is essential when replacing the cables on the battery that the positive cable is attached to the positive post and the negative cable is attached to the negative post. Battery posts are marked positive (+) and negative (-) and are identified on the battery case. Cable clamps should be tight on the terminal posts and free of corrosion.
- If a "fast charger" is used while the battery is in the vehicle, disconnect both vehicle battery cables before connecting the charger to the battery. Do not use a "fast charger" to provide starting voltage.

PRESSURE WASHING

Cleaning the engine compartment with a high pressure washer is not recommended.

CAUTION!

Precautions have been taken to safeguard all parts and connections however, the pressures generated by these machines is such that complete protection against water ingress cannot be guaranteed.

Engine Compartment — BEV (if equipped)

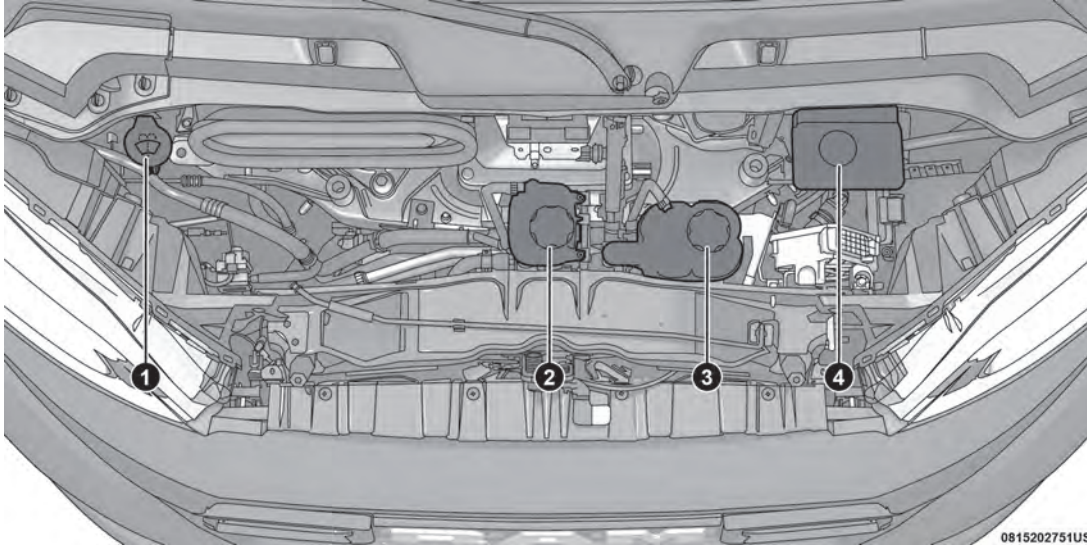

1 — Washer Fluid Reservoir Cap
2 — Secondary Coolant Reservoir Cap

3 — Primary Coolant Reservoir Cap
4 — Brake Fluid Reservoir Cap

0815202751US

VEHICLE MAINTENANCE

An authorized dealer has the qualified service personnel, special tools, and equipment to perform all service operations in an expert manner. Service Manuals are available which include detailed service information for your vehicle. Refer to these Service Manuals before attempting any procedure yourself.

NOTE:

Intentional tampering with emissions control systems may void your warranty and could result in civil penalties being assessed against you.

WARNING!

You can be badly injured working on or around a motor vehicle. Only do service work for which you have the knowledge and the proper equipment. If you have any doubt about your ability to perform a service job, take your vehicle to a competent mechanic.

ENGINE OIL

Engine Oil Selection

Use only the manufacturer's recommended fluids
 ⇨ page 265.

American Petroleum Institute (API) Approved Engine Oil

These symbols mean that the oil has been certified by the API. The manufacturer only recommends API trademark oils.



The API Starburst trademark certifies 0W-20, 0W-30 and 5W-30 engine oils.



The API Donut trademark certifies 0W-40 and 5W-40 engine oil.

CAUTION!

Do not use chemical flushes in your engine oil as the chemicals can damage your engine. Such damage is not covered by the New Vehicle Limited Warranty.

Synthetic Engine Oils

Your engine was designed for synthetic engine oils, only use synthetic API approved engine oils.

Synthetic engine oils which do not have both the engine oil certification mark and the correct SAE viscosity grade number should not be used.

Materials Added To Engine Oil

The manufacturer strongly recommends against the addition of any additives (other than leak detection dyes) to the engine oil. Engine oil is an engineered product and its performance may be impaired by supplemental additives.

Disposing Of Used Engine Oil And Oil Filters

Care should be taken in disposing of used engine oil and oil filters from your vehicle. Used oil and oil filters, indiscriminately discarded, can present a problem to

the environment. Contact an authorized dealer, service station or governmental agency for advice on how and where used oil and oil filters can be safely discarded in your area.

ENGINE OIL FILTER

The engine oil filter should be replaced with a new filter at every engine oil change.

Engine Oil Filter Selection

A full-flow type disposable oil filter should be used for replacement. The quality of replacement filters varies considerably. Only high quality Mopar® certified filters should be used. If Mopar® Engine Oil Filters are unavailable, only use filters that meet or exceed SAE/USCAR-36 Filter Performance Requirements.

ENGINE AIR CLEANER, FILTER

For the proper maintenance intervals ⇨ page 213.

NOTE:

Be sure to follow the "Severe Duty Conditions" maintenance interval if applicable.

WARNING!

The air induction system (air cleaner, hoses, etc.) can provide a measure of protection in the case of engine backfire. Do not remove the air induction system (air cleaner, hoses, etc.) unless such removal is necessary for repair or maintenance. Make sure that no one is near the engine compartment before starting the vehicle with the air induction system (air cleaner, hoses, etc.) removed. Failure to do so can result in serious personal injury.

Engine Air Cleaner, Filter Selection

The quality of replacement filters varies considerably. Only high quality Mopar® certified filters should be used.

Engine Air Cleaner, Filter Inspection and Replacement

Engine Air Cleaner, Filter Removal

1. With a suitable tool, loosen the clamps and remove the engine air duct supply hose.



Engine Air Duct Supply Hose

- 1 – Clamps
- 2 – Engine Air Duct Supply Hose

2. With a suitable tool, fully loosen fasteners on the engine air cleaner filter cover and remove the cover.

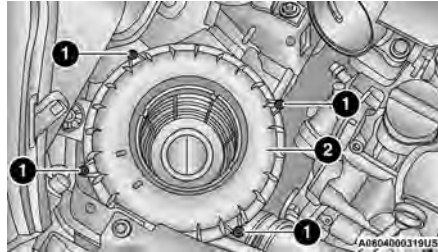

Engine Air Cleaner, Filter Cover

- 1 – Fasteners
- 2 – Engine Air Cleaner, Filter Cover

3. Remove engine air filter from the housing assembly.

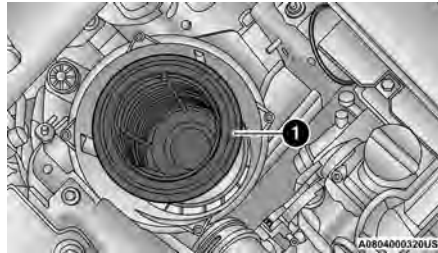

Engine Air Cleaner, Filter

- 1 – Engine Air Filter

Engine Air Cleaner, Filter Installation

NOTE:

Inspect and clean the housing assembly if significant dirt or debris is present before replacing the engine air cleaner filter.

1. Install the engine air cleaner, filter into the housing assembly.
2. Install the engine air cleaner, filter cover onto the housing assembly.
3. Tighten the fasteners on the engine air cleaner, filter assembly.
4. Install the engine air duct supply hose and tighten the clamps

AIR CONDITIONER MAINTENANCE

For best possible performance, your air conditioner should be checked and serviced by an authorized dealer at the start of each warm season. This service should include cleaning of the condenser fins and a performance test. Drive belt tension should also be checked at this time.

WARNING!

- Use only refrigerants and compressor lubricants approved by the manufacturer for your air conditioning system. Some unapproved refrigerants are flammable and can explode, injuring you. Other unapproved refrigerants or lubricants can cause the system to fail, requiring costly repairs. Refer to Warranty Information Book, for further warranty information.

(Continued)

WARNING!

- The air conditioning system contains refrigerant under high pressure. To avoid risk of personal injury or damage to the system, adding refrigerant or any repair requiring lines to be disconnected should be done by an experienced technician.

CAUTION!

Do not use chemical flushes in your air conditioning system as the chemicals can damage your air conditioning components. Such damage is not covered by the New Vehicle Limited Warranty.

Refrigerant Recovery And Recycling

R-134a Air Conditioning Refrigerant is a Hydrofluorocarbon (HFC) that is an ozone-saving product. However, the manufacturer recommends that air conditioning service be performed by authorized dealer or other service facilities using recovery and recycling equipment.

NOTE:

Use only the manufacturer approved A/C system PAG compressor oil and refrigerants.

Cabin Air Filter

Refer to the Maintenance Plan in this chapter for the proper maintenance intervals ↩ page 213.

WARNING!

Do not remove the cabin air filter while the vehicle is running, or while the ignition is in the ACC or ON/RUN position. With the cabin air filter removed and the

(Continued)

WARNING!

blower operating, the blower can contact hands and may propel dirt and debris into your eyes, resulting in personal injury.

The cabin air filter is located in the fresh air inlet in the engine compartment. Perform the following procedure to replace the filter:

1. Remove the two screws that secure the filter retainer to the fresh air inlet, and remove the filter retainer.

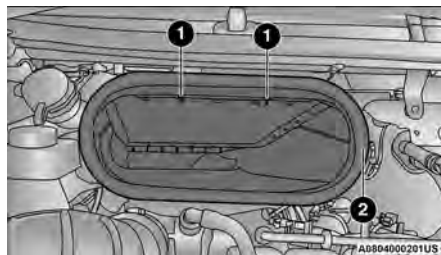

Accessing Air Filter

- 1 — Screw Locations
- 2 — Fresh Air Inlet

2. Remove and replace the cabin air filter from the filter retainer.

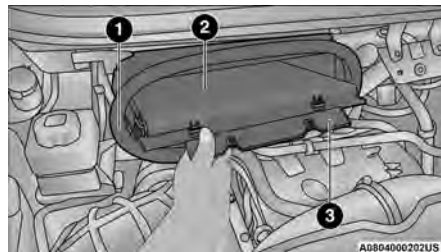

Removing Air Filter

- 1 — Fresh Air Inlet
- 2 — Cabin Air Filter
- 3 — Cabin Air Filter Retainer

3. Install the cabin air filter/filter retainer back into the fresh air inlet. When installing the filter retainer make sure the retainer is fully engaged.
4. Install the two screws back into the assembly to secure the filter retainer to the fresh air inlet.

BODY LUBRICATION

Locks and all body pivot points, including such items as seat tracks, door hinge pivot points and rollers, liftgate, tailgate, decklid, sliding doors and hood hinges, should be lubricated periodically with a lithium-based grease, such as Mopar® Spray White Lube to ensure quiet, easy operation and to protect against rust and wear. Prior to the application of any lubricant, the parts concerned should be wiped clean to remove dust and grit; after lubricating, excess oil and grease should be removed. Particular attention should also be given to

hood latching components to ensure proper function. When performing other underhood services, the hood latch release mechanism, and safety catch should be cleaned and lubricated.

The external lock cylinders should be lubricated twice a year, preferably in the Autumn and Spring. Apply a small amount of a high quality lubricant, such as Mopar® Lock Cylinder Lubricant directly into the lock cylinder.

WINDSHIELD WIPER BLADES

Clean the rubber edges of the wiper blades and the windshield periodically with a sponge or soft cloth and a mild nonabrasive cleaner. This will remove accumulations of salt or road film.

Operation of the wipers on dry glass for long periods may cause deterioration of the wiper blades. Always use washer fluid when using the wipers to remove salt or dirt from a dry windshield.

Avoid using the wiper blades to remove frost or ice from the windshield. Keep the blade rubber out of contact with petroleum products such as engine oil, gasoline, etc.

NOTE:

Life expectancy of wiper blades varies depending on geographical area and frequency of use. If chattering, marks, water lines or wet spots are present, clean the wiper blades or replace as necessary.

EXHAUST SYSTEM

The best protection against carbon monoxide entry into the vehicle body is a properly maintained engine exhaust system.

If you notice a change in the sound of the exhaust system; or if exhaust fumes can be detected inside the vehicle; or when the underside or rear of the vehicle is

damaged; have an authorized technician inspect the complete exhaust system and adjacent body areas for broken, damaged, deteriorated, or mispositioned parts. Open seams or loose connections could permit exhaust fumes to seep into the passenger compartment. In addition, have the exhaust system inspected each time the vehicle is raised for lubrication or oil changes. Replace as required.

WARNING!

- Exhaust gases can injure or kill. They contain Carbon Monoxide (CO), which is colorless and odorless. Breathing it can make you unconscious and can eventually poison you → page 185.
- A hot exhaust system can start a fire if you park over materials that can burn, such as grass or leaves, and those materials that come into contact with your exhaust system. Do not park or operate your vehicle in areas where your exhaust system can contact anything that can burn.

CAUTION!

- The catalytic converter requires the use of unleaded fuel only. Leaded gasoline will destroy the effectiveness of the catalyst as an emissions control device and may seriously reduce engine performance and cause serious damage to the engine.
- Damage to the catalytic converter can result if your vehicle is not kept in proper operating condition. In the event of engine malfunction, particularly involving engine misfire or other apparent loss of performance, have your vehicle serviced promptly. Continued operation of your vehicle with a severe

(Continued)

CAUTION!

malfunction could cause the converter to overheat, resulting in possible damage to the converter and vehicle.

Under normal operating conditions, the catalytic converter will not require maintenance. However, it is important to keep the engine properly tuned to ensure proper catalyst operation and prevent possible catalyst damage.

NOTE:

Intentional tampering with emissions control systems can result in civil penalties being assessed against you.

In unusual situations involving grossly malfunctioning engine operation, a scorching odor may suggest severe and abnormal catalyst overheating. If this occurs, stop the vehicle, turn off the engine and allow it to cool. Service, including a tune-up to manufacturer's specifications, should be obtained immediately.

To minimize the possibility of catalytic converter damage:

- Do not interrupt the ignition when the transmission is in gear and the vehicle is in motion.
- Do not try to start the vehicle by pushing or towing the vehicle.
- Do not idle the engine with any ignition components disconnected or removed, such as during diagnostic testing, or for prolonged periods during very rough idle or malfunctioning operating conditions.

COOLING SYSTEM

WARNING!

- You or others can be badly burned by hot engine coolant (antifreeze) or steam from your radiator. If you see or hear steam coming from under the hood, do not open the hood until the radiator has had time to cool. Never open a cooling system pressure cap when the radiator or coolant bottle is hot.
- Keep hands, tools, clothing, and jewelry away from the radiator cooling fan when the hood is raised. The fan starts automatically and may start at any time, whether the engine is running or not.
- When working near the radiator cooling fan, disconnect the fan motor lead and turn the ignition to the OFF mode. The fan is temperature controlled and can start at any time the ignition is in the ON mode.

Coolant Checks

Check the engine coolant (antifreeze) protection every 12 months (before the onset of freezing weather, where applicable). If the engine coolant is dirty, the system should be drained, flushed, and refilled with fresh OAT coolant (conforming to MS-12106) only by an authorized dealer. Check the front of the A/C condenser for any accumulation of bugs, leaves, etc. If dirty, clean by gently spraying water from a garden hose vertically down the face of the condenser.

Cooling System — Drain, Flush And Refill

NOTE:

Some vehicles require special tools to add coolant properly. Failure to fill these systems properly could lead to severe internal engine damage. If any coolant is needed to be added to the system please contact an authorized dealer.

If the engine coolant (antifreeze) is dirty or contains visible sediment, have an authorized dealer clean and flush with OAT coolant (conforming to MS.90032).

For the proper maintenance intervals ↗ page 213.

Selection Of Coolant

For further information ↗ page 265.

NOTE:

- Mixing of engine coolant (antifreeze) other than specified Organic Additive Technology (OAT) engine coolant, may result in engine damage and may decrease corrosion protection. OAT engine coolant is different and should not be mixed with Hybrid Organic Additive Technology (HOAT) engine coolant or any "globally compatible" coolant. If a non-OAT engine coolant is introduced into the cooling system in an emergency, the cooling system will need to be drained, flushed, and refilled with fresh OAT coolant (conforming to MS.90032), by an authorized dealer as soon as possible.
- Do not use water alone or alcohol-based engine coolant products. Do not use additional rust inhibitors or antirust products, as they may not be compatible with the radiator engine coolant and may plug the radiator.

- This vehicle has not been designed for use with propylene glycol-based engine coolant. Use of propylene glycol-based engine coolant is not recommended.
- Some vehicles require special tools to add coolant properly. Failure to fill these systems properly could lead to severe internal engine damage. If any coolant is needed to be added to the system please contact an authorized dealer.

Adding Coolant

The vehicle has been built with an improved engine coolant (OAT coolant conforming to MS.90032) that allows extended maintenance intervals. This engine coolant (antifreeze) can be used up to 10 years or 150,000 miles (240,000 km) before replacement. To prevent reducing this extended maintenance period, it is important to use the same engine coolant (OAT coolant conforming to MS.90032) throughout the life of your vehicle.

The vehicle has been built with an improved engine coolant (OAT coolant conforming to MS.90032) that allows extended maintenance intervals. This engine coolant (antifreeze) can be used up to 10 years or 240,000 km (150,000 miles) before replacement. To prevent reducing this extended maintenance period, it is important to use the same engine coolant (OAT coolant conforming to MS.90032) throughout the life of your vehicle.

The vehicle has been built with an improved engine coolant (OAT coolant conforming to MS.90032) that allows extended maintenance intervals. This engine coolant (antifreeze) can be used up to 10 years or 240,000 km before replacement. To prevent reducing

this extended maintenance period, it is important to use the same engine coolant (OAT coolant conforming to MS.90032) throughout the life of your vehicle.

Please review these recommendations for using OAT engine coolant that meets the requirements of the manufacturer Material Standard MS.90032. When adding engine coolant:

- We recommend using Mopar® Antifreeze/Coolant 10 Year/150,000 Mile (240,000 km) Formula OAT that meets the requirements of the manufacturer Material Standard MS.90032.
- We recommend using Mopar® Antifreeze/Coolant 10 Year/240,000 km (150,000 Mile) Formula OAT that meets the requirements of the manufacturer Material Standard MS.90032.
- We recommend using Mopar® Antifreeze/Coolant 10 Year/240,000 km Formula OAT that meets the requirements of the manufacturer Material Standard MS.90032.
- Mix a minimum solution of 50% OAT engine coolant that meets the requirements of the manufacturer Material Standard MS.90032 and distilled water. Use higher concentrations (not to exceed 70%) if temperatures below -34°F (-37°C) are anticipated. Please contact an authorized dealer for assistance.
- Mix a minimum solution of 50% OAT engine coolant that meets the requirements of the manufacturer Material Standard MS.90032 and distilled water. Use higher concentrations (not to exceed 70%) if temperatures below -37°C (-34°F) are anticipated. Please contact an authorized dealer for assistance.
- Mix a minimum solution of 50% OAT engine coolant that meets the requirements of the manufacturer Material Standard MS.90032 and distilled water.

Use higher concentrations (not to exceed 70%) if temperatures below -37°C are anticipated. Please contact an authorized dealer for assistance.

- Use only high purity water such as distilled or deionized water when mixing the water/engine coolant solution. The use of lower quality water will reduce the amount of corrosion protection in the engine cooling system.

NOTE:

- It is the owner's responsibility to maintain the proper level of protection against freezing according to the temperatures occurring in the area where the vehicle is operated.
- Some vehicles require special tools to add coolant properly. Failure to fill these systems properly could lead to severe internal engine damage. If any coolant is needed to be added to the system, please contact an authorized dealer.
- Mixing engine coolant types is not recommended and can result in cooling system damage. If HOAT and OAT coolant are mixed in an emergency, have an authorized dealer drain, flush, and refill with OAT coolant (conforming to MS.90032) as soon as possible.

Cooling System Pressure Cap

The cap must be fully tightened to prevent loss of engine coolant (antifreeze), and to ensure that engine coolant will return to the radiator from the coolant recovery tank.

The cap should be inspected and cleaned if there is any accumulation of foreign material on the sealing surfaces.

WARNING!

- Do not open hot engine cooling system. Never add engine coolant (antifreeze) when the engine is overheated. Do not loosen or remove the cap to cool an overheated engine. Heat causes pressure to build up in the cooling system. To prevent scalding or injury, do not remove the pressure cap while the system is hot or under pressure.
- Do not use a pressure cap other than the one specified for your vehicle. Personal injury or engine damage may result.

Disposal Of Used Coolant

Used ethylene glycol-based coolant (antifreeze) is a regulated substance requiring proper disposal. Check with your local authorities to determine the disposal rules for your community. To prevent ingestion by animals or children, do not store ethylene glycol-based coolant in open containers or allow it to remain in puddles on the ground. If ingested by a child or pet, seek emergency assistance immediately. Clean up any ground spills immediately.

Coolant Level

The coolant expansion bottle provides a quick visual method for determining that the coolant level is adequate. With engine off and cold, the level of the engine coolant (antifreeze) in the bottle should be between the "MIN" and "MAX" marks.

Cooling System Notes

NOTE:

When the vehicle is stopped after a few miles/kilometers of operation, you may observe vapor coming from the front of the engine compartment. This is normally a result of moisture from rain, snow, or high humidity accumulating on the radiator and being vaporized when the thermostat opens, allowing hot engine coolant (antifreeze) to enter the radiator.

If an examination of your engine compartment shows no evidence of radiator or hose leaks, the vehicle may be safely driven. The vapor will soon dissipate.

- Do not overfill the coolant expansion bottle.
- Check the coolant freeze point in the radiator and in the coolant expansion bottle. If engine coolant needs to be added, the contents of the coolant expansion bottle must also be protected against freezing.
- If frequent engine coolant additions are required, the cooling system should be pressure tested for leaks.
- Maintain engine coolant concentration at a minimum of 50% OAT coolant (conforming to MS.90032) and distilled water for proper corrosion protection of your engine which contains aluminum components.
- Make sure that the coolant expansion bottle overflow hoses are not kinked or obstructed.
- Keep the front of the radiator clean. If your vehicle is equipped with air conditioning, keep the front of the condenser clean.

- Do not change the thermostat for Summer or Winter operation. If replacement is ever necessary, install **ONLY** the correct type thermostat. Other designs may result in unsatisfactory engine cooling performance, poor gas mileage, and increased emissions.

BRAKE SYSTEM

In order to ensure brake system performance, all brake system components should be inspected periodically ↪ page 213.

WARNING!

Riding the brakes can lead to brake failure and possibly a collision. Driving with your foot resting or riding on the brake pedal can result in abnormally high brake temperatures, excessive lining wear, and possible brake damage. You would not have your full braking capacity in an emergency.

Fluid Level Check — Brake Master Cylinder

The fluid level of the master cylinder should be checked when performing under the hood service or immediately if the Brake System Warning Light indicates system failure. If necessary, add fluid to bring level within the designated marks on the side of the reservoir of the brake master cylinder. Be sure to clean the top of the master cylinder area before removing cap. With disc brakes the fluid level can be expected to fall as the brake linings wear. However, an unexpected drop in fluid level may be caused by a leak and a system check should be conducted ↪ page 265.

WARNING!

- Use only the manufacturer recommended brake fluid ↪ page 265. Using the wrong type of brake fluid can severely damage your brake system and/or impair its performance. The proper type of brake fluid for your vehicle is also identified on the original factory installed hydraulic master cylinder reservoir.
- To avoid contamination from foreign matter or moisture, use only new brake fluid or fluid that has been in a tightly closed container. Keep the master cylinder reservoir cap secured at all times. Brake fluid in an open container absorbs moisture from the air resulting in a lower boiling point. This may cause it to boil unexpectedly during hard or prolonged braking, resulting in sudden brake failure. This could result in a collision.
- Overfilling the brake fluid reservoir can result in spilling brake fluid on hot engine parts, causing the brake fluid to catch fire. Brake fluid can also damage painted and vinyl surfaces, care should be taken to avoid its contact with these surfaces.
- Do not allow petroleum-based fluid to contaminate the brake fluid. Brake seal components could be damaged, causing partial or complete brake failure. This could result in a collision.

AUTOMATIC TRANSMISSION

Selection Of Lubricant

It is important to use the proper transmission fluid to ensure optimum transmission performance and life. Use the manufacturer specified transmission fluid ↪ page 265. It is important to maintain the transmission fluid at the correct level using the recommended fluid.

NOTE:

No chemical flushes should be used in any transmission; only the approved lubricant should be used.

CAUTION!

Using a transmission fluid other than the manufacturer recommended fluid may cause deterioration in transmission shift quality and/or torque converter shudder ↪ page 265.

Special Additives

The manufacturer strongly recommends against using any special additives in the transmission. Automatic Transmission Fluid (ATF) is an engineered product and its performance may be impaired by supplemental additives. Therefore, do not add any fluid additives to the transmission. The only exception to this policy is the use of special dyes for diagnosing fluid leaks in 9-speed transmissions. Avoid using transmission sealers as they may adversely affect seals.

CAUTION!

Do not use chemical flushes in your transmission as the chemicals can damage your transmission components. Such damage is not covered by the New Vehicle Limited Warranty.

Fluid Level Check

The fluid level is preset at the factory and does not require adjustment under normal operating conditions. Routine fluid level checks are not required, therefore the transmission filler tube is capped and no dipstick is provided. An authorized dealer can check your transmission fluid level using a special service dipstick. If you notice fluid leakage or transmission malfunction, visit an authorized dealer immediately to have the transmission fluid level checked. Operating the vehicle with an improper fluid level can cause severe transmission damage.

CAUTION!

If a transmission fluid leak occurs, visit an authorized dealer immediately. Severe transmission damage may occur. An authorized dealer has the proper tools to adjust the fluid level accurately.

Fluid And Filter Changes

Under normal operating conditions, the fluid installed at the factory will provide satisfactory lubrication for the life of the vehicle.

Routine fluid and filter changes are not required. However, change the fluid and filter if the fluid becomes contaminated (with water, etc.), or if the transmission is disassembled for any reason.

FUSES

General Information

The fuses protect electrical systems against excessive current.

When a device does not work, you must check the fuse element inside the blade fuse for a break/melt.

Also, please be aware that using power outlets for extended periods of time with the engine off may result in vehicle battery discharge.

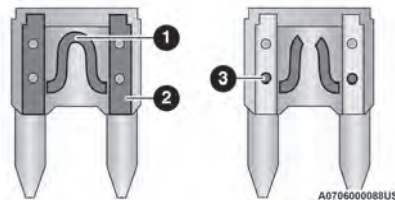

Blade Fuses

- 1 — Fuse Element
- 2 — Blade Fuse with a good/functional fuse element
- 3 — Blade Fuse with a bad/not functional fuse element (blown fuse)

WARNING!

- When replacing a blown fuse, always use an appropriate replacement fuse with the same amp rating as the original fuse. Never replace a fuse with another fuse of higher amp rating. Never replace a blown fuse with metal wires or any other material. Do not place a fuse inside a circuit breaker cavity or vice versa. Failure to use proper fuses may result in serious personal injury, fire and/or property damage.
- Before replacing a fuse, make sure that the ignition is off and that all the other services are switched off and/or disengaged.
- If the replaced fuse blows again, contact an authorized dealer.
- If a general protection fuse for safety systems (air bag system, braking system), power unit systems, (engine system, transmission system) steering system or Body Control Module (BCM) blows, contact an authorized dealer.

CAUTION!

If it is necessary to wash the engine compartment, take care not to directly hit the fuse box, and the windshield wiper motor with water.

3.6 Liter — Underhood Fuses

The Front Power Distribution Center is located on the driver's side of the engine compartment. To access the fuses, remove the cover.

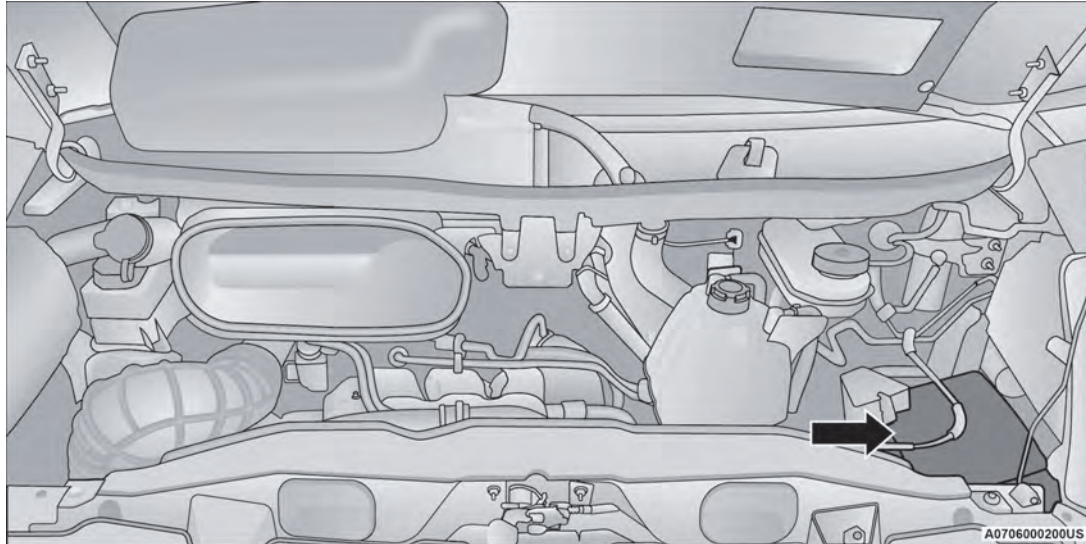

Front Power Distribution Center

Removal of the two cover screws is necessary before accessing the fuses.

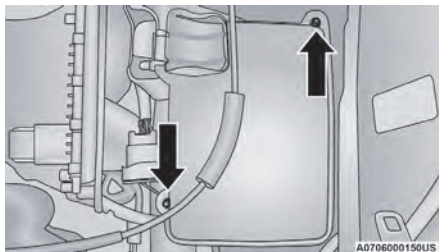

Fuse Access Cover Screw Location

The ID number of the electrical component corresponding to each fuse can be found on the back of the cover.

Cavity	Maxi Fuse	Mini Fuse	Description
		* If Equipped	
F01	50 Amp Red	-	Electronic Stability Control (ESC) Pump
F02	20 Amp Yellow (3.6 Gasoline Engine)	-	Starter Relay
F03	30 Amp Green	-	VSIM *
F04	50 Amp Red (3.6 Gasoline Engine)	-	Secondary Power Distribution Center (PDC) / Trans Power ECU / Vacuum Pump / KL30 for the Shifter Transmission Module [STM]
F05	50 Amp Red (3.6 Gasoline Engine)	-	EPB Valves & MOC
F06	40 Amp Orange (non A/C) 60 Amp Blue (A/C)	-	Engine Cooling Fan - 2nd Speed
F07	50 Amp Red	-	Engine Cooling Fan - 1st Speed
F08	40 Amp Orange	-	Passenger Compartment Blower
F09	-	15 Amp Blue	Rear Power Outlet
F10	-	15 Amp Blue	Horn
F14	-	20 Amp Yellow	Power Outlet
F15	-	-	Spare

Cavity	Maxi Fuse	Mini Fuse	Description
		* If Equipped	
F16	-	7.5 Amp Brown	KL15 ECM/ KL15 Starter Relay Coil
F17	-	20 Amp Yellow	Engine Control Module (ECM) / Injectors
F18	-	7.5 Amp Brown	KL30 Engine Control Module (ECM) / KL30 Main Relay Coil
F19	-	7.5 Amp Brown	A/C Compressor *
F20	-	30 Amp Green	Windshield Wiper
F21	-	15 Amp Blue	Fuel Pump
F22	-	20 Amp Yellow	Engine Control Module (ECM) / Ignition Coils
F23	-	30 Amp Green	TT MOD
F24	-	7.5 Amp Brown	KL15 Vacuum Pump Relay Coil
F30	-	15 Amp Blue	Heated Mirrors

Front PDC Additional Fuses

The additional fuse box is located inside the front PDC Box.

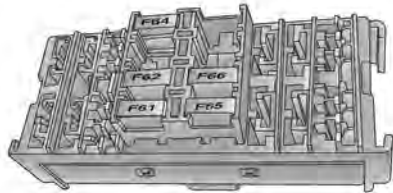

A070600096US

Front Power Distribution Center Additional Fuses

Cavity	Mini Fuse	Description
* If Equipped		
F61	30 Amp Green	Vacuum Pump
F62	30 Amp Green	Transmission Power RELE
F63	5 Amp Beige	Backup Alarm
F64	10 Amp Red	Heated Steering Wheel
F65	15 Amp Blue	Trailer Tow Mod
F66	15 Amp Blue	Trailer Tow Mod
F67	5 Amp Beige	Rear Roll Up Door *
F68	5 Amp Beige	Shifter Transmission Module (STM)

Battery Electric Vehicle (BEV) — Underhood Fuses

The Front Power Distribution Center is located on the driver's side of the engine compartment. To access the fuses, remove the cover.

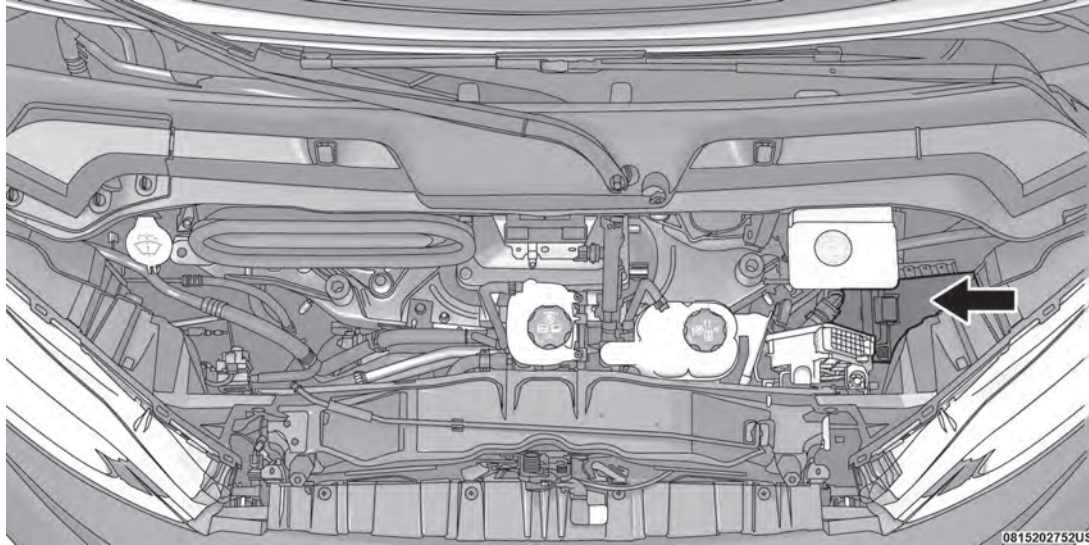

Front Power Distribution Center

0815202752US

Removal of the two cover screws is necessary before accessing the fuses.

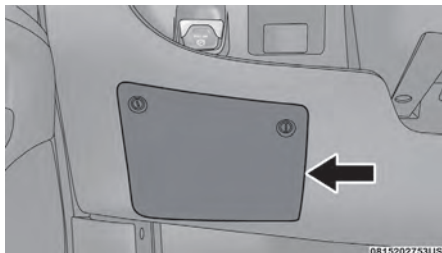

Fuse Access Cover Screw Location

The ID number of the electrical component corresponding to each fuse can be found on the back of the cover.

Cavity	Maxi Fuse	Mini Fuse	Description
* If Equipped			
F01	50 Amp Red	-	Electronic Stability Control (ESC) Pump
F02	80 Amp White	-	PECP - BCP - AHP - ESM/PRND - EVCU
F03	30 Amp Green	-	VSIM *
F04	50 Amp Red	-	IDCM/CPIM - IBS - BCIM - BPCM - EDM - CPV - Heated SteeringWheel-Roll up door
F05	50 Amp Red	-	Electronic Parking Brake (EPB)
F06	80 Amp White	-	EPS
F07	-	-	Spare
F08	40 Amp Orange	-	Passenger Compartment Blower
F09	-	15 Amp Blue	Rear Power Outlet
F10	-	15 Amp Blue	Horn
F11	-	5 Amp Beige	EXVM Valve
F14	-	20 Amp Yellow	Power Outlet
F15	-	-	Spare

Cavity	Maxi Fuse	Mini Fuse	Description
* If Equipped			
F17	-	5 Amp Beige	EAC Compressor
F18	-	5 Amp Beige	ECH
F19	-	-	Spare
F20	-	30 Amp Green	Windshield Wiper
F21	-	5 Amp Beige	BCH
F23	-	30 Amp Green	TTM
F24	-	-	Spare
F30	-	15 Amp Blue	Heated Mirrors

Front PDC Additional Fuses

The additional fuse box is located inside the front PDC Box.

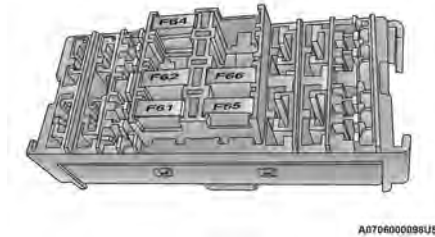

A070600098U5

Front Power Distribution Center Additional Fuses

Cavity	Mini Fuse	Description
* If Equipped		
F61	10 Amp Red	KL30C HVIL
F62	5 Amp Beige	CPV
F63	5 Amp Beige	Backup Alarm

Cavity	Mini Fuse	Description
* If Equipped		
F64	10 Amp Red	Heated Steering Wheel
F65	15 Amp Blue	Trailer Tow mod
F66	15 Amp Blue	Trailer Tow mod
F67	5 Amp Beige	Rear Roll up door
F68	5 Amp Beige	Netradyne

Front Power Distribution Center Additional Fuses

The additional fuse box is located inside the front PDC Box.

Cavity	Mini Fuse	Description
* If Equipped		
F01	20 Amp Yellow	PECP
F02	15 Amp Blue	AHP
F03	20 Amp Yellow	BCP
F04	5 Amp Beige	ESM
F05	5 Amp Beige	Ajar Sensor Pocket Door
F06	10 Amp Red	EVCU
F07	10 Amp Red	EVCU
F08	25 Amp White	EVCU
F09	5 Amp Beige	EDM
F10	5 Amp Beige	EDM
F11	20 Amp Yellow	Park Pawl
F12	20 Amp Yellow	Park Pawl
F13	7.5 Amp Brown	IDCM
F15	5 Amp Beige	BCIM/CPIM
F17	5 Amp Beige	IBS

3.6 Liter – Interior Fuses

The interior fuse panel is part of the Body Control Module (BCM) and is located on the driver's side under the instrument panel.

NOTE:

Please contact an authorized dealer for BCM fuse replacement.

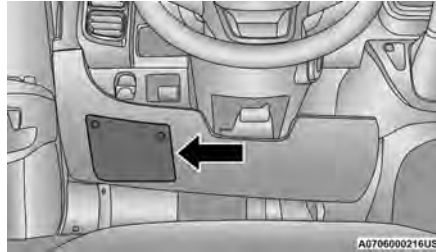

Fuse Panel

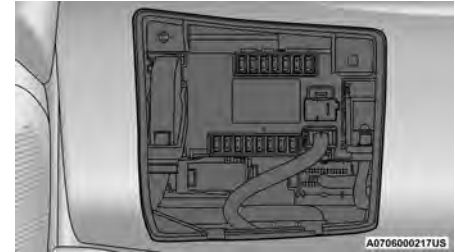

Fuse Panel Cavity Locations

Cavity	Mini Fuse	Description
F31	5 Amp Beige	INT/A
F33	7.5 Amp Brown	+30 TTM
F34	7.5 Amp Brown	Clearance Lights
F36	15 Amp Blue	+30 (ACM / USB Power Out / USB Recharge / TBM / RRM / DLC)
F37	7.5 Amp Brown	INT (IPC – DASM / AEB)
F38	20 Amp Yellow	Central Locking
F42	5 Amp Beige	INT (BSM / BRAKE NC) / EPS
F43	20 Amp Yellow	Bi-Directional Washer Pump
F47	20 Amp Yellow	Driver Power Window
F48	20 Amp Yellow	Passenger Power Window
F49	5 Amp Beige	INT (RRM / TTM / SBDU / XAN / JHC / RFX)
F50	7.5 Amp Brown	INT (ORC)
F51	7.5 Amp Brown	INT (REAR CAMERA-AUX) / HALF / DRVW/ PAM / CVPM / EMC / TCM / STM / ASS / SGW / HVAC
F53	7.5 Amp Brown	+30 (IPC) + Keyless – GO / Passive Entry / Brake NO / EPB SW

Cavity	Mini Fuse	Description
F94	15 Amp Blue	Not Used

Battery Electric Vehicle (BEV) — Interior Fuses

The interior fuse panel is part of the Body Control Module (BCM) and is located on the driver's side under the instrument panel.

NOTE:

Please contact an authorized dealer for BCM fuse replacement.

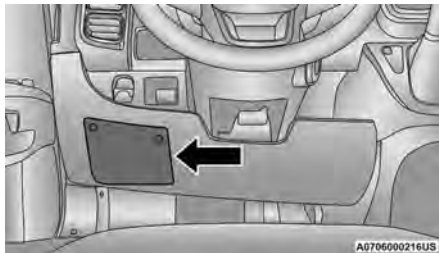

Fuse Panel

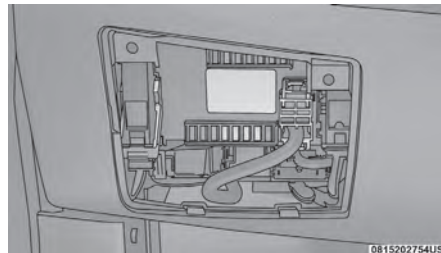

Fuse Panel Cavity Locations

Cavity	Mini Fuse	Description
F31	5 Amp Beige	INT/A BCM - EVCU
F32	7.5 Amp Brown	Passenger compartment interior dome lighting (+battery 12V)
F33	7.5 Amp Brown	+30 Trailer Tow Mod
F34	7.5 Amp Brown	Clearance Lights
F36	15 Amp Blue	+30 (ACM / USB Power Outlet / USB Recharge / TBM / RRM / DLC)
F37	7.5 Amp Brown	INT IPC - DASM/AEB - QVPM
F38	20 Amp Yellow	Door Lock
F42	5 Amp Beige	KL15 EPS - EBAM
F43	20 Amp Yellow	Windshield Wiper
F47	20 Amp Yellow	Driver Power Window
F48	20 Amp Yellow	+30 BPCM
F49	5 Amp Beige	INT TTM - XAN - JHC - RFX

Cavity	Mini Fuse	Description
F50	7.5 Amp Brown	ORC
F51	7.5 Amp Brown	INT HALF - DRVM - PAM - CVPM - EMC - ASS - SGW - EVCU - HVAC
F53	7.5 Amp Brown	+30 IPC - Keyless-Go - Passive Entry

3.6 Liter — Right Central Pillar Fuses

The right central pillar fuse panel is located on the interior side at the base of the passenger side B-pillar.

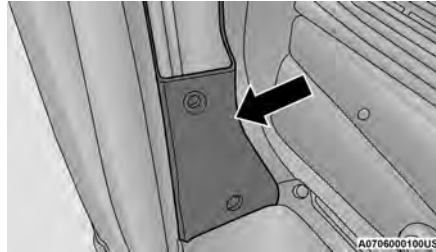

Fuse Panel Location

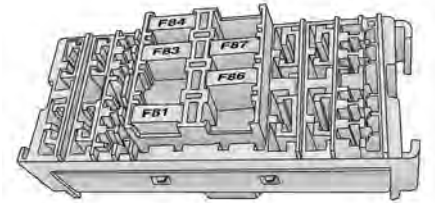

A0706000097U5

Fuse Panel

Cavity	Mini Fuse	Description
* If Equipped		
F81	7.5 Amp Brown	Seat Heater
F82	30 Amp Green	Inverter Power Outlet
F83	20 Amp Yellow	Rear Left Windows Heater
F84	20 Amp Yellow	Rear Right Windows Heater
F86	20 Amp Yellow	Auxiliary Switch (From Battery) *
F87	20 Amp Yellow	Auxiliary Switch (From Ignition) *

Battery Electric Vehicle (BEV) — Right Central Pillar Fuses

NOTE:

For Driver Seat Heater and 115V Power Inverter Fuses replacement contact the Assistance Network

BULB REPLACEMENT

Replacement Bulbs, Names, And Part Numbers

In the instance a bulb needs to be replaced, this section includes bulb description and replacement part numbers.

NOTE:

See an authorized dealer for LED bulb replacement.

Interior Bulbs	
Bulb Name	Bulb Number
Dome Lamp	C5W
Courtesy Lamp	FF500
Cargo Lamp	C5W

Exterior Bulbs	
Bulb Name	Bulb Number
Low Beam Headlamp (Halogen - If Equipped)	H11LL
High Beam Headlamp (Halogen - If Equipped)	9005LL
Low Beam Headlamp	LED
High Beam Headlamp	LED
Front Park/Turn Signal Lamps (Halogen - If Equipped)	T20
Daytime Running Lamps (Halogen - If Equipped)	T20
Front Park/Turn Signal/Daytime Running Lamps	LED
Front Side Marker Lamps (Halogen - If Equipped)	W3W
Front Side Marker Lamps	LED

Exterior Bulbs	
Bulb Name	Bulb Number
Front Fog Lamps (Halogen – If Equipped)	PSX24W
Front Fog Lamps	LED
Rear Tail/Stop Lamps	W21/5W
Rear Turn Signal Lamps	WY21W
Rear Backup Lamps	921
Rear Side Marker Lamps	W5W
License Plate Lamps (Halogen – If Equipped)	C5W
License Plate Lamps (RR Roll Up Door – If Equipped)	LED
Front Roof Lamps	WY5W
Rear Roof Lamps	W3W
NOTE: Numbers refer to commercial bulb types that can be purchased from an authorized dealer. If a bulb needs to be replaced, visit an authorized dealer.	

Replacing Exterior Bulbs

HEADLAMPS LOW BEAM AND HIGH BEAM

See the following steps to replace:

1. Disconnect the negative battery terminal.
2. Remove the headlamp retaining screws.
3. Remove the headlamp assembly from the vehicle (by moving the headlamp to release the lower slides from the headlamp mounting on the vehicle).
4. Disconnect the headlamp harness electrical connector.
5. Remove appropriate plastic cap from the back of the headlamp housing.

6. Detach the wire connector from the bulb.
7. Rotate the bulb counterclockwise and remove it from the reflector.
8. Install a new bulb.
9. Rotate the new bulb clockwise to lock it in place.
10. Reinstall the wire connector.
11. Reinstall the access cap and rotate to lock into place.
12. Connect the headlamp harness electrical connector.
13. Carefully reinstall headlamp in the same position on the vehicle, so as not to affect headlamp aiming.

14. Reinstall the headlamp screws.
15. Connect the negative battery terminal.
16. Check lights to make sure they are operating correctly.

FRONT TURN SIGNAL/PARKING LAMPS

See the following steps to replace:

1. Remove one retaining screw on the lower headlamp filler panel. Remove filler panel.
2. Remove two retaining screws on the upper headlamp filler panel. Remove filler panel.
3. Remove one upper retaining screw from the headlamp housing.

- Remove two lower retaining screws from the headlamp housing.
- Pull Headlamp forward, disconnect the harness electrical connector and remove the headlamp assembly from vehicle.
- Rotate the bulb counterclockwise and remove.
- Install the bulb into socket, and rotate bulb/socket clockwise into lamp locking it in place.
- Carefully reinstall headlamp in the same position on the vehicle, so as not to affect headlamp aiming.
- Install the one upper retaining screw on headlamp housing.
- Install the two lower retaining screws on headlamp housing.
- Carefully reinstall the lower headlamp filler panel and one retaining screw.
- Carefully reinstall the upper headlamp filler panel and two retaining screws.

DAYTIME RUNNING LAMP (DRL)/FRONT SIDE MARKER LAMP

See the following steps to replace:

- Remove one retaining screw on the lower headlamp filler panel. Remove filler panel.
- Remove two retaining screws on the upper headlamp filler panel. Remove filler panel.
- Remove one upper retaining screw from the headlamp housing.
- Remove two lower retaining screws from the headlamp housing.

- Pull Headlamp forward, disconnect the harness electrical connector and remove the headlamp assembly from vehicle.
- Remove the (DRL), side marker bulb by pulling straight out.
- Replace lamp as required and lock in place.
- Reinstall plastic cap.
- Carefully reinstall headlamp in the same position on the vehicle, as not to affect headlamp aiming.
- Install the one upper retaining screw on the headlamp housing.
- Install the two lower retaining screws on the headlamp housing.
- Carefully reinstall the lower headlamp filler panel and one retaining screw.
- Carefully reinstall the upper headlamp filler panel and two retaining screws.

See an authorized dealer for LED bulb replacement.

FRONT FOG LAMPS

See the following steps to replace:

- Turn front wheels inboard to access cover in wheel liner.
- Open the cover on the front of the wheel liner.
- Remove connection and replace the bulb.
- Connect the wire and rotate bulb/socket clockwise into lamp locking it in place.
- Reinstall the plastic cap and close the cover on the wheel liner.

See an authorized dealer for LED bulb replacement.

FRONT, REAR ROOF LAMPS

See the following steps to replace:

- Remove two screw and remove the lamp assembly.
- Remove the socket bulb by turning counterclockwise.
- Remove bulb and replace as needed.
- Reinstall the bulb socket and rotate clockwise to lock in place.
- Reinstall lamp.

REAR TAIL, STOP, BACKUP, TURN SIGNAL AND REAR SIDE MARKER LAMPS

See the following steps to replace:

- Open rear doors.
- Remove the seven (7) fasteners from the rear access cover and remove cover to gain access to the tail lamp assembly fasteners.

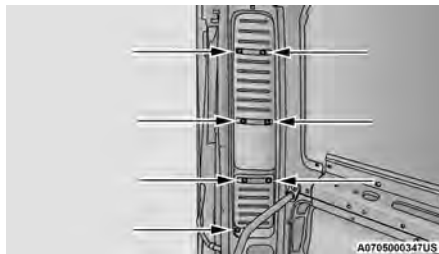

Rear Access Cover

- Remove the two (2) 17 mm tail lamp assembly fasteners.

4. Disconnect the tail lamp harness connector and remove tail light assembly from the vehicle.
5. Remove the tail/stop, turn signal, backup and rear side marker bulb/socket by rotating counterclockwise.
6. Remove the bulb and replace as needed.
7. Reinstall bulb/socket and rotate clockwise to lock in place.
8. Reinstall lamp.

Replacing Interior Bulbs

CARGO LAMP

See the following steps to replace:

1. Using a suitable tool, remove either the lamp above the back door or the sliding door lamp as needed and disconnect it.

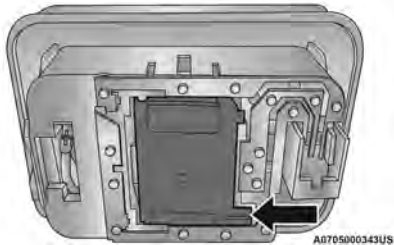

Rear Cargo Lamp Bulb Access

2. Using a suitable tool, pull open the metal bulb access on the back of the housing.

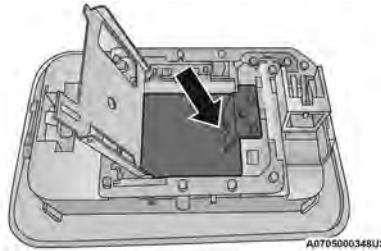

Cargo Lamp Bulb Location

3. Remove and install the replacement bulb.
4. Close the bulb access, connect the lamp and install the lamp into place.

DOME LAMPS

See the following steps to replace:

1. Using a suitable tool, insert the tip at the location shown and press inward to the lamp to relieve the spring tension. This will allow you to easily drop the dome lamp assembly from its bracket and disconnect the lamp.

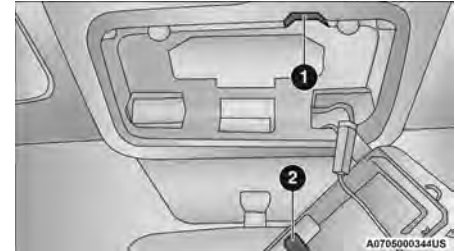

Dome Lamp Assembly Location

- 1 – Spring Tension Relief Access
- 2 – Dome Lamp Assembly

2. Using a suitable tool, flex the housing to lift the light pod cover away from the unit.

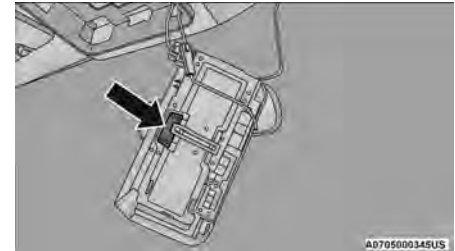

Dome Lamp Light Pod Cover

3. Remove and replace the bulbs as needed.

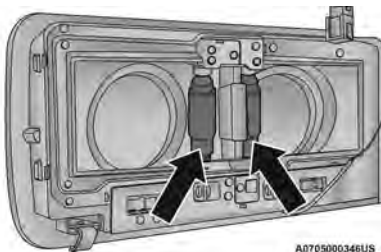

Dome Lamp Light Bulbs

4. Close the housing cover making sure it snaps together properly and connect the lamp.
5. Install overhead console into place making sure to seat the assembly's forward end first and then snapping it flush so that the tension spring is fully seating in the housing.

TIRES

TIRE SAFETY INFORMATION

Tire safety information will cover aspects of the following information: Tire Markings, Tire Identification Numbers, Tire Terminology and Definitions, Tire Pressures, and Tire Loading.

Tire Markings

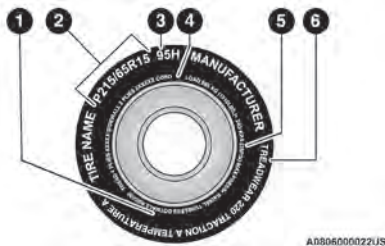

Tire Markings

- 1 — US DOT Safety Standards Code (TIN)
- 2 — Size Designation
- 3 — Service Description
- 4 — Maximum Load
- 5 — Maximum Pressure
- 6 — Treadwear, Traction and Temperature Grades

NOTE:

- P (Passenger) — Metric tire sizing is based on US design standards. P-Metric tires have the letter "P" molded into the sidewall preceding the size designation. Example: P215/65R15 95H.
- European — Metric tire sizing is based on European design standards. Tires designed to this standard have the tire size molded into the sidewall beginning with the section width. The letter "P" is absent from this tire size designation. Example: 215/65R15 96H.
- LT (Light Truck) — Metric tire sizing is based on US design standards. The size designation for LT-Metric tires is the same as for P-Metric tires except for the letters "LT" that are molded into the sidewall preceding the size designation. Example: LT235/85R16.
- Temporary spare tires are designed for temporary emergency use only. Temporary high pressure compact spare tires have the letter "T" or "S" molded into the sidewall preceding the size designation. Example: T145/80D18 103M.
- High flotation tire sizing is based on US design standards and it begins with the tire diameter molded into the sidewall. Example: 31x10.5 R15 LT.

TIRE SIZING CHART

EXAMPLE:
Example Size Designation: P215/65R15XL 95H, 215/65R15 96H, LT235/85R16C, T145/80D18 103M, 31x10.5 R15 LT
<p>P = Passenger car tire size based on US design standards, or "...blank..." = Passenger car tire based on European design standards, or LT = Light truck tire based on US design standards, or T or S = Temporary spare tire or 31 = Overall diameter in inches (in) 215, 235, 145 = Section width in millimeters (mm) 65, 85, 80 = Aspect ratio in percent (%) <ul style="list-style-type: none"> ● Ratio of section height to section width of tire, or 10.5 = Section width in inches (in)</p>
<p>R = Construction code <ul style="list-style-type: none"> ● "R" means radial construction, or ● "D" means diagonal or bias construction 15, 16, 18 = Rim diameter in inches (in)</p>
Service Description:
<p>95 = Load Index <ul style="list-style-type: none"> ● A numerical code associated with the maximum load a tire can carry H = Speed Symbol <ul style="list-style-type: none"> ● A symbol indicating the range of speeds at which a tire can carry a load corresponding to its load index under certain operating conditions ● The maximum speed corresponding to the speed symbol should only be achieved under specified operating conditions (i.e., tire pressure, vehicle loading, road conditions, and posted speed limits) </p>
<p>Load Identification: Absence of the following load identification symbols on the sidewall of the tire indicates a Standard Load (SL) tire: <ul style="list-style-type: none"> ● XL = Extra load (or reinforced) tire, or ● LL = Light load tire or ● C, D, E, F, G = Load range associated with the maximum load a tire can carry at a specified pressure </p>
Maximum Load – Maximum load indicates the maximum load this tire is designed to carry
Maximum Pressure – Maximum pressure indicates the maximum permissible cold tire inflation pressure for this tire

Tire Identification Number (TIN)

The TIN may be found on one or both sides of the tire; however, the date code may only be on one side. Tires with white sidewalls will have the full TIN, including the date code, located on the white sidewall side of the tire. Look for the TIN on the outboard side of black sidewall tires as mounted on the vehicle. If the TIN is not found on the outboard side, then you will find it on the inboard side of the tire.

EXAMPLE:

DOT MA L9 ABCD 0301

DOT = Department of Transportation

- This symbol certifies that the tire is in compliance with the US Department of Transportation tire safety standards and is approved for highway use

MA = Code representing the tire manufacturing location (two digits)

L9 = Code representing the tire size (two digits)

ABCD = Code used by the tire manufacturer (one to four digits)

03 = Number representing the week in which the tire was manufactured (two digits)

- 03 means the 3rd week

01 = Number representing the year in which the tire was manufactured (two digits)

- 01 means the year 2001
- Prior to July 2000, tire manufacturers were only required to have one number to represent the year in which the tire was manufactured. Example: 031 could represent the 3rd week of 1981 or 1991

Tire Terminology And Definitions

Term	Definition
B-pillar	The vehicle B-pillar is the structural member of the body located behind the front door.
Cold Tire Inflation Pressure	Cold tire inflation pressure is defined as the tire pressure after the vehicle has not been driven for at least three hours, or driven less than 1 mile (1.6 km) after sitting for a minimum of three hours. Inflation pressure is measured in units of psi (pounds per square inch) or kPa (kilopascals).
Maximum Inflation Pressure	The maximum inflation pressure is the maximum permissible cold tire inflation pressure for this tire. The maximum inflation pressure is molded into the sidewall.
Recommended Cold Tire Inflation Pressure	The manufacturers recommended cold tire inflation pressure as shown on the tire placard.

Term	Definition
Tire Placard	A label permanently attached to the vehicle describing the vehicle's loading capacity, the original equipment tire sizes and the recommended cold tire inflation pressures.

Tire Loading And Tire Pressure

NOTE:

The proper cold tire inflation pressure is listed on the driver's side B-pillar or the rear edge of the driver's side door.

Check the inflation pressure of each tire, including the spare tire (if equipped), at least monthly and inflate to the recommended pressure for your vehicle.

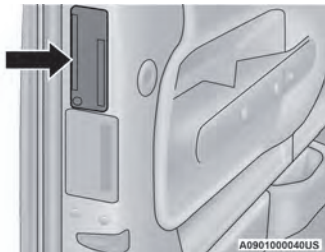

Example Tire Placard Location (Door)

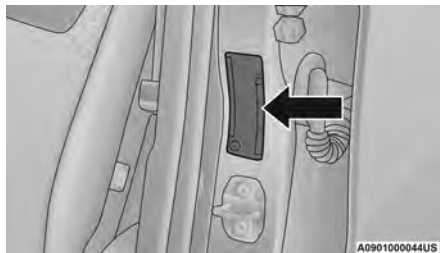

Example Tire Placard Location (B-pillar)

Tire And Loading Information Placard

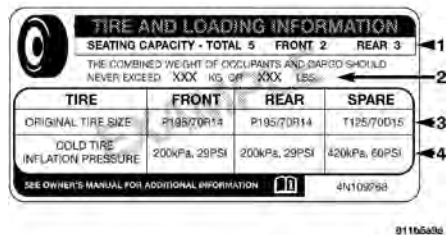

Tire And Loading Information Placard

This placard tells you important information about the:

1. Number of people that can be carried in the vehicle.
2. Total weight your vehicle can carry.
3. Tire size designed for your vehicle.
4. Cold tire inflation pressures for the front, rear, and spare tires.

Loading

The vehicle maximum load on the tire must not exceed the load carrying capacity of the tire on your vehicle. You will not exceed the tire's load carrying capacity if you adhere to the loading conditions, tire size, and cold tire inflation pressures specified on the Tire And Loading Information Placard ↪ page 127.

NOTE:

Under a maximum loaded vehicle condition, gross axle weight ratings (GAWRs) for the front and rear axles must not be exceeded.

For further information on GAWRs, vehicle loading, and trailer towing ↪ page 127.

To determine the maximum loading conditions of your vehicle, locate the statement "The combined weight of occupants and cargo should never exceed XXX kg or XXX lbs" on the Tire And Loading Information Placard. The combined weight of occupants, cargo/luggage and trailer tongue weight (if applicable) should never exceed the weight referenced here.

Steps For Determining Correct Load Limit—

- (1) Locate the statement “The combined weight of occupants and cargo should never exceed XXX kg or XXX lbs.” on your vehicle’s placard.
- (2) Determine the combined weight of the driver and passengers that will be riding in your vehicle.
- (3) Subtract the combined weight of the driver and passengers from XXX kg or XXX lbs.
- (4) The resulting figure equals the available amount of cargo and luggage load capacity. For example, if “XXX” amount equals 1400 lbs. and there will be five 150 lb passengers in your vehicle, the amount of available cargo and luggage load capacity is 650 lbs. (1400-750 (5x150) = 650 lbs.)

(5) Determine the combined weight of luggage and cargo being loaded on the vehicle. That weight may not safely exceed the available cargo and luggage load capacity calculated in Step 4.

(6) If your vehicle will be towing a trailer, load from your trailer will be transferred to your vehicle. Consult this manual to determine how this reduces the available cargo and luggage load capacity of your vehicle.

Metric Example For Load Limit

For example, if “XXX” amount equals 635 kg and there will be five 68 kg passengers in your vehicle, the amount of available cargo and luggage load capacity is 295 kg (635-340 (5x68) = 295 kg) as shown in step 4.

NOTE:

- If your vehicle will be towing a trailer, load from your trailer will be transferred to your vehicle. The following table shows examples on how to calculate total load, cargo/luggage, and towing capacities of your vehicle with varying seating configurations and number and size of occupants. This table is for illustration purposes only and may not be accurate for the seating and load carry capacity of your vehicle.
- For the following example, the combined weight of occupants and cargo should never exceed 865 lb (392 kg).

Occupants			Combined weight of occupants and cargo from Tire Placard	MINUS	Combined Occupant's weight	=	AVAILABLE Cargo/Luggage and Trailer Tongue Weight
TOTAL	FRONT	REAR					
EXAMPLE 1			865 lbs	minus	670 lbs	=	195 lbs
5	2	3					
EXAMPLE 2			865 lbs	minus	540 lbs	=	325 lbs
3	2	1					
EXAMPLE 3			865 lbs	minus	400 lbs	=	465 lbs
2	2	0					

811a4d11

WARNING!

Overloading of your tires is dangerous. Overloading can cause tire failure, affect vehicle handling, and increase your stopping distance. Use tires of the recommended load capacity for your vehicle. Never overload them.

TIRES — GENERAL INFORMATION

Tire Pressure

Proper tire inflation pressure is essential to the safe and satisfactory operation of your vehicle. Four primary areas are affected by improper tire pressure:

- Safety
- Fuel Economy
- Tread Wear
- Ride Comfort And Vehicle Stability

Safety

WARNING!

- Improperly inflated tires are dangerous and can cause collisions.
- Underinflation increases tire flexing and can result in overheating and tire failure.
- Overinflation reduces a tire's ability to cushion shock. Objects on the road and chuckholes can cause damage that result in tire failure.
- Overinflated or underinflated tires can affect vehicle handling and can fail suddenly, resulting in loss of vehicle control.
- Unequal tire pressures can cause steering problems. You could lose control of your vehicle.
- Unequal tire pressures from one side of the vehicle to the other can cause the vehicle to drift to the right or left.
- Always drive with each tire inflated to the recommended cold tire inflation pressure.

Both underinflation and overinflation affect the stability of the vehicle and can produce a feeling of sluggish response or over responsiveness in the steering.

NOTE:

- Unequal tire pressures from side to side may cause erratic and unpredictable steering response.
- Unequal tire pressure from side to side may cause the vehicle to drift left or right.

Fuel Economy

Underinflated tires will increase tire rolling resistance resulting in higher fuel consumption.

Tread Wear

Improper cold tire inflation pressures can cause abnormal wear patterns and reduced tread life, resulting in the need for earlier tire replacement.

Ride Comfort And Vehicle Stability

Proper tire inflation contributes to a comfortable ride. Overinflation produces a jarring and uncomfortable ride.

Tire Inflation Pressures

The proper cold tire inflation pressure is listed on the driver's side B-pillar or rear edge of the driver's side door.

At least once a month:

- Check and adjust tire pressure with a good quality pocket-type pressure gauge. Do not make a visual judgment when determining proper inflation. Tires may look properly inflated even when they are under-inflated.
- Inspect tires for signs of tire wear or visible damage.

CAUTION!

After inspecting or adjusting the tire pressure, always reinstall the valve stem cap. This will prevent moisture and dirt from entering the valve stem, which could damage the valve stem.

Inflation pressures specified on the placard are always "cold tire inflation pressure". Cold tire inflation pressure is defined as the tire pressure after the vehicle has not been driven for at least three hours, or driven less than 1 mile (1.6 km) after sitting for a minimum of three hours. The cold tire inflation pressure must not exceed the maximum inflation pressure molded into the tire sidewall.

Check tire pressures more often if subject to a wide range of outdoor temperatures, as tire pressures vary with temperature changes.

Tire pressures change by approximately 1 psi (7 kPa) per 12°F (7°C) of air temperature change. Keep this in mind when checking tire pressure inside a garage, especially in the Winter.

Example: If garage temperature = 68°F (20°C) and the outside temperature = 32°F (0°C) then the cold tire inflation pressure should be increased by 3 psi (21 kPa), which equals 1 psi (7 kPa) for every 12°F (7°C) for this outside temperature condition.

Tire pressure may increase from 2 to 6 psi (13 to 40 kPa) during operation. DO NOT reduce this normal pressure build-up or your tire pressure will be too low.

Tire Pressures For High Speed Operation

The manufacturer advocates driving at safe speeds and within posted speed limits. Where speed limits or conditions are such that the vehicle can be driven at high speeds, maintaining correct tire inflation pressure is

very important. Increased tire pressure and reduced vehicle loading may be required for high-speed vehicle operation. Refer to an authorized tire dealer or original equipment vehicle dealer for recommended safe operating speeds, loading and cold tire inflation pressures.

WARNING!

High speed driving with your vehicle under maximum load is dangerous. The added strain on your tires could cause them to fail. You could have a serious collision. Do not drive a vehicle loaded to the maximum capacity at continuous speeds above 75 mph (120 km/h).

Radial Ply Tires

WARNING!

Combining radial ply tires with other types of tires on your vehicle will cause your vehicle to handle poorly. The instability could cause a collision. Always use radial ply tires in sets of four. Never combine them with other types of tires.

Tire Repair

If your tire becomes damaged, it may be repaired if it meets the following criteria:

- The tire has not been driven on when flat.
- The damage is only on the tread section of your tire (sidewall damage is not repairable).
- The puncture is no greater than $\frac{1}{4}$ of an inch (6 mm).

Consult an authorized tire dealer for tire repairs and additional information.

Damaged Run Flat tires, or Run Flat tires that have experienced a loss of pressure should be replaced immediately with another Run Flat tire of identical size and service description (Load Index and Speed Symbol). Replace the tire pressure sensor as well as it is not designed to be reused.

Run Flat Tires — If Equipped

Run Flat tires allow you the capability to drive 50 miles (80 km) at 50 mph (80 km/h) after a rapid loss of inflation pressure. This rapid loss of inflation is referred to as the Run Flat mode. A Run Flat mode occurs when the tire inflation pressure is of/or below 14 psi (96 kPa). Once a Run Flat tire reaches the run flat mode it has limited driving capabilities and needs to be replaced immediately. A Run Flat tire is not repairable. When a Run Flat tire is changed after being driven under a Run Flat mode 14 psi (96 kPa) condition, please replace the TPMS sensor as it is not designed to be reused.

NOTE:

TPMS sensor must be replaced after driving the vehicle on a flat tire condition.

It is not recommended driving a vehicle loaded at full capacity or to tow a trailer while a tire is in the Run Flat mode.

See the Tire Pressure Monitoring System section for more information  page 164.

Tire Spinning

When stuck in mud, sand, snow, or ice conditions, do not spin your vehicle's wheels above 30 mph (48 km/h) or for longer than 30 seconds continuously without stopping.

Refer to "Freeing A Stuck Vehicle" for further information  page 208.

WARNING!

Fast spinning tires can be dangerous. Forces generated by excessive wheel speeds may cause tire damage or failure. A tire could explode and injure someone. Do not spin your vehicle's wheels faster than 30 mph (48 km/h) for more than 30 seconds continuously when you are stuck, and do not let anyone near a spinning wheel, no matter what the speed.

Tread Wear Indicators

Tread wear indicators are in the original equipment tires to help you in determining when your tires should be replaced.

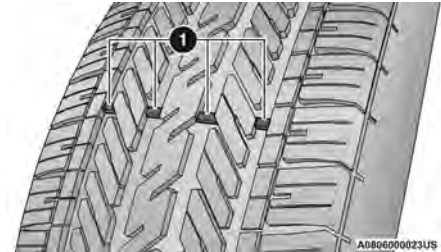

Tire Tread

1 — Tread Wear Indicators

These indicators are molded into the bottom of the tread grooves. They will appear as bands when the tread depth becomes $\frac{1}{16}$ of an inch (1.6 mm). When the tread is worn to the tread wear indicators, the tire should be replaced.

Life of Tire

The service life of a tire is dependent upon varying factors including, but not limited to:

- Driving style.
- Tire pressure - Improper cold tire inflation pressures can cause uneven wear patterns to develop across the tire tread. These abnormal wear patterns will reduce tread life, resulting in the need for earlier tire replacement.
- Distance driven.
- Performance tires, tires with a speed rating of V or higher, and Summer tires typically have a reduced tread life. Rotation of these tires per the vehicle scheduled maintenance is highly recommended.

WARNING!

Tires and the spare tire should be replaced after six years, regardless of the remaining tread. Failure to follow this warning can result in sudden tire failure. You could lose control and have a collision resulting in serious injury or death.

NOTE:

Wheel Valve Stem must be replaced as well when installing new tires due to wear and tear in existing tires.

Keep dismantled tires in a cool, dry place with as little exposure to light as possible. Protect tires from contact with oil, grease, and gasoline.

Replacement Tires

The tires on your new vehicle provide a balance of many characteristics. They should be inspected regularly for wear and correct cold tire inflation pressures. The manufacturer strongly recommends using tires equivalent to the originals in size, quality and performance when replacement is needed. Refer to the paragraph on "Tread Wear Indicators" in this section. Refer to the Tire And Loading Information Placard or the Vehicle Certification Label for the size designation of your tire. The Load Index and Speed Symbol for your tire will be found on the original equipment tire sidewall.

See the Tire Sizing Chart example found in the Tire Safety Information section of this manual for more information relating to the Load Index and Speed Symbol of a tire → page 245.

It is recommended to replace the two front tires or two rear tires as a pair. Replacing just one tire can seriously affect your vehicle's handling. If you ever replace a wheel, make sure that the wheel's specifications match those of the original wheels.

It is recommended you contact an authorized tire dealer or original equipment dealer with any questions you may have on tire specifications or capability. Failure to use equivalent replacement tires may adversely affect the safety, handling, and ride of your vehicle.

WARNING!

- Do not use a tire, wheel size, load rating, or speed rating other than that specified for your vehicle. Some combinations of unapproved tires and wheels may change suspension dimensions and performance characteristics, resulting in changes to steering, handling, and braking of your vehicle. This can cause unpredictable handling and stress to steering and suspension components. You could lose control and have a collision resulting in serious injury or death. Use only the tire and wheel sizes with load ratings approved for your vehicle.
- Never use a tire with a smaller load index or capacity, other than what was originally equipped on your vehicle. Using a tire with a smaller load index could result in tire overloading and failure. You could lose control and have a collision.
- Failure to equip your vehicle with tires having adequate speed capability can result in sudden tire failure and loss of vehicle control.

CAUTION!

Replacing original tires with tires of a different size may result in false speedometer and odometer readings.

TIRE TYPES

All Season Tires — If Equipped

All Season tires provide traction for all seasons (Spring, Summer, Autumn, and Winter). Traction levels may vary between different all season tires. All season tires can be identified by the M+S, M&S, M/S or MS designation on the tire sidewall. Use all season tires only in sets of four; failure to do so may adversely affect the safety and handling of your vehicle.

Summer Or Three Season Tires — If Equipped

Summer tires provide traction in both wet and dry conditions, and are not intended to be driven in snow or on ice. If your vehicle is equipped with Summer tires, be aware these tires are not designed for Winter or cold driving conditions. Install Winter tires on your vehicle when ambient temperatures are less than 40°F (5°C) or if roads are covered with ice or snow. For more information, contact an authorized dealer.

Summer tires do not contain the all season designation or mountain/snowflake symbol on the tire sidewall. Use Summer tires only in sets of four; failure to do so may adversely affect the safety and handling of your vehicle.

WARNING!

Do not use Summer tires in snow/ice conditions. You could lose vehicle control, resulting in severe injury or death. Driving too fast for conditions also creates the possibility of loss of vehicle control.

Snow Tires



Some areas of the country require the use of snow tires during the Winter. Snow tires can be identified by a mountain/snowflake symbol on the tire sidewall.

If you need snow tires, select tires equivalent in size and type to the original equipment tires. Use snow tires only in sets of four; failure to do so may adversely affect the safety and handling of your vehicle.

Snow tires generally have lower speed ratings than what was originally equipped with your vehicle and should not be operated at sustained speeds over 75 mph (120 km/h). For speeds above 75 mph (120 km/h) refer to original equipment or an authorized tire dealer for recommended safe operating speeds, loading and cold tire inflation pressures.

While studded tires improve performance on ice, skid and traction capability on wet or dry surfaces may be poorer than that of non-studded tires. Some states prohibit studded tires; therefore, local laws should be checked before using these tire types.

SPARE TIRES — IF EQUIPPED

NOTE:

For vehicles equipped with Tire Service Kit instead of a spare tire, please refer to “Tire Service Kit” in “In Case Of Emergency” for further information.

CAUTION!

Because of the reduced ground clearance, do not take your vehicle through an automatic car wash with a compact or limited use temporary spare installed. Damage to the vehicle may result.

For restrictions when towing with a spare tire designated for temporary emergency use → page 131.

Spare Tire Matching Original Equipped Tire And Wheel — If Equipped

Your vehicle may be equipped with a spare tire and wheel equivalent in look and function to the original equipment tire and wheel found on the front or rear axle of your vehicle. This spare tire may be used in the tire rotation for your vehicle. If your vehicle has this option, refer to an authorized tire dealer for the recommended tire rotation pattern.

NOTE:

This spare tire may not have a TPMS sensor.

Compact Spare Tire — If Equipped

The compact spare is for temporary emergency use only. You can identify if your vehicle is equipped with a compact spare by looking at the spare tire description on the Tire And Loading Information Placard located on the driver's side door opening or on the sidewall of the tire. Compact spare tire descriptions begin with the letter “T” or “S” preceding the size designation. Example: T145/80D18 103M.

T, S = Temporary Spare Tire

Since this tire has limited tread life, the original equipment tire should be repaired (or replaced) and reinstalled on your vehicle at the first opportunity.

Do not install a wheel cover or attempt to mount a conventional tire on the compact spare wheel, since the wheel is designed specifically for the compact spare tire. Do not install more than one compact spare tire and wheel on the vehicle at any given time.

WARNING!

Compact and collapsible spares are for temporary emergency use only. With these spares, do not drive more than 50 mph (80 km/h). Temporary use spares have limited tread life. When the tread is worn to the tread wear indicators, the temporary use spare tire needs to be replaced. Be sure to follow the warnings, which apply to your spare. Failure to do so could result in spare tire failure and loss of vehicle control.

WARNING!

Compact and Collapsible spares are for temporary emergency use only. With these spares, do not drive more than 50 mph (80 km/h). Temporary use spares have limited tread life. When the tread is worn to the tread wear indicators, the temporary use spare tire needs to be replaced. Be sure to follow the warnings, which apply to your spare. Failure to do so could result in spare tire failure and loss of vehicle control.

WARNING!

Limited use spares are for emergency use only. Installation of this limited use spare tire affects vehicle handling. With this tire, do not drive more than the speed listed on the limited use spare wheel. Keep inflated to the cold tire inflation pressures listed on your Tire And Loading Information Placard located on the driver's side B-pillar or the rear edge of the driver's side door. Replace (or repair) the original equipment tire at the first opportunity and reinstall it on your vehicle. Failure to do so could result in loss of vehicle control.

Collapsible Spare Tire — If Equipped

The collapsible spare is for temporary emergency use only. You can identify if your vehicle is equipped with a collapsible spare by looking at the spare tire description on the Tire And Loading Information Placard located on the driver's side door opening or on the sidewall of the tire.

Collapsible spare tire description example:
165/80-17 101P.

Since this tire has limited tread life, the original equipment tire should be repaired (or replaced) and reinstalled on your vehicle at the first opportunity.

Inflate collapsible tire only after the wheel is properly installed to the vehicle. Inflate the collapsible tire using the electric air pump before lowering the vehicle.

Do not install a wheel cover or attempt to mount a conventional tire on the collapsible spare wheel, since the wheel is designed specifically for the collapsible spare tire.

Full Size Spare — If Equipped

The full size spare is for temporary emergency use only. This tire may look like the originally equipped tire on the front or rear axle of your vehicle, but it is not. This spare tire may have limited tread life. When the tread is worn to the tread wear indicators, the temporary use full size spare tire needs to be replaced. Since it is not the same as your original equipment tire, replace (or repair) the original equipment tire and reinstall on the vehicle at the first opportunity.

NOTE:

This spare tire may not have a TPMS sensor.

Limited Use Spare — If Equipped

The limited use spare tire is for temporary emergency use only. This tire is identified by a label located on the limited use spare wheel. This label contains the driving limitations for this spare. This tire may look like the original equipped tire on the front or rear axle of your vehicle, but it is not. Installation of this limited use spare tire affects vehicle handling. Since it is not the same as your original equipment tire, replace (or repair) the original equipment tire and reinstall on the vehicle at the first opportunity.

WHEEL AND WHEEL TRIM CARE

All wheels and wheel trim, especially aluminum and chrome plated wheels, should be cleaned regularly using mild (neutral Ph) soap and water to maintain their luster and to prevent corrosion. Wash wheels with the same soap solution recommended for the body of the vehicle and remember to always wash when the surfaces are not hot to the touch.

Your wheels are susceptible to deterioration caused by salt, sodium chloride, magnesium chloride, calcium chloride, etc., and other road chemicals used to melt ice or control dust on dirt roads. Use a soft cloth or sponge and mild soap to wipe away promptly. Do not use harsh chemicals or a stiff brush. They can damage the wheel's protective coating that helps keep them from corroding and tarnishing.

CAUTION!

Avoid products or automatic car washes that use acidic solutions or strong alkaline additives or harsh brushes. Many aftermarket wheel cleaners and automatic car washes may damage the wheel's protective finish. Such damage is not covered by the New Vehicle Limited Warranty. Only car wash soap, Mopar® Wheel Cleaner or equivalent is recommended.

CAUTION!

Do not use scouring pads, steel wool, a bristle brush, metal polishes or oven cleaner. These products may damage the wheel's protective finish. Such damage is not covered by the New Vehicle Limited Warranty. Only car wash soap, Mopar® Wheel Cleaner or equivalent is recommended.

CAUTION!

If your vehicle is equipped with these specialty wheels, DO NOT USE wheel cleaners, abrasives, or polishing compounds. They will permanently damage this finish and such damage is not covered by the New Vehicle Limited Warranty. **HAND WASH ONLY USING MILD SOAP AND WATER WITH A SOFT CLOTH.** Used on a regular basis; this is all that is required to maintain this finish.

When cleaning extremely dirty wheels including excessive brake dust, care must be taken in the selection of tire and wheel cleaning chemicals and equipment to prevent damage to the wheels. Mopar® Wheel Treatment or Mopar® Chrome Cleaner or their equivalent is recommended or select a non-abrasive, non-acidic cleaner for aluminum or chrome wheels.

NOTE:

If you intend parking or storing your vehicle for an extended period after cleaning the wheels with wheel cleaner, drive your vehicle and apply the brakes to remove the water droplets from the brake components. This activity will remove the red rust on the brake rotors and prevent vehicle vibration when braking.

Dark Vapor Chrome, Black Satin Chrome, or Low Gloss Clear Coat Wheels

SNOW TRACTION DEVICES

Use of traction devices require sufficient tire-to-body clearance. Due to limited clearance the following traction devices are recommended. Follow these recommendations to guard against damage.

- Snow traction device must be of proper size for the tire, as recommended by the traction device manufacturer.
- No other tire sizes are recommended for use with a tire chain or traction device.
- Please see the following table for the recommended tire size, axle and snow traction device:

FWD Trim Level	Axle	Tire/Wheel Size	Snow Traction Device (Maximum Projection Beyond Tire Profile Or Equivalent)
All	Front	LT225/75R16E 225/75R16C	Quality Chain Corp Light Truck Highway Service (Non-Cam) tire chain or equivalent is recommended.

WARNING!

Using tires of different size and type (M+S, Snow) between front and rear axles can cause unpredictable handling. You could lose control and have a collision.

CAUTION!

To avoid damage to your vehicle or tires, observe the following precautions:

- Because of restricted traction device clearance between tires and other suspension components, it is important that only traction devices in good condition are used. Broken devices can cause serious damage. Stop the vehicle immediately if noise occurs that could indicate device breakage. Remove the damaged parts of the device before further use.
- Install device as tightly as possible and then retighten after driving about ½ mile (0.8 km). Autosock traction devices do not require retightening.
- Do not exceed 30 mph (48 km/h).
- Drive cautiously and avoid severe turns and large bumps, especially with a loaded vehicle.
- Do not drive for a prolonged period on dry pavement.
- Observe the traction device manufacturer's instructions on the method of installation, operating speed, and conditions for use. Always use the suggested operating speed of the device manufacturer's if it is less than 30 mph (48 km/h).
- Do not use traction devices on a compact spare tire.

TIRE ROTATION RECOMMENDATIONS

The tires on the front and rear of your vehicle operate at different loads and perform different steering, driving, and braking functions. For these reasons, they wear at unequal rates.

These effects can be reduced by timely rotation of tires. The benefits of rotation are especially worthwhile with aggressive tread designs such as those on all season type tires. Rotation will increase tread life, help to maintain mud, snow and wet traction levels, and contribute to a smooth, quiet ride.

Refer to the Maintenance Plan for the proper maintenance intervals ↪ page 213. The reasons for any rapid or unusual wear should be corrected prior to rotation being performed.

The suggested rotation method is the "forward cross" shown in the following diagram. This rotation pattern does not apply to some directional tires that must not be reversed.

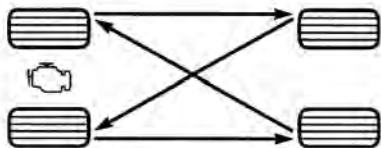

085707138

Tire Rotation (Forward Cross)

DEPARTMENT OF TRANSPORTATION UNIFORM TIRE QUALITY GRADES

The following tire grading categories were established by the National Highway Traffic Safety Administration. The specific grade rating assigned by the tire's manufacturer in each category is shown on the sidewall of the tires on your vehicle.

All passenger vehicle tires must conform to Federal safety requirements in addition to these grades.

TREADWEAR

The Treadwear grade is a comparative rating, based on the wear rate of the tire when tested under controlled conditions on a specified government test course. For example, a tire graded 150 would wear one and one-half times as well on the government course as a tire graded 100. The relative performance of tires depends upon the actual conditions of their use, however, and may depart signifi-

cantly from the norm due to variations in driving habits, service practices, and differences in road characteristics and climate.

TRACTION GRADES

The Traction grades, from highest to lowest, are AA, A, B, and C. These grades represent the tire's ability to stop on wet pavement, as measured under controlled conditions on specified government test surfaces of asphalt and concrete. A tire marked C may have poor traction performance.

WARNING!

The traction grade assigned to this tire is based on straight-ahead braking traction tests, and does not include acceleration, cornering, hydroplaning, or peak traction characteristics.

TEMPERATURE GRADES

The Temperature grades are A (the highest), B, and C, representing the tire's resistance to the generation of heat and its ability to dissipate heat, when tested under controlled conditions on a specified indoor laboratory test wheel.

Sustained high temperature can cause the material of the tire to degenerate and reduce tire life, and excessive temperature can lead to sudden tire failure. The grade C corresponds to a level of performance, which all passenger vehicle tires must meet under the Federal Motor Vehicle Safety Standard No. 109. Grades B and A represent higher levels of performance on the laboratory test wheel, than the minimum required by law.

WARNING!

The temperature grade for this tire is established for a tire that is properly inflated and not overloaded. Excessive speed, underinflation, or excessive loading, either separately or in combination, can cause heat buildup and possible tire failure.

STORING THE VEHICLE

If you are storing your vehicle for more than 3 weeks, we recommend that you take the following steps to minimize the drain on your vehicle's battery:

- Disconnect the negative cable from the battery.
- Any time you store your vehicle or keep it out of service (i.e., vacation) for two weeks or more, run the air conditioning system at idle for about five minutes in the fresh air and high blower setting prior to storing. This will ensure adequate system lubrication to minimize the possibility of compressor damage when the system is started again.

BODYWORK

PROTECTION FROM ATMOSPHERIC AGENTS

Vehicle body care requirements vary according to geographic locations and usage. Chemicals that make roads passable in snow and ice and those that are sprayed on trees and road surfaces during other seasons are highly corrosive to the metal in your vehicle. Outside parking, which exposes your vehicle to airborne contaminants, road surfaces on which the vehicle is operated, extreme hot or cold weather, and other extreme conditions will have an adverse affect on paint, metal trim, and underbody protection.

The following maintenance recommendations will enable you to obtain maximum benefit from the corrosion resistance built into your vehicle.

What Causes Corrosion?

Corrosion is the result of deterioration or removal of paint and protective coatings from your vehicle.

The most common causes are:

- Road salt, dirt and moisture accumulation
- Stone and gravel impact
- Insects, tree sap and tar
- Salt in the air near seacoast localities
- Atmospheric fallout/industrial pollutants

BODY AND UNDERBODY MAINTENANCE

Cleaning Headlights

Your vehicle is equipped with plastic headlights and fog lights that are lighter and less susceptible to stone breakage than glass headlights.

Plastic is not as scratch resistant as glass and therefore different lens cleaning procedures must be followed.

To minimize the possibility of scratching the lenses and reducing light output, avoid wiping with a dry cloth. To remove road dirt, wash with a mild soap solution followed by rinsing.

Do not use abrasive cleaning components, solvents, steel wool or other aggressive material to clean the lenses.

PRESERVING THE BODYWORK

Washing

- Wash your vehicle regularly. Always wash your vehicle in the shade using Mopar® Car Wash, or a mild car wash soap, and rinse the panels completely with water.
- If insects, tar, or other similar deposits have accumulated on your vehicle, use Mopar® Super Kleen Bug and Tar Remover to remove.
- Use a high quality cleaner wax, such as Mopar® Cleaner Wax to remove road film, stains and to protect your paint finish. Use precautions to not scratch the paint.

- Avoid using abrasive compounds and power buffing that may diminish the gloss or thin out the paint finish.

CAUTION!
<ul style="list-style-type: none"> • Do not use abrasive or strong cleaning materials such as steel wool or scouring powder that will scratch metal and painted surfaces. • Use of power washers exceeding 1,200 psi (8,274 kPa) can result in damage or removal of paint and decals.

Special Care

- If you drive on salted or dusty roads or if you drive near the ocean, hose off the undercarriage at least once a month.
- It is important that the drain holes in the lower edges of the doors, rocker panels, and trunk be kept clear and open.
- If you detect any stone chips or scratches in the paint, touch them up immediately.
- If your vehicle is damaged due to a collision or similar cause that destroys the paint and protective coating, have your vehicle repaired as soon as possible.
- If you carry special cargo such as chemicals, fertilizers, de-icer salt, etc., be sure that such materials are well packaged and sealed.
- If a lot of driving is done on gravel roads, consider mud or stone shields behind each wheel.
- Use Mopar® Touch Up Paint on scratches as soon as possible. An authorized dealer has touch up paint to match the color of your vehicle.

INTERIORS

SEATS AND FABRIC PARTS

Use Mopar® Total Clean to clean fabric upholstery and carpeting.

WARNING!

Do not use volatile solvents for cleaning purposes. Many are potentially flammable, and if used in closed areas they may cause respiratory harm.

Stain Repel Fabric Cleaning Procedure — If Equipped

Stain Repel seats may be cleaned in the following manner:

- Remove as much of the stain as possible by blotting with a clean, dry towel.
- Blot any remaining stain with a clean, damp towel.
- For tough stains, apply Mopar® Total Clean, or a mild soap solution to a clean, damp cloth and remove stain. Use a fresh, damp towel to remove soap residue.
- For grease stains, apply Mopar® Multi-Purpose Cleaner to a clean, damp cloth and remove stain. Use a fresh, damp towel to remove soap residue.
- Do not use any harsh solvents or any other form of protectants on Stain Repel products.

Seat Belt Maintenance

Do not bleach, dye or clean the belts with chemical solvents or abrasive cleaners. This will weaken the fabric.

If the belts need cleaning, use a mild soap solution or lukewarm water. Do not remove the belts from the vehicle to wash them. Dry with a soft cloth.

Sun damage can also weaken the fabric. Replace the belts if they appear frayed or worn or if the buckles do not work properly.

WARNING!

A frayed or torn seat belt could rip apart in a collision and leave you with no protection. Inspect the seat belt system periodically, checking for cuts, frays, or loose parts. Damaged parts must be replaced immediately. Do not disassemble or modify the seat belt system. If your vehicle is involved in a collision, or if you have questions regarding seat belt or retractor conditions, take your vehicle to an authorized FCA dealer or authorized FCA Certified Collision Care Program facility for inspection.

PLASTIC AND COATED PARTS

Use Mopar® Total Clean to clean vinyl upholstery.

CAUTION!

- Direct contact of air fresheners, insect repellents, suntan lotions, or hand sanitizers to the plastic, painted, or decorated surfaces of the interior may cause permanent damage. Wipe away immediately.
- Damage caused by these type of products may not be covered by your New Vehicle Limited Warranty.

Cleaning Plastic Instrument Cluster Lenses

The lenses in front of the instruments in this vehicle are molded in clear plastic. When cleaning the lenses, care must be taken to avoid scratching the plastic.

Clean with a wet soft cloth. A mild soap solution may be used, but do not use high alcohol content or abrasive cleaners. If soap is used, wipe clean with a clean damp cloth. Dry with a soft cloth.

LEATHER SURFACES

Mopar® Total Clean is specifically recommended for leather upholstery.

Your leather upholstery can be best preserved by regular cleaning with a damp soft cloth. Small particles of dirt can act as an abrasive and damage the leather upholstery and should be removed promptly with a damp cloth. Stubborn soils can be removed easily with a soft cloth and Mopar® Total Clean. Care should be taken to avoid soaking your leather upholstery with any liquid. Please do not use polishes, oils, cleaning fluids, solvents, detergents, or ammonia-based cleaners to clean your leather upholstery.

NOTE:

If equipped with light colored leather, it tends to show any foreign material, dirt, and fabric dye transfer more so than darker colors. The leather is designed for easy cleaning, and FCA recommends Mopar® total care leather cleaner applied on a cloth to clean the leather seats as needed.

CAUTION!

Do not use alcohol and alcohol-based and/or ketone-based cleaning products to clean leather upholstery, as damage to the upholstery may result.

GLASS SURFACES

All glass surfaces should be cleaned on a regular basis with Mopar® Glass Cleaner, or any commercial household-type glass cleaner. Never use an abrasive type cleaner. Use caution when cleaning the inside rear window equipped with electric defrosters or windows equipped with radio antennas. Do not use scrapers or other sharp instruments that may scratch the elements.

When cleaning the rearview mirror, spray cleaner on the towel or cloth that you are using. Do not spray cleaner directly on the mirror.

TECHNICAL SPECIFICATIONS

VEHICLE IDENTIFICATION NUMBER (VIN)

The VIN is found on the left front corner of the instrument panel, visible through the windshield.

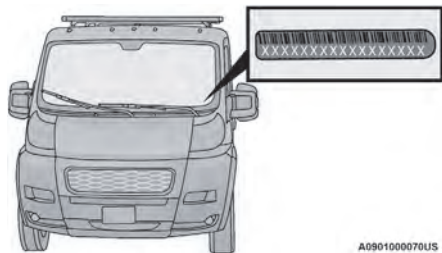

Vehicle Identification Number

NOTE:

It is illegal to remove or alter the VIN.

BRAKE SYSTEM

Your vehicle is equipped with dual hydraulic brake systems. If either of the two hydraulic systems lose normal capability, the remaining system will still function. However, there will be some loss of overall braking effectiveness. You may notice increased pedal travel during application, greater pedal force required to slow or stop, and potential activation of the Brake System Warning Light.

In the event power assist is lost for any reason (i.e., repeated brake applications with the engine off), the brakes will still function. However, the effort required to brake the vehicle will be much greater than that required with the power system operating.

CAUTION!

If the Brake System Warning Light remains on with the parking brake released, a brake system malfunction is indicated. Have the brake system serviced by an authorized dealer immediately.

WHEEL AND TIRE TORQUE SPECIFICATIONS

Proper lug nut/bolt torque is very important to ensure that the wheel is properly mounted to the vehicle. Any time a wheel has been removed and reinstalled on the vehicle, the lug nuts/bolts should be torqued using a properly calibrated torque wrench using a six-sided (hex) deep wall socket.

TORQUE SPECIFICATIONS

Lug Nut/Bolt Torque	**Lug Nut/Bolt Size	Lug Nut/Bolt Socket Size
145 ft-lb (197 N-m)	M16 x 1.50	21 mm

**Use only authorized dealer recommended lug nuts/bolts and clean or remove any dirt or oil before tightening.

Inspect the wheel mounting surface prior to mounting the tire and remove any corrosion or loose particles.

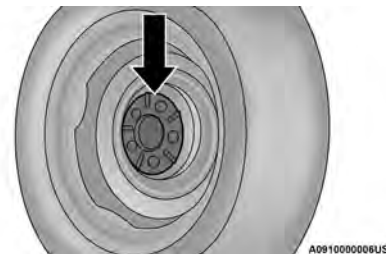

Wheel Mounting Surface

Tighten the lug nuts/bolts in a star pattern until each nut/bolt has been tightened twice. Ensure that the socket is fully engaged on the lug nut/bolt (do not insert it halfway).

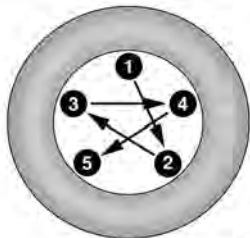

A0810000004US

Torque Patterns

After 25 miles (40 km), check the lug nut/bolt torque to be sure that all the lug nuts/bolts are properly seated against the wheel.

WARNING!

To avoid the risk of forcing the vehicle off the jack, do not tighten the lug nuts/bolts fully until the vehicle has been lowered. Failure to follow this warning may result in personal injury.

FUEL REQUIREMENTS

While operating on gasoline with the required octane number, hearing a light knocking sound from the engine is not a cause for concern. However, if the engine is heard making a heavy knocking sound, see a dealer immedi-

ately. Use of gasoline with a lower than recommended octane number can cause engine failure and may void or not be covered by the New Vehicle Limited Warranty.

Poor quality gasoline can cause problems such as hard starting, stalling, and hesitations. If you experience these symptoms, try another brand of gasoline before considering service for the vehicle.

3.6L ENGINE



This engine is designed to meet all emission regulations and provide optimum fuel economy and performance when using high quality unleaded regular gasoline having a posted octane number of 87 as specified by the (R+M)/2 method. The use of higher octane premium gasoline is not required, as it will not provide any benefit over regular gasoline in these engines.

REFORMULATED GASOLINE

Many areas of the country require the use of cleaner-burning gasoline referred to as "reformulated gasoline". Reformulated gasoline contains oxygenates and are specifically blended to reduce vehicle emissions and improve air quality.

The use of reformulated gasoline is recommended. Properly blended reformulated gasoline will provide improved performance and durability of engine and fuel system components.

MATERIALS ADDED TO FUEL

Besides using unleaded gasoline with the proper octane rating, gasolines that contain detergents, corrosion and stability additives are recommended. Using gasolines that have these additives will help improve fuel economy, reduce emissions, and maintain vehicle performance.



Designated TOP TIER Detergent Gasoline contains a higher level of detergents to further aide in minimizing engine and fuel system deposits. When available, the usage of TOP TIER Detergent gasoline is recommended. Visit www.toptiergas.com for a list of TOP TIER Detergent Gasoline retailers.

Indiscriminate use of fuel system cleaning agents should be avoided. Many of these materials intended for gum and varnish removal may contain active solvents or similar ingredients. These can harm fuel system gasket and diaphragm materials.

GASOLINE/OXYGENATE BLENDS

Some fuel suppliers blend unleaded gasoline with oxygenates such as ethanol.

CAUTION!

DO NOT use E-85, gasoline containing methanol, or gasoline containing more than 15% ethanol (E-15). Use of these blends may result in starting and drivability problems, damage critical fuel system components, cause emissions to exceed the applicable standard, and/or cause the Malfunction Indicator Light to illuminate. Please observe pump labels as they should clearly communicate if a fuel contains greater than 15% ethanol (E-15).

Problems that result from using gasoline containing more than 15% ethanol (E-15) or gasoline containing methanol are not the responsibility of the manufacturer and may void or not be covered under New Vehicle Limited Warranty.

DO NOT USE E-85 IN NON-FLEX FUEL VEHICLES

Non-Flex Fuel Vehicles (FFV) are compatible with gasoline containing up to 15% ethanol (E-15). Use of gasoline with higher ethanol content may void the New Vehicle Limited Warranty.

If a Non-FFV vehicle is inadvertently fueled with E-85 fuel, the engine will have some or all of these symptoms:

- Operate in a lean mode.
- OBD II Malfunction Indicator Light on.
- Poor engine performance.
- Poor cold start and cold drivability.
- Increased risk for fuel system component corrosion.

CNG AND LP FUEL SYSTEM MODIFICATIONS

Modifications that allow the engine to run on Compressed Natural Gas (CNG) or Liquid Propane (LP) may result in damage to the engine, emissions, and fuel system components. Problems that result from running CNG or LP are not the responsibility of the manufacturer and may void or not be covered under the New Vehicle Limited Warranty.

MMT IN GASOLINE

Methylcyclopentadienyl Manganese Tricarbonyl (MMT) is a manganese-containing metallic additive that is blended into some gasolines to increase octane. Gasoline blended with MMT provides no performance advantage beyond gasoline of the same octane number without MMT. Gasoline blended with MMT reduces spark plug life and reduces emissions system performance in some vehicles. The manufacturer recommends that gasoline without MMT be used in your vehicle. The MMT content of gasoline may not be indicated on the gasoline pump; therefore, you should ask your gasoline retailer whether the gasoline contains MMT. MMT is prohibited in Federal and California reformulated gasoline.

FUEL SYSTEM CAUTIONS

CAUTION!
<p>Follow these guidelines to maintain your vehicle's performance:</p> <ul style="list-style-type: none"> • The use of leaded gasoline is prohibited by Federal law. Using leaded gasoline can impair engine performance and damage the emissions control system. • An out-of-tune engine or certain fuel or ignition malfunctions can cause the catalytic converter to overheat. If you notice a pungent burning odor or some light smoke, your engine may be out of tune or malfunctioning and may require immediate service. Contact an authorized dealer for service assistance. • The use of fuel additives, which are now being sold as octane enhancers, is not recommended. Most of these products contain high concentrations of

(Continued)

CAUTION!
<p>methanol. Fuel system damage or vehicle performance problems resulting from the use of such fuels or additives is not the responsibility of the manufacturer and may void or not be covered under the New Vehicle Limited Warranty.</p>

NOTE:

Intentional tampering with the emissions control system can result in civil penalties being assessed against you.

FLUID CAPACITIES

	US	Metric
Fuel (Approximate)		
3.6L Engine	24 gal	90 L
Engine Oil With Filter		
3.6L Engine	6 qt	5.6 L
Cooling System		
3.6L Engine	12.6 qt	11.9 L

FLUID CAPACITIES — BEV (IF EQUIPPED)

Systems		U.S.	Metric
Engine Cooling System	Cabin Heater loop	2.7 qt	2.6 L
	Electric Motor / Battery loop	13.8 qt	13.1 L
EDU (Electric Drive Unit)		1.6 qt	1.5 L
Hydraulic Brake System		0.65 qt	0.62 L
Washer Fluid		5.8 qt	5.5 L

ENGINE FLUIDS AND LUBRICANTS

Component	Fluid, Lubricant, or Genuine Part
Engine Coolant	We recommend using Mopar® Antifreeze/Coolant 10 Year/150,000 Mile (240,000 km) Formula OAT (Organic Additive Technology) meeting the requirements of the manufacturer Material Standard MS.90032.
Engine Oil	We recommend using Mopar® SAE OW-20 Full Synthetic Engine Oil which meets the requirements of the manufacturer Material Standard MS-6395. Equivalent full synthetic SAE OW-20 engine oil can be used but must have the API Starburst trademark ↪ page 220.
Fuel Selection	87 Octane (R+M)/2 Method, 0-15% Ethanol.

CAUTION!

- Mixing of engine coolant (antifreeze) other than specified Organic Additive Technology (OAT) engine coolant (antifreeze), may result in engine damage and may decrease corrosion protection. Organic Additive Technology (OAT) engine coolant is different and should not be mixed with Hybrid Organic Additive Technology (HOAT) engine coolant (antifreeze) or any “globally compatible” coolant (antifreeze). If a non-OAT engine coolant (antifreeze) is

(Continued)

CAUTION!

introduced into the cooling system in an emergency, the cooling system will need to be drained, flushed, and refilled with fresh OAT coolant (conforming to MS.90032), by an authorized dealer as soon as possible.

(Continued)

CAUTION!

- Do not use water alone or alcohol-based engine coolant (antifreeze) products. Do not use additional rust inhibitors or antirust products, as they may not be compatible with the radiator engine coolant and may plug the radiator.
- This vehicle has not been designed for use with propylene glycol-based engine coolant (antifreeze). Use of propylene glycol-based engine coolant (antifreeze) is not recommended.

CHASSIS FLUIDS AND LUBRICANTS

Component	Fluid, Lubricant, Or Genuine Part
Automatic Transmission	Use only Mopar® ZF 8 & 9 Speed ATF Automatic Transmission Fluid or equivalent. Failure to use the correct fluid may affect the function or performance of your transmission.
Brake Master Cylinder	We recommend using Mopar® DOT 4. DOT 4 brake fluid must be changed every two years regardless of mileage.

CUSTOMER ASSISTANCE

SUGGESTIONS FOR OBTAINING SERVICE FOR YOUR VEHICLE

PREPARE FOR THE APPOINTMENT

All work to be performed may not be covered by the warranty. Discuss additional charges with the service manager. Keep a maintenance log of your vehicle's service history. This can often provide a clue to the current problem.

PREPARE A LIST

Make a written list of your vehicle's problems or the specific work you want done. If you've had an accident or work done that is not on your maintenance log, let the service advisor know.

BE REASONABLE WITH REQUESTS

If you list a number of items and you must have your vehicle by the end of the day, discuss the situation with the service advisor and list the items in order of priority. At many authorized dealers, you may obtain a rental vehicle (additional charges may apply). If you need a rental, it is advisable to make these arrangements when you call for an appointment.

IF YOU NEED ASSISTANCE

FCA US LLC and its authorized dealers are vitally interested in your satisfaction. We want you to be happy with our products and services.

Warranty service must be done by an authorized dealer. We strongly recommend that you take the vehicle to an authorized dealer. They know your vehicle the best, and are most concerned that you get prompt and high quality service. FCA US LLC's authorized dealers have the facilities, factory-trained technicians, special tools, and the latest information to ensure the vehicle is fixed correctly and in a timely manner.

This is why you should always talk to an authorized dealer's service manager first. If for some reason you are still not satisfied, talk to the general manager or owner of the authorized dealer. They want to know if you need assistance. If an authorized dealer is unable to resolve the concern, you may contact FCA US LLC's Customer Assistance center.

Any communication to FCA US LLC's customer center should include the following information:

- Owner's name and address
- Owner's telephone number (home, mobile, and office)
- Authorized dealer name
- Vehicle Identification Number (VIN)
- Vehicle delivery date and mileage

ROADSIDE ASSISTANCE

Available 24 hours, 7 days a week.

Call 1-800-521-2779 or visit chrysler.rsahelp.com(USA)

Call 1-800-363-4869 or visit fca.roadsideaid.com (Canada)

Who is Covered

You are covered by Roadside Assistance services if you are a purchaser for use of the vehicle. Roadside Assistance services last for five years or 60,000 miles on the odometer, whichever occurs first, calculated from the start date of the Basic Limited Warranty, as set forth in your Warranty Information book.¹

1. Towing services provided through Cross Country Motor Club, Inc.

Medford, MA 02155, except in AK, CA, HI, OR, WI, and WY, where services are provided by Cross Country Motor Club of California, Inc., Thousand Oaks, CA 91360.

What to Do

If your vehicle requires jump start assistance, out of gas/fuel delivery, tire service, lockout service or towing as a result of a mechanical breakdown, dial toll-free: USA: 1-800-521-2779/Canada: 1-800-363-4869. Provide your name, Vehicle Identification Number (VIN) required for covered services, license plate number, and your location, including the telephone number from which you are calling. Briefly describe the nature of the problem and answer a few simple questions. You will be given the name of the service provider and an estimated time of arrival. If you feel you are in an unsafe situation, please let us know. With your consent, we will contact local police or safety authorities.

If Unable to Contact Roadside Assistance (Gas engine only)

If you are unable to contact Roadside Assistance or unable to provide a valid Vehicle Identification Number (VIN), and you obtain towing services on your own, you may submit your original receipts from the licensed towing or service facility, for services rendered within

30 days of the occurrence. Be sure to include your VIN, odometer mileage at the time of service, and current mailing address. We will process the claim based on vehicle and service eligibility. If eligible, we will reimburse you for the reasonable amount actually paid, based on the usual and customary charges for that service in the area where they were provided. FCA US LLC's determination relating to reimbursement is final. Correspondence should be mailed to:

FCA US LLC Customer Assistance

P.O. Box 9145

Medford, MA 02155

Attention Claims Department

FCA US LLC reserves the right to modify the terms or discontinue the Roadside Assistance Program at any time. The Roadside Assistance program is subject to restrictions and conditions of use, which are determined solely by FCA US LLC.

Flat Tire Service

If you are inconvenienced by a flat tire, we will dispatch a service provider to use your vehicle's temporary spare tire (if equipped) as recommended in your Owner's Manual. This is not a permanent flat tire repair.

Out of Gas/Fuel Delivery

Drivers cannot always count on a gas station being nearby, especially when traveling away from home. We will dispatch a service provider to deliver a small amount of fuel (maximum two gallons) to get you to a nearby station. This service is limited to two occurrences in a 12-month period.

Battery Jump Assistance

No time is a good time for a depleted battery. With Roadside Assistance, you do not have to worry about being stranded. We will dispatch a service provider to provide you with a battery jump anytime, day or night.

Lockout Service

Whether the keys are locked in your vehicle or frozen locks are keeping you from getting on your way, help is just a phone call away. This service is limited to providing access to the vehicle's seating area. It does not cover the cost of replacement keys.

Towing Service

Our towing service gives you peace of mind and confidence. If your vehicle becomes disabled as a result of a mechanical breakdown, Roadside Assistance will dispatch a towing service to transport your vehicle to the closest authorized Chrysler, Dodge, Jeep®, or Ram dealer. If you choose to go to another dealer, you will be responsible for the cost of the extra distance.

FCA US LLC CUSTOMER CENTER

P.O. Box 21-8004

Auburn Hills, MI 48321-8004

Phone: (866) 726-4636

FCA CANADA CUSTOMER CARE

P.O. Box 1621

Windsor, Ontario N9A 4H6

Phone: (800) 465-2001 English / (800) 387-9983 French

MEXICO

Av. Prolongacion Paseo de la Reforma, 1240

Sante Fe C.P. 05109

Mexico, CDMX

In Mexico City: 800-505-1300

Outside Mexico City: +(52) 55 50817568

PUERTO RICO AND US VIRGIN ISLANDS

FCA Caribbean LLC

P.O. Box 191857

San Juan 00919-1857

Phone: (866) 726-4636

CUSTOMER ASSISTANCE FOR THE HEARING OR SPEECH IMPAIRED (TDD/TTY)

To assist customers who have hearing difficulties, FCA US LLC has installed special Telecommunication Devices for the Deaf (TDD) equipment at its customer center. Any hearing or speech impaired customer, who has access to a TDD or a conventional teletypewriter (TTY) in the United States, can communicate with FCA US LLC by dialing 1-800-380-2479.

Canadian residents with hearing difficulties that require assistance can use the special needs relay service offered by Bell Canada. For TTY teletypewriter users, dial 711 and for Voice callers, dial 1-800-855-0511 to connect with a Bell Relay Service operator.

SERVICE CONTRACT

You may have purchased a service contract for a vehicle to help protect you from the high cost of unexpected repairs after FCA US LLC's New Vehicle Limited Warranty expires. The Mopar® Vehicle Protection plans are the ONLY vehicle extended protection plans authorized, endorsed and backed by FCA US LLC to provide additional protection beyond your vehicle's warranty. If you purchased a Mopar® Vehicle Protection Plan, you will receive Plan Provisions and an Owner Identification

Card in the mail within three weeks of the vehicle delivery date. If you have any questions about the service contract, call FCA US LLC's Service Contract National Customer Hotline at 1-800-521-9922.

For Canadian residents, you may have purchased additional coverage with an extended service contract. FCA Canada Inc. stands fully behind its service contracts. Be sure that the one you buy is a genuine Canada Inc. service contract. We are not responsible for other companies' contracts. If you purchased a contract other than a genuine FCA Canada Inc. service contract and you have a problem, you will have to contact the administrator of that contract for resolution. If you have any questions about the service contract, call the FCA's Service Contract National Customer Hotline at (800) 465-2001 English / (800) 387-9983 French).

Mopar Vehicle Protection Plans offer valuable protection against repair costs after your vehicle warranties have expired. Mopar Vehicle Protection plans are the ONLY vehicle extended protection plans authorized, endorsed and backed by FCA US LLC to provide additional protection beyond your vehicle's warranty.

FCA US LLC is not responsible for any service contract you may have purchased from another manufacturer. If you require service after the FCA US LLC New Vehicle Limited Warranty expires, please refer to the contract documents, and contact the person listed in those documents.

We appreciate that you have made a major investment when you purchased the vehicle. An authorized dealer has also made a major investment in facilities, tools, and training to assure that you are absolutely delighted with the ownership experience.

Warranty Information

See the Warranty Information for the terms and provisions of FCA US LLC warranties applicable to this vehicle and market. Refer to www.mopar.com/om for further information.

See the Warranty Information for the terms and provisions of FCA Canada Inc. warranties applicable to this vehicle and market. Refer to www.owners.mopar.ca/en for further information.

For French, refer to www.owners.mopar.ca/fr for further information.

Use this QR code to access your digital experience.



MOPAR® PARTS

Mopar® original equipment parts and accessories and factory filled fluids are available from an authorized dealer. They are recommended for your vehicle to keep it operating at its best and maintain its original condition.

REPORTING SAFETY DEFECTS

IN THE 50 UNITED STATES AND WASHINGTON, D.C.

If you believe that your vehicle has a defect that could cause a crash or

cause injury or death, you should immediately inform the National Highway Traffic Safety Administration (NHTSA) in addition to notifying FCA US LLC.

If NHTSA receives similar complaints, it may open an investigation, and if it finds that a safety defect exists in a group of vehicles, it may order a recall and remedy campaign. However, NHTSA cannot become involved in individual problems between you, an authorized dealer, or FCA US LLC.

To contact NHTSA, you may call the Vehicle Safety Hotline toll free at 1-888-327-4236 (TTY: 1-800-424-9153); or go to <http://www.safercar.gov>; or write to: Administrator, NHTSA, 1200 New Jersey Avenue, SE., West Building, Washington, D.C. 20590. You can also obtain other information about motor vehicle safety from <http://www.safercar.gov>.

IN CANADA

If you believe that your vehicle has a safety defect, you should contact the Customer Service Department immediately. Canadian customers who wish to report a safety defect to the Canadian government should contact Transport Canada, Motor Vehicle Defect Investigations and Recalls at 1-800-333-0510 or go to wwwapps.tc.gc.ca/Saf-Sec-Sur/7/PCDB-BDPP.

ORDERING AND ACCESSING ADDITIONAL OWNER'S INFORMATION

To order the following manuals, you may use either the website or the phone numbers listed below.

Service Manuals

These comprehensive Service Manuals provide a complete working knowledge of the vehicle, system, and/or components and is written in straightforward language with illustrations, diagrams, and charts.

Diagnostic Procedure Manuals

Diagnostic Procedure Manuals are filled with diagrams, charts and detailed illustrations. These manuals make it easy to find and fix problems on computer-controlled vehicle systems and features. They show exactly how to

find and correct problems, using step-by-step troubleshooting and drivability procedures, proven diagnostic tests and a complete list of all tools and equipment.

To order a digital copy of your Service or Diagnostic Procedure manuals, visit:

www.techauthority.com (US and Canada).

Owner's Manuals

These Owner's Manuals have been prepared with the assistance of service and engineering specialists to acquaint you with specific FCA vehicles.

To access your Owner's Information online, visit www.mopar.com/om (US) or www.owners.mopar.ca (Canada).

Or visit:

www.techauthority.com to order physical copies of Owner's Manuals (US).

Owner's Manuals, Radio Manuals and Warranty Information Books can be ordered through Archway at:

- 1-800-387-1143 (Canada)

CHANGE OF OWNERSHIP OR ADDRESS

*If you have purchased this vehicle used or have changed your address, please provide the following information and mail to:

FCA US LLC

P.O. Box 21-8008

Auburn Hills, MI 48321-8004

Make sure to include the following:

- Date of Sale (mm/dd/yy)
- Vehicle Identification Number (17 Character ID located on top left of the instrument panel)
- Exact Odometer Reading

- First and Last Name
- Phone Number
- Street Address, City, State and Zip Code
- Email Address

*Applies to US residents only.

GENERAL INFORMATION

Keyless Enter 'n Go

The following regulatory statement applies to Keyless Enter 'n Go devices equipped in this vehicle:

US

Start Button FCC ID: A2C81227100

Key FCC ID: S180227006

RFHM ECU FCC ID: M3N-82135300

These devices comply with Part 15 of the FCC Rules. Operation is subject to the following two conditions: (1) This device may not cause harmful interference, and (2) This device must accept any interference received, including interference that may cause undesired operation.

MEXICO

La operación de este equipo está sujeta a las siguientes dos condiciones:

1. Es posible que este equipo o dispositivo no cause interferencia perjudicial y
2. Este equipo o dispositivo debe aceptar cualquier interferencia, incluyendo la que pueda causar su operación no deseada.

UConnect

The following regulatory statement applies to UConnect devices equipped in this vehicle:

FCC ID: Y70VP2REFRESH

IC: 7812H-VP2REFRESH

Blind Spot Monitoring Systems

The following regulatory statements apply to Blind Spot Monitoring System:

MEXICO

IFETEL: RLVCSR15-0904

La operación de este equipo está sujeta a las siguientes dos condiciones:

1. Es posible que este equipo o dispositivo no cause interferencia perjudicial y
2. Este equipo o dispositivo debe aceptar cualquier interferencia, incluyendo la que pueda causar su operación no deseada.

US

FCC ID OAYSRR3B

These devices comply with Part 15 of the FCC Rules. Operation is subject to the following two conditions:

1. This device may not cause harmful interference, and
2. This device must accept any interference received, including interference that may cause undesired operation.

CAUTION TO USERS

Changes or modifications not expressly approved by the party responsible for compliance could void the user's authority to operate the equipment.

CANADA

ISED Cert Numb: 4135A-SRR3B

This device contains licence-exempt transmitter(s)/ receiver(s) that comply with Innovation, Science and Economic Development Canada's licence-exempt RSS(s). Operation is subject to the following two conditions:

1. This device may not cause interference.
2. This device must accept any interference, including interference that may cause undesired operation of the device.

Radio frequency radiation exposure information:

This equipment complies with radiation exposure limits set forth for an uncontrolled environment. This equipment should be installed and operated with minimum distance of 20 cm between the radiator and your body. L'émetteur/récepteur exempt de licence contenu dans le présent appareil est conforme aux CNR d'Innovation, Sciences et Développement économique Canada applicables aux appareils radio exempts de licence. L'exploitation est autorisée aux deux conditions suivantes:

1. L'appareil ne doit pas produire de brouillage;
2. L'appareil doit accepter tout brouillage radioélectrique subi, même si le brouillage est susceptible d'en compromettre le fonctionnement.

Informations sur l'exposition aux rayonnements radiofréquences:

Cet équipement est conforme aux limites d'exposition aux rayonnements définies pour un environnement non contrôlé. Cet équipement doit être installé et utilisé avec un minimum de 20 cm de distance entre la source de rayonnement et votre corps.

Medium Range Radar

The following regulatory statements apply to Medium Range Radar:

MEXICO

IFETEL: RCPBOMR17-0598

La operación de este equipo está sujeta a las siguientes dos condiciones:

1. Es posible que este equipo o dispositivo no cause interferencia perjudicial y
2. Este equipo o dispositivo debe aceptar cualquier interferencia, incluyendo la que pueda causar su operación no deseada.

US

FCC ID NF3-MRREVO14F

These devices comply with Part 15 of the FCC Rules. Operation is subject to the following two conditions:

1. This device may not cause harmful interference, and
2. This device must accept any interference received, including interference that may cause undesired operation.

Changes or modifications made to this equipment not expressly approved by Robert BOSCH GmbH may void the FCC authorization to operate this equipment.

This equipment has been tested and found to comply with the limits for a Class A digital device, pursuant to Part 15 of the FCC Rules. These limits are designed to provide reasonable protection against harmful interference when the equipment is operated in a commercial environment. This equipment generates, uses, and can radiate radio frequency energy and, if not installed and used in accordance with the instruction manual, may cause harmful interference to radio communications. Operation of this equipment in a residential area is

likely to cause harmful interference in which case the user will be required to correct the interference at his own expense. RF Exposure Information according 2.1091 / 2.1093 / KDB 447498 / OET bulletin 65: Radio frequency radiation exposure Information: This equipment complies with FCC radiation exposure limits set forth for an uncontrolled environment. This equipment should be installed and operated with minimum distance of 20 cm between the radiator and your body. This transmitter must not be co-located or operating in conjunction with any other antenna or transmitter.

CANADA

ISED Cert Numb: 3887A-MRRE14FCR

This device complies with Industry Canada license-exempt RSS standard(s). Operation is subject to the following two conditions:

1. This device must not cause interference, and
2. This device must accept any interference, including interference that may cause undesired operation of the device.

L'émetteur/récepteur exempt de licence contenu dans le présent appareil est conforme aux CNR d'Innovation, Sciences et Développement économique Canada applicables aux appareils radio exempts de licence. L'exploitation est autorisée aux deux conditions suivantes:

1. L'appareil ne doit pas produire de brouillage;
2. L'appareil doit accepter tout brouillage radioélectrique subi, même si le brouillage est susceptible d'en compromettre le fonctionnement.

RF Exposure Information according to RSS-102

Radio frequency radiation exposure Information:

This equipment complies with FCC and IC radiation exposure limits set forth for an uncontrolled environment. This equipment should be installed and operated with minimum distance of 20 cm between the radiator and your body. This transmitter must not be co-located or operating in conjunction with any other antenna or transmitter.

Cet équipement est conforme aux limites d'exposition aux rayonnements IC établies pour un environnement non contrôlé. Cet équipement doit être installé et utilisé avec un minimum de 20 cm de distance entre la source de rayonnement et votre corps. Ce transmetteur ne doit pas être placé au même endroit ou utilisé simultanément avec un autre transmetteur ou antenne.

INDEX

A

Active Driving Assist107
Active Speed Limiter98
Adaptive Cruise Control (ACC) (Cruise Control)99
Adding Engine Coolant (Antifreeze)224
Adding Washing Fluid217
Additives, Fuel262
Air Bag172
Air Bag Operation172
Air Bag Warning Light171
Enhanced Accident Response175, 212
Event Data Recorder (EDR)212
If Deployment Occurs175
Maintaining Your Air Bag System176
Maintenance176
Side Air Bags173
Transporting Pets183
Air Bag Light77, 171, 184
Air Cleaner, Engine (Engine Air Cleaner Filter)220, 221
Air Conditioner Maintenance221
Air Conditioner Refrigerant221, 222
Air Conditioner System221
Air Conditioning Filter57, 222
Air Conditioning, Operating Tips56, 57
Air Filter220
Air Pressure	
Tires250
Alarm	
Security Alarm34, 80
Alarm System	
Security Alarm34
Alterations/Modifications	
Vehicle8

Antifreeze (Engine Coolant)224, 264
Disposal225
Anti-Lock Brake System (ABS)151
Anti-Lock Warning Light80
Assist, Hill Start154
Audio Systems (Radio)136
Auto Down Power Windows61
Automatic Headlights48
Automatic High Beams48
Automatic Transmission91, 227
Adding Fluid227
Fluid And Filter Change227
Fluid Change227
Fluid Level Check227
Fluid Type227, 265
Special Additives227
Auto Up Power Windows61
AUX Cord58
Auxiliary Driving Systems155

B

Base / Midline Instrument Cluster 65
Battery14, 78, 217
Charging16
Charging System Light78
Keyless Key Fob Replacement27
Belts, Seat183
Blind Spot Monitoring155
Body Builders Guide8
Body Mechanism Lubrication222
B-Pillar Location247
Brake Assist System152
Brake Control System, Electronic152

Brake Fluid226, 265
Brake System226, 261
Anti-Lock (ABS)151
Fluid Check226
Master Cylinder226
Parking89
Warning Light77
Brake/Transmission Interlock92
Bulb Replacement240
Bulbs, Light185, 240

C

Camera, Rear123, 124
Capacities, Fluid264
Caps, Filler	
Fuel126
Oil (Engine)216
Radiator (Coolant Pressure)225
Carbon Monoxide Warning185
Cargo Area Cover63
Cargo Compartment63
Cargo Light50
Car Washes258
Cellular Phone150
Certification Label127
Change Engine Oil If Equipped 71
Change Oil Indicator71
Changing A Flat Tire189
Charging16
Chart, Tire Sizing245
Check Engine Light (Malfunction Indicator Light)85
Checking Your Vehicle For Safety183

- Checks, Safety183
 Child Restraint177
 Child Restraints
 Booster Seats178
 Child Seat Installation180
 Infant And Child Restraints178
 Older Children And Child Restraints178
 Clean Air Gasoline262
 Cleaning
 Wheels254
 Climate Control54
 Manual54
 Rear56
 Cold Weather Operation87
 Compact Spare Tire253
 Contract, Service267
 Cooling Pressure Cap (Radiator Cap)225
 Cooling System224
 Adding Coolant (Antifreeze)224
 Coolant Level224, 225
 Cooling Capacity264
 Disposal Of Used Coolant225
 Drain, Flush, And Refill224
 Inspection225
 Points To Remember226
 Pressure Cap225
 Radiator Cap225
 Selection Of Coolant (Antifreeze)224, 264, 265
 Corrosion Protection258
 Cruise Light84
 Customer Assistance266
 Customer Programmable Features136
 Cybersecurity136
- D**
 Dealer Service220
 Defroster, Windshield184
 Diagnostic System, Onboard85
 Dimmer Control Switch51
 Dimmer Switch
 Headlight48
 Dipsticks
 Automatic Transmission227
 Oil (Engine)217
 Disable Vehicle Towing209
 Disposal
 Antifreeze (Engine Coolant)225
 Door Ajar78
 Door Ajar Light78
 Door Locks35, 37
 Doors35
 Driver's Seat Back Tilt39
 Driving
 Through Flowing, Rising, Or Shallow Standing
 Water134
 Drowsy Driver Detection160
- E**
 Electrical Power Outlets58
 Electric Brake Control System152
 Electric Parking Brake89
 Electric Remote Mirrors46
 Electronic Stability Control (ESC)153
 Electronic Throttle Control Warning Light78
 Emergency Braking163
 Emergency, In Case Of
 Freeing Vehicle When Stuck208
 Jacking189
 Jump Starting203, 205
 Emission Control System Maintenance85
- Engine216
 Air Cleaner220
 Block Heater88
 Break-In Recommendations89
 Checking Oil Level217
 Compartment216, 219
 Compartment Identification216, 219
 Coolant (Antifreeze)224, 265
 Cooling224
 Exhaust Gas Caution185
 Fails To Start87
 Flooded, Starting87
 Fuel Requirements262, 264
 Jump Starting203, 205
 Oil220, 264, 265
 Oil Filler Cap216
 Oil Filter220
 Oil Selection220, 264
 Oil Synthetic220
 Overheating207
 Starting87, 88
 Enhanced Accident Response Feature175, 212
 Entry System, Illuminated52
 Ethanol262
 Exhaust Gas Cautions185
 Exhaust System185, 223
 Exterior Lights47, 185
- F**
 Filters
 Air Cleaner220
 Air Conditioning57, 222
 Engine Oil220
 Engine Oil Disposal220
 Flashers
 Hazard Warning186

Turn Signals185
Flat Tire Changing244, 253
Flat Tire Stowage244, 253
Flooded Engine Starting87
Fluid Capacities264
Fluid Leaks185
Fluid Level Checks	
Automatic Transmission227
Brake226
Cooling System224
Engine Oil217
Fog Lights49
Fold-Flat Seats39
Forward Collision Warning160
Four-Way Hazard Flasher186
Freeing A Stuck Vehicle208
Fuel262
Additives262
Clean Air262
Ethanol262
Filler Cap (Gas Cap)126
Gasoline262
Materials Added262
Methanol262
Octane Rating262, 265
Requirements262, 264
Tank Capacity264
Fuses227
G	
Gas Cap (Fuel Filler Cap)126, 127
Gasoline, Clean Air262
Gasoline, Reformulated262
Gauges	
Fuel81
Gear Ranges92

Gear Selector Override208
Glass Cleaning260
Gross Axle Weight Rating127, 128
Gross Vehicle Weight Rating127, 128
Guide	
Body Builders8
GVWR127

H

Hazard	
Driving Through Flowing, Rising, Or Shallow Standing Water134
Hazard Warning Flashers186
Headlights	
Automatic48
Cleaning258
High Beam48
High Beam/Low Beam Select Switch48
On With Wipers49
Passing48
Switch47
Headlights 48
Head Restraints43
Heated Mirrors47
Heated Seats41
Heater, Engine Block88
High Beam/Low Beam Select (Dimmer) Switch48
High Voltage Battery14
Hill Start Assist154
Hitches	
Trailer Towing129
Hood Prop62
Hood Release62

I

Ignition29
Switch29
Illuminated Entry52
Immobilizer (Sentry Key)28
Inside Rearview Mirror45, 186
Instrument Cluster68
Descriptions67, 69
Display69
Display Controls69
Menu Items71
Instrument Panel Lens Cleaning259
Intelligent Speed Assist98
Interior And Instrument Lights50
Interior Appearance Care259
Interior Lights50
Intermittent Wipers (Delay Wipers)52
Inverter	
Power59
iPod/USB/MP3 Control58

J

Jacking And Tire Changing189
Jacking And Tire Changing 189
Jacking And Tire Changing Instructions189
Jack Location189
Jack Operation189
Jump Starting203, 205

K

Key Fob26
Programming Additional Key Fobs28
Key Fob Battery Service (Remote Keyless Entry)27
Key Fob Programming (Remote Keyless Entry)28

- Keyless Enter-N-Go36
 Passive Entry36
 Keys26
 Replacement28
 Sentry (Immobilizer)28
- L**
- Lane Change Assist50
 LaneSense121
 Lap/Shoulder Belts167
 Latches185
 Hood62
 Lead Free Gasoline262
 Leaks, Fluid185
 Life Of Tires252
 Light Bulbs185, 240
 Lights185
 Air Bag77, 171, 184
 Audio System80
 Brake Assist Warning153
 Brake Warning77
 Bulb Replacement240
 Collision Warning81, 83
 Cruise84
 Daytime Running48
 Dimmer Switch, Headlight47, 48
 Electronic Stability Program
 (ESP) Indicator78, 80, 153
 Exterior47, 185
 Fuel Cutoff Failure83
 Hazard Warning Flasher186
 Headlights47
 High Beam48
 Illuminated Entry52
 Instrument Cluster79
 Interior50
- Malfunction Indicator (Check Engine)81
 Park49, 84
 Passing48
 Plug Status84
 Plug Status Fault79
 Rear Cargo Door Open Warning Light79
 Seat Belt Reminder79
 Security Alarm80
 Service240
 Tire Pressure Monitoring (TPMS)164
 Torque Limited79
 Tow Haul83
 TowingHookBreakdown82
 Traction Control153
 Turn Signals47, 185
 Warning Instrument Cluster Descriptions78
- Loading Vehicle127, 128
 Capacities128
 Tires247
- Locks**
 Automatic Door35, 37
 Low Tire Pressure System164
 Lubrication, Body222
 Lug Nuts/Bolts261
- M**
- Maintenance Free Battery217
 Maintenance Schedule213
 Malfunction Indicator Light (Check Engine)81
 Manual
 Service269
 Manual Sliding Window62
 Methanol262
 Mirrors45
 Electric Remote46
 Exterior Folding46
- Heated47
 Outside46
 Rearview45, 186
- Modifications/Alterations**
 Vehicle8
 Monitor, Tire Pressure System164
 Mopar Parts268
 MP3 Control58
 Multi-Function Control Lever47
- N**
- New Vehicle Break-In Period89
- O**
- Occupant Restraints165
 Octane Rating, Gasoline (Fuel)262
 Oil Change Indicator71
 Reset71
 Oil, Engine220, 265
 Capacity264
 Checking217
 Dipstick217
 Disposal220
 Filter220
 Filter Disposal220
 Identification Logo220
 Materials Added To220
 Pressure Warning Light79
 Recommendation220, 264
 Synthetic220
 Viscosity264
 Oil Filter, Change220
 Oil Filter, Selection220
 Oil Pressure Light79

Onboard Diagnostic System85	R		Safety, Exhaust Gas185
Operating Precautions85	Radial Ply Tires251	Safety Information, Tire244
Operator Manual		Radiator Cap (Coolant Pressure Cap).225	Safety Tips183
Owner's Manual269	Radio		Schedule, Maintenance213
Outside Rearview Mirrors45, 46	Sound Setting147	Seat Belts166, 183
Overheating, Engine207	Radio Operation.150	Adjustable Shoulder Belt169
P		Rain Sensitive Wiper System53	Adjustable Upper Shoulder Anchorage169
Paint Care258	Rear Camera.123, 124	Adjustable Upper Shoulder Belt Anchorage169
Parking Brake89	Rear Cross Path157	Automatic Locking Retractor (ALR)170
ParkSense		Rear Emergency Braking.117	Child Restraints177
Front And Rear111	Rear ParkSense System111	Energy Management Feature170
ParkSense Active Park Assist.117	Rearview Mirror.45	Front Seat166, 167, 168
ParkSense System, Rear.111	Recreational Towing.133	Inspection183
Passing Light48	Reformulated Gasoline262	Lap/Shoulder Belt Operation168
Passive Entry.36	Refrigerant222	Lap/Shoulder Belts167
Pedestrian Warning System.151, 163	Release, Hood62	Lap/Shoulder Belt Untwisting168
Personal Settings.72	Reminder, Seat Belt166	Operating Instructions168
Pets183	Remote Control		Pregnant Women169
Placard, Tire And Loading Information247	Starting System32	Rear Seat167
Power		Remote Keyless Entry		Reminder166
Inverter59	Programming Additional Key Fobs28	Untwisting Procedure168
Mirrors46	Remote Starting		Seat Belts Maintenance259
Outlet (Auxiliary Electrical Outlet)58	Exit Remote Start Mode31, 33	Seats39
Steering97	Remote Starting System30, 32	Adjustment39
Windows61	Replacement Bulbs240	Heated41
Pregnant Women And Seat Belts.169	Replacement Keys28	Rear Folding39
Premium Instrument Cluster 67	Replacement Tires252	Tilting39
Preparation For Jacking189	Reporting Safety Defects268	Security Alarm34, 80
Q		Restraints, Child.177	Selection Of Coolant (Antifreeze).265
Quiet Vehicle Pedestrian Module (QVPM)151	Restraints, Head43	Sentry Key (Immobilizer)28
		Rotation, Tires256	Service Assistance266
		S		Service Contract267
		Safety Checks Inside Vehicle.183	Service Manuals269
		Safety Checks Outside Vehicle184	Settings	
		Safety Defects, Reporting268	Personal136
				Shift Lever Override208
				Shoulder Belts167
				Side Distance Warning115

- Signals, Turn185
 Snow Chains (Tire Chains)255
 Snow Tires253
 Spare Tires253, 254
 Speed Limiter, Active98
 Starting32, 87, 88
 Automatic Transmission87
 Button29
 Cold Weather87
 Engine Fails To Start87
 Remote32
 Steering38
 Column Lock38
 Power97
 Storage, Vehicle56, 257
 Storing Your Vehicle257
 Supplemental Restraint System – Air Bag172
 Surround View Camera124
 Sway Control, Trailer155
 Symbol Glossary8
 Synthetic Engine Oil220
 System, Remote Starting32
- T**
- Telescoping Steering Column38
 Tip Start87
 Tire And Loading Information Placard247
 Tire Markings244
 Tires184, 250, 253, 256
 Aging (Life Of Tires)252
 Air Pressure250
 Chains255
 Changing189
 Compact Spare253
 General Information250, 253
 High Speed250
- Inflation Pressure250
 Jacking189
 Life Of Tires252
 Load Capacity247
 Pressure Monitoring System (TPMS)82, 164
 Quality Grading256
 Radial251
 Replacement252
 Rotation256
 Safety244, 250
 Sizes245
 Snow Tires253
 Spare Tires253, 254
 Spinning251
 Trailer Towing131
 Tread Wear Indicators251
 Wheel Nut Torque261
- Tire Safety Information244
 Tire Service Kit194, 199, 200, 202
 Tire Service Kit – If Equipped 194
 Tongue Weight/Trailer Weight130
 To Open Hood62
 Towing128, 209
 Disabled Vehicle209
 Guide130
 Recreational133
 Weight130
 Towing Behind A Motorhome133
 Towing Eyes210
 Traction134
 Traction Control154
 Traffic Sign Assist106
 Trailer Sway Control (TSC)155
 Trailer Towing128
 Hitches129
 Minimum Requirements131
 Tips132
 Trailer And Tongue Weight130
- Wiring132
 Trailer Towing Guide130
 Trailer Weight130
- Transaxle**
- Automatic95
 Operation95
- Transmission**
- Automatic91, 227
 Fluid265
 Maintenance227
 Transmission Fault Warning Light79
 Transporting Pets183
 Tread Wear Indicators251
- U**
- Uconnect Settings
 Customer Programmable Features36, 136
 Passive Entry Programming36
 Uniform Tire Quality Grades256
 Unleaded Gasoline262
 Untwisting Procedure, Seat Belt168
 USB58
- V**
- Vehicle Certification Label127
 Vehicle Identification Number (VIN)261
 Vehicle Loading127, 128, 247
 Vehicle Modifications/Alterations8
 Vehicle Storage56, 257
 Voice Command44
 Voice Recognition System (VR)44

W

Warning Lights And Messages.77
Warning Lights (Instrument Cluster Descriptions). . .	.81
Warranty Information 268
Washer	
Adding Fluid217
Washing Vehicle.258
Water	
Driving Through134
Wheel And Wheel Tire Care254
Wheel And Wheel Tire Trim254
Wind Buffeting62
Window Fogging56
Windows61
Power61
Windshield Defroster184
Windshield Washers52, 217
Fluid52
Windshield Wiper Blades223
Windshield Wipers52
Wipers Blade Replacement223
Wipers, Intermittent.52
Wipers, Rain Sensitive53
Wireless Charging Pad60





The driver's primary responsibility is the safe operation of the vehicle. Driving while distracted can result in loss of vehicle control, resulting in an accident and personal injury. FCA US LLC strongly recommends that the driver use extreme caution when using any device or feature that may take their attention off the road. Use of any electrical devices, such as cellular telephones, computers, portable radios, vehicle navigation or other devices, by the driver while the vehicle is moving is dangerous and could lead to a serious accident. Texting while driving is also dangerous and should never be done while the vehicle is moving. If you find yourself unable to devote your full attention to vehicle operation, pull off the road to a safe location and stop your vehicle. Some states or provinces prohibit the use of cellular telephones or texting while driving. It is always the driver's responsibility to comply with all local laws.

This Owner's Manual has been prepared to help you get acquainted with your new Ram brand vehicle and to provide a convenient reference for common questions.

Not all features shown in this manual may apply to your vehicle. For additional information on accessories to help personalize your vehicle, visit mopar.com/om (USA), owners.mopar.ca (Canada) or your local Ram brand dealer.

This Owner's Manual is intended to familiarize you with the important features of your vehicle. Your most up-to-date Owner's Manual, Radio Instruction Manual and Warranty Booklet can be found by visiting the website on the back cover.

U.S. Residents: If you are the first registered retail owner of your vehicle, you may obtain a complimentary printed copy of the Warranty Booklet by calling **1-866-726-4636** or by contacting your dealer. Replacement kits can be purchased by visiting www.techauthority.com.

Canadian Residents: If you are the first registered retail owner of your vehicle, you may obtain a complimentary printed copy of the Warranty Booklet or purchase a replacement kit by calling **1-800-387-1143** or by contacting your dealer.

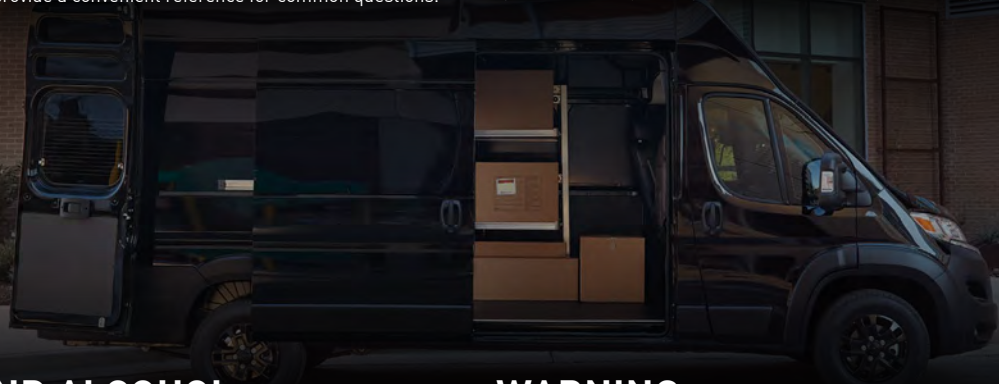

DRIVING AND ALCOHOL

Drunk driving is one of the most frequent causes of accidents. Your driving ability can be seriously impaired with blood alcohol levels far below the legal minimum. If you are drinking, don't drive. Ride with a designated non-drinking driver, call a cab, a friend or use public transportation.

WARNING

Driving after drinking can lead to an accident. Your perceptions are less sharp, your reflexes are slower and your judgment is impaired when you have been drinking. Never drink and then drive.



RAM
COMMERCIAL



The Ram app puts the latest in connectivity and convenience in the palm of your hand. The App provides access to your remote vehicle commands (if properly equipped), service history, My Garage and the Digital Glovebox. To get this app, go directly to the App Store® or Google Play® Store and enter the search keyword "Ram" (U.S. residents only).

**DOWNLOAD THE MOST UP-TO-DATE
OWNER'S MANUAL,
RADIO AND WARRANTY BOOKS**

U.S.



[MOPAR.COM/OM](https://mopar.com/om)

CANADA



[OWNERS.MOPAR.CA](https://owners.mopar.ca)